

新品和推广用产品 2022



自调式 - 握紧 - 夹紧 - Joker 6004 现在也在 VDE 中。

- 内含 4 把可调节 Joker 6004 VDE 的紧凑型帆布工具袋，涵盖了 7 至 19mm 或 $\frac{1}{4}$ " 至 $\frac{3}{4}$ " 的所有公制和英制尺寸的应用
- 带有绝缘手柄的单独测试工具，用于安全工作，工作电压不超过 1,000 伏，具有防滑保护功能，可安全打开非绝缘钳口
- 自动和连续夹紧六角螺钉或螺栓
- 避免在夹紧过程中产生打滑和损坏的杠杆机构
- 借助杠杆棘轮功能，无需取下扳手便可快速流畅完成螺丝紧固工序
- 开口凹槽设计实现 30° 回转角





13 10
1/2 7/16

Wera

Joker

6004 VDE S

6004 Joker VDE XS VDE 绝缘自调式扳手



应用：六角螺帽和螺栓，带尺寸为 7-10 (公制) 或 1/4"-3/8" (英制) 的扳手

	mm	mm	mm	mm
05020150001	7-10	1/4"-3/8"	119	7,7

2023年1月上市

6004 Joker VDE S VDE 绝缘自调式扳手



应用：六角螺帽和螺栓，带尺寸为 10-13 (公制) 或 7/16"-1/2" (英制) 的扳手

	mm	mm	mm	mm
05020151001	10-13	7/16"-1/2"	155	10

2023年1月上市

6004 Joker VDE M VDE 绝缘自调式扳手



应用：六角螺帽和螺栓，带尺寸为 13-16 (公制) 或 1/2"-5/8" (英制) 的扳手

	mm	mm	mm	mm
05020152001	13-16	1/2"-5/8"	190	12,4

2023年1月上市



6004 Joker VDE L VDE 绝缘自调式扳手



应用：六角螺帽和螺栓，带尺寸为 16-19 (公制) 或 5/8"-3/4" (英制) 的扳手

	mm	mm	mm	mm
05020153001	16-19	5/8"-3/4"	226	14

2023年1月上市

Joker 6004 VDE : 自动持续自调式



Joker 6004 VDE 扳手自动且持续地握住平行卡爪, 覆盖了潜在工作范围内的所有尺寸。将工具连接到螺栓或螺丝上时, 工具本身即可找到所需尺寸。

Joker 6004 VDE : 轻柔地应用于螺丝

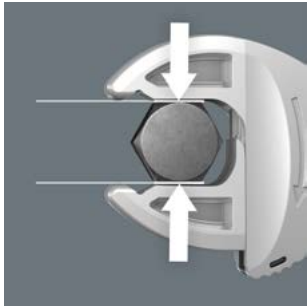

Joker 6004 VDE 的平行、光滑钳口提供了座合应力, 因此可以防止螺母或螺丝头钝化, 这可能发生在通过角落输送电力时。

Joker 6004 VDE : 快速工作棘轮机构



开口的棘轮功能快速拧紧螺丝, 无任何滞顿。

Joker 6004 VDE : 低反向旋转角度

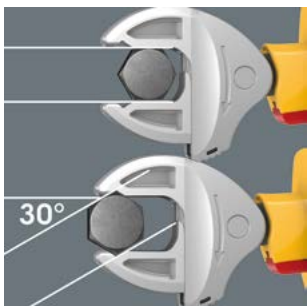

开口凹槽实现 30° 的回转角度。

安全打开钳口

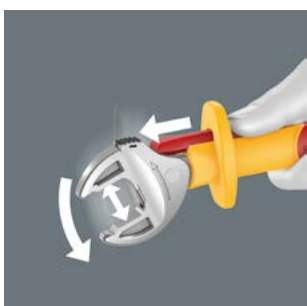

滑动功能为非绝缘钳口提供了无触点安全开口。

6004 Joker VDE 4 组套 1 VDE 绝缘自调式扳手套组



VDE 绝缘自调式扳手套组
4 件组套
采用坚固的帆布工具袋子

05020170001		
6004 Joker VDE XS	1x 7-10 (1/4"-3/8")	x119
6004 Joker VDE S	1x 10-13 (7/16"-1/2")	x155
6004 Joker VDE M	1x 13-16 (1/2"-5/8")	x190
6004 Joker VDE L	1x 16-19 (5/8"-3/4")	x226
K 120	1x 50,0x120,0	

2023年1月上市



绝缘强度测试



按照 IEC 60900 的标准, 每件工具都必须通过 10,000 伏的绝缘性能测试, 保证其在 1,000 伏的环境下能安全工作。

全新Zyklop棘轮，带有组合式批头库和组合式批头和套筒安装。

- 紧凑型 Zyklop 棘轮，带集成式批头库
- 磁性插座同时将 $\frac{3}{8}$ " 棘轮变成 $\frac{1}{4}$ " 批头安装架的棘轮螺丝刀
- 可自由转动的棘轮头，带5种预设的锁定位置
- 细齿可逆棘轮（72齿），低回转角仅 5°
- 固定式和旋转式批头库，便于批头的拆卸和安全存放





8009 Zyklop 随身袋组套 1



13 件组套；用于 $\frac{3}{8}$ " 套筒以及 $\frac{3}{8}$ " 方头驱动插件的 1 个 Zyklop 随身袋 8009；也适用于符合 DIN ISO 1173-C 6.3 和 E 6.3 的带 $\frac{1}{4}$ " 外六角驱动的批头以及 Wera 连接系列 1 和 4 的 $\frac{3}{8}$ " 棘轮和 $\frac{1}{4}$ " 批头棘轮螺丝刀；可自由旋转棘轮头；左右 0° 、 15° 和 90° 可预设角度；可在 0° 位置用作常规螺丝刀；可顺时针/逆时针切换、细齿、小回转角 5° ；磁性插座。用于省力的多重材料 Kraftform 手柄；固定、轮转式批头仓，手柄内藏 12 个批头， $\frac{1}{4}$ "，长 25 mm。

05004280001		
8009	1x $\frac{3}{8}$ "x $\frac{1}{4}$ "x133,0	
851/1 BTZ	1x PH 1x25; 1x PH 2x25	
855/1 BTZ	1x PZ 1x25; 1x PZ 2x25	
867/1 TORX® BTZ	1x TX 10x25; 1x TX 15x25; 1x TX 20x25; 1x TX 25x25	
840/1 BTZ	1x 3,0x25; 1x 4,0x25; 1x 5,0x25; 1x 6,0x25	

8009 Zyklop 随身袋组套 Imperial 1



05004282001		
8009	1x $\frac{3}{8}$ "x $\frac{1}{4}$ "x133,0	
851/1 BTZ	1x PH 1x25; 1x PH 2x25	
867/1 TORX® BTZ	1x TX 10x25; 1x TX 15x25; 1x TX 20x25; 1x TX 25x25	
840/1 Z	1x $\frac{1}{8}$ "x25; 1x $\frac{9}{32}$ "x25; 1x $\frac{3}{16}$ "x25; 1x $\frac{1}{4}$ "x25	
868/1 Z	1x # 1x25; 1x # 2x25	



COMBINATION DRIVE

组合工具安装



磁性直接安装架适用于 $\frac{3}{8}$ " 套筒以及 $\frac{1}{4}$ " 批头。

8009 Zyklop 随身袋组套 2



18 件组套；用于 $\frac{3}{8}$ " 套筒以及 $\frac{3}{8}$ " 方头驱动插件的 1 个 Zyklop 随身袋 8009；也适用于符合 DIN ISO 1173-C 6.3 和 E 6.3 的带 $\frac{1}{4}$ " 外六角驱动的批头以及 Wera 连接系列 1 和 4 的 $\frac{3}{8}$ " 棘轮和 $\frac{1}{4}$ " 批头棘轮螺丝刀；可自由旋转棘轮头；左右 0° 、 15° 和 90° 可预设角度；可在 0° 位置用作常规螺丝刀；可顺时针/逆时针切换、细齿、小回转角 5° ；磁性插座。用于省力的多重材料 Kraftform 手柄；固定、轮转式批头仓，手柄内藏 12 个批头， $\frac{1}{4}$ "，长 25 mm；带不锈钢衬套和强磁接杆（75 mm 长），适用于按照 DIN ISO 1173-C 6.3 和 Wera 连接系列 1 安装带 $\frac{1}{4}$ " 外六角驱动的批头；3 个 Zyklop 套筒， $\frac{3}{8}$ "；坚固的帆布工具组套 9468，可以夹在皮带上并停靠在 Wera 2go 系统上。

05004281001		
8009	1x $\frac{3}{8}$ "x $\frac{1}{4}$ "x133,0	
893/1/1	1x $\frac{1}{4}$ "x75	
851/1 BTZ	1x PH 1x25; 1x PH 2x25	
855/1 BTZ	1x PZ 1x25; 1x PZ 2x25	
867/1 TORX® BTZ	1x TX 10x25; 1x TX 15x25; 1x TX 20x25; 1x TX 25x25	
840/1 BTZ	1x 3,0x25; 1x 4,0x25; 1x 5,0x25; 1x 6,0x25	
8790 HMB	1x 8,0x29,0; 1x 10,0x29,0; 1x 13,0x29,0	
9468	1x 155,0x65,0	
K 70	1x 50,0x70,0	



8009 Zyklop 随身袋组套 Imperial 2



18 件组套；用于 $\frac{3}{8}$ " 套筒以及 $\frac{3}{8}$ " 方头驱动插件的 1 个 Zyklop 随身袋 8009；也适用于符合 DIN ISO 1173-C 6.3 和 E 6.3 的带 $\frac{1}{4}$ " 外六角驱动的批头以及 Wera 连接系列 1 和 4 的 $\frac{3}{8}$ " 棘轮和 $\frac{1}{4}$ " 批头棘轮螺丝刀；可自由旋转棘轮头；左右 0° 、 15° 和 90° 可预设角度；可在 0° 位置用作常规螺丝刀；可顺时针/逆时针切换、细齿、小回转角 5° ；磁性插座。用于省力的多重材料 Kraftform 手柄；固定、轮转式批头仓，手柄内藏 12 个批头， $\frac{1}{4}$ "，长 25 mm；带不锈钢衬套和强磁接杆（75 mm 长），适用于按照 DIN ISO 1173-C 6.3 和 Wera 连接系列 1 安装带 $\frac{1}{4}$ " 外六角驱动的批头；3 个 Zyklop 套筒， $\frac{3}{8}$ "；坚固的帆布工具组套 9468，可以夹在皮带上并停靠在 Wera 2go 系统上。

05004283001		
8009	1x $\frac{3}{8}$ "x $\frac{1}{4}$ "x133,0	
893/1/1	1x $\frac{1}{4}$ "x75	
851/1 BTZ	1x PH 1x25; 1x PH 2x25	
867/1 TORX® BTZ	1x TX 10x25; 1x TX 15x25; 1x TX 20x25; 1x TX 25x25	
840/1 Z	1x $\frac{1}{8}$ "x25; 1x $\frac{5}{32}$ "x25; 1x $\frac{3}{16}$ "x25; 1x $\frac{1}{4}$ "x25	
868/1 Z	1x # 1x25; 1x # 2x25	
8790 HMB	1x $\frac{5}{16}$ "x29,0; 1x $\frac{3}{8}$ "x29,0; 1x $\frac{1}{2}$ "x29,0	
9468	1x 155,0x65,0	
K 70	1x 50,0x70,0	

带集成式批头库

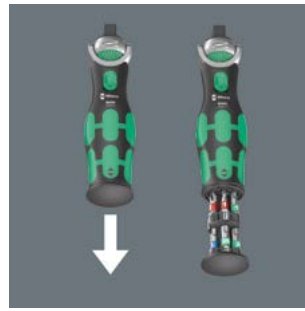

紧凑棘轮头的手柄集成了一个 12 个批头 ($\frac{1}{4}$ "，25 mm 长) 的自由旋转批头库。

旋转式批头库



旋转式批头库让您能在几乎任何情况下轻易拔掉批头，并且不会丢失。批头安全存放。

轻松切换方向



Zyklop 随身袋棘轮可以使用滚花在任何位置快速、轻松地逆转，以便顺时针/逆时针旋转。

可自由转动的棘轮头

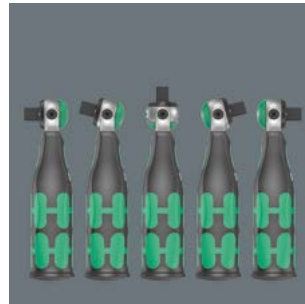

棘轮头可 180° 自由转动，并可通过两侧的滑动开关锁定在任何位置。它可以在只能容纳手的狭小区域工作。左右两边的 $0^\circ/15^\circ/90^\circ$ 上的保险槽可确保棘轮头不会滑动，以保障工作安全。

皮带套



坚固的皮套可以夹在皮带上。

外出时的极限自行车组：轻量级，紧凑型，具有许多功能。



- 创新性、极为紧凑的四头批头 - 四种不同的螺丝尺寸仅有一个批头
- 非常节省空间，因此是移动使用的理想选择
- Wera 轮胎千斤顶紧凑、安全、简易的保持器
- 轮胎千斤顶的六角形安装允许扭矩高达 10 Nm
- 大幅度节省重量和更好地概述参观时的工具





自行车组套 15

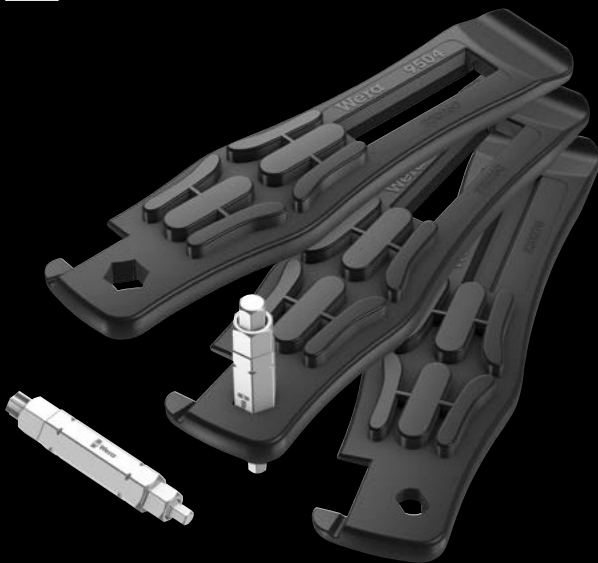

5 件组套

配玻璃纤维加固塑料轮胎千斤顶，轮胎可以安全脱离轮辋而不损坏轮辋。

2 个 9504 轮胎千斤顶，配 1/4" 批头插座

1 个 9505 轮胎千斤顶，配法式阀门 (Sclaverand) 的顶出阀和汽车阀门的放气阀

内六角螺丝尺寸 3.0、4.0、5.0、6.0 的 1 个批头 9506 (4 合 1)

内六角螺丝尺寸 2.5、5.0、6.0 和 TORX® 梅花螺丝尺寸 TX 25 的 1 个批头 9507 (4 合 1)

05004182001		
	9504	2x 105,0
	9505	1x 105,0
⊙⊙	9506	1x 3,0; 4,0; 5,0; 6,0x37
⊙⊙	9507	1x 2,5; 5; 6; TX 25x37

轮胎可以安全脱离轮辋



配玻璃纤维加固塑料轮胎千斤顶，轮胎可以安全脱离轮辋而不损坏轮辋。凭借轮胎千斤顶，轮胎可以安全脱离轮辋，钩入辐条，随后用第二个轮胎千斤顶拉出轮胎。两个轮胎千斤顶可以连接在一起，不会单独丢失。

9504 轮胎千斤顶，可兼当批头扳手



9504 轮胎千斤顶上的 1/4" 六角形安装架可以安装一个 1/4" 的批头，以便于连接。

9505 轮胎千斤顶



9505 轮胎千斤顶可用作法式阀门 (Sclaverand) 的顶出阀和汽车阀门的放气口。

Wera 4 合 1 批头

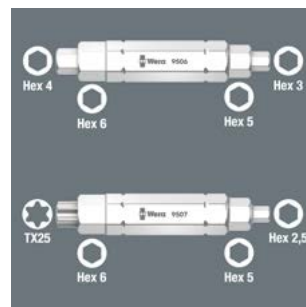

4 个螺丝尺寸可以使用 4 合 1 批头 9506 和 9507 进行操作。用于四种尺寸内六角螺丝 (3.0、4.0、5.0、6.0) 的 4 合 1 位 9506，用于三种尺寸内六角螺丝 (2.5、5.0、6.0) 和一种尺寸 TORX® 梅花螺丝 (TX 25) 的 4 合 1 批头 9507。为了使用较大的型材，在旋拧时不断按压弹簧张力，可缩入较小花形，并使用较大花形。



扭矩扳手不能过度拧紧，应采用停用设置作为棘轮。



- 滑脱释放机构 - 设定扭矩切勿过度拧紧
- 扭矩锁定功能：扭矩设定功能可以停用，然后工具可用作具有高松动扭矩的标准棘轮，并可用于具有规定旋转角度的应用程序
- 针对可控顺时针和逆时针扭矩操作 - 扭力设定可开关
- 易于设置和储存所需扭矩值，当调到刻度值
- 达到目标扭矩后，释放角度仅为30°
- 72 齿细齿机构，5° 较小回转角



滑动机构防止打过扭矩



Safe-Torque A 1 扭矩扳手配有防超扭滑动机构。达到设定扭矩后，不能对工具进行过度拧紧，以免施加过度扭矩。

扭矩锁定功能



扭矩功能可以停用。

扭矩锁定功能



然后，Safe-Torque 扳手也可用作具有高松动扭矩的标准棘轮，并可用于具有规定旋转角度的应用。

针对顺时针和逆时针运行



Safe-Torque 扳手适用于设定扭矩的顺时针和逆时针操作。扭矩锁功能停用时，无需扭矩即可进行紧固松动。

扭矩设置简单



通过声音和触觉点击达到刻度值，轻松设置和保存所需扭矩。

1/4" 套筒



Safe-Torque A 1 扭矩扳手有 1/4" 方头安装架, 适用于 1/4" 套筒。

球锁



球锁确保了套筒和配件的安全座位, 因此在旋拧过程中也是可靠的安全。短按棘轮头上的释放按钮, 球锁即释放。

能容纳更多工具的空间



Wera 带可以连接到 Safe-Torque A 1 组套 1 和 Safe-Torque A 1 Imperial 组套 1 的帆布工具袋中的魔术贴条上, 这样可以储存和运输更多的套筒和/或批头套筒。



带 1/4" 方头驱动的 Safe-Torque A 1 扭矩扳手, 2-12 Nm

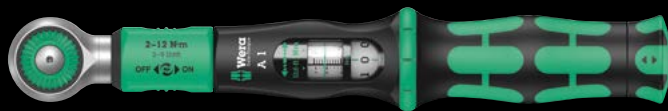

应用: 用于顺时针和逆时针方向控扭矩操作; 扭力设定可开关

扭矩范围: 2-12 Nm

适用于: 1/4" 套筒

精密度: 精度±设定值的10%

设计: 1/4" 方头驱动、扭矩扳手、可开关式扭矩设定功能: 72齿, 回转角5°, 可方便地设置和保存所需扭矩值, 达到刻度值后有声音和触觉反馈, 达到设定扭矩后空转构造

手柄: 人体工学双重材料手柄

	Nm	Nm	lbf. ft.	mm	mm	mm	mm	mm	mm	mm	mm	mm	mm
0507580001	1/4"	2-12	0,10	2-9	244	94	38,5	31,6	23,7	9 39/64"	3 45/64"	1 33/64"	1 15/64"



10 件 1/4" 扭矩扳手组套装入坚固的帆布工具袋内；扭矩扳手带滑动机构。达到设定扭矩后，不能对工具进行过度拧紧，以免施加过度扭矩。

可换向控制运行设定范围为2-12 Nm。易于设置并保存默认数值：达到刻度值时产生清晰的咔哒接触感，有助于安全设置所需的扭矩值。不带扭矩功能的标准棘轮使用扭矩锁功能。因此，也可用于旋转角度的应用。

根据DIN 3122，1/4" 方头的最大开断扭矩。只有5°的回转角允许棘轮即使在受限空间内也可以使用。含：Safe-Torque A 1个扭矩扳手，方头1/4"，2-12 Nm，8个套筒，驱动1/4"，一根短延长杆。

Safe-Torque A 1 组套 1，1/4"方头，2-12 Nm



Safe-Torque A 1 Imperial 组套 1，1/4" 方头，2-12 Nm



05075830001	
○	Safe-Torque A 1 1x 1/4", 2-12 Nm
●	8790 HMA 1x 5,5x23,0; 1x 6,0x23,0; 1x 7,0x23,0; 1x 8,0x23,0; 1x 10,0x23,0; 1x 11,0x23,0; 1x 12,0x23,0; 1x 13,0x23,0
○ □	8794 SA 1x 1/4"x75,0
	K 240 1x 50,0x240,0

05075831001	
○	Safe-Torque A 1 1x 1/4", 2-12 Nm
●	8790 HMA 1x 3/16"x23,0; 1x 7/32"x23,0; 1x 1/4"x23,0; 1x 9/32"x23,0; 1x 5/16"x23,0; 1x 3/8"x23,0; 1x 7/16"x23,0; 1x 1/2"x23,0
○ □	8794 SA 1x 1/4"x75,0
	K 240 1x 50,0x240,0



带 1/4" 六角驱动的 Safe-Torque A 2 扭矩扳手，2-12 Nm

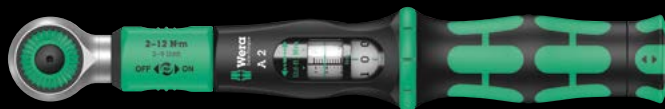

应用： 用于顺时针和逆时针方向控扭矩操作；扭力设定可开关

扭矩范围： 2-12 Nm

适用于： 符合DIN ISO 1173-C 6.3和E 6.3要求的带1/4" 外六角驱动头的批头，以及 Wera 连接系列1、4设计

精密密度： 精度±设定值的10%

设计： 1/4"内六角螺丝驱动、扭矩扳手、可开关式扭矩设定功能：72齿，回转角5°，可方便地设置和保存所需扭矩值，达到刻度值后有声音和触觉反馈，达到设定扭矩后空转构造

手柄： 人体工学双重材料手柄

	Nm	Nm	lbf. ft.	mm	mm	mm	mm	mm	mm	mm	mm	mm	mm	mm	mm
05075801001	1/4"	2-12	0,10	2-9	244	94	38,5	31,6	23,7	9 39/64"	3 45/64"	1 39/64"	1 15/64"	15/16"	

Safe-Torque A 2 组套 1, 1/4" 内六角, 2-12 Nm

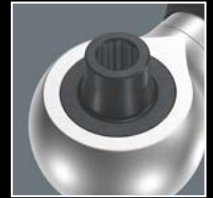

23 件组套；收放于触感滑顺、节省空间且坚固耐用的帆布工具袋内。尺寸小，重量轻，便携。

1 个 Safe-Torque A 2 扭矩扳手，1/4" 内六角驱动，扭矩设定范围 2-12 Nm；用于顺时针和逆时针方向的扭矩操作；拧紧松动，可开关式扭矩设定功能；72 齿；5° 回转角；设定和保存所需扭矩值容易，达到刻度值时有声音和触觉反馈，达到设定扭矩时空转构造；人体工学双重材料手柄；9 个 Zyklop 套筒，12 个耐用批头（1/4"，50 mm 长），套筒的一个连接部分（1/4" 外六角至 1/4" 外四角）

05075832001	
●	Safe-Torque A 2 1x 1/4", 2-12 Nm
●	8790 HMA 1x 5,5x23,0; 1x 6,0x23,0; 1x 7,0x23,0; 1x 8,0x23,0; 1x 9,0x23,0; 1x 10,0x23,0; 1x 11,0x23,0; 1x 12,0x23,0; 1x 13,0x23,0
○ ○	870/1 1x 1/4"x25 ¹⁾
⊕	851/4 Z 1x PH 2x50
⊗	867/4 Z TORX® 1x TX 10x50; 1x TX 15x50; 1x TX 20x50; 1x TX 25x50; 1x TX 27x50; 1x TX 30x50
○	840/4 Z 1x 2,5x50; 1x 3,0x50; 1x 4,0x50; 1x 5,0x50; 1x 6,0x50
	K 240 1x 50,0x240,0

¹⁾ 带摩擦球，用于手动螺母扳手套筒

对于 1/4" 批头



Safe-Torque A 2 扭矩扳手有 1/4" 批头安装架，有强大的永久磁铁，适用于符合 DIN ISO 1173-C 6.3 和 E 6.3 要求的带 1/4 外六角驱动头的批头，以及 Wera 连接系列 1 和 4 设计。

1/4" 套筒扳手嵌件转接头



使用 870/1 连接器（1/4" 外六角至 1/4" 外四角）时，Safe-Torque A 2 也可与 1/4" 套筒扳手嵌件一起使用。

最终开发出：用于非常艰巨的旋拧作业的刀杆组。

- 松紧螺丝连接处
- 手动冲击扳手功能可开关
- 锤击冲击波转化为旋转运动，松弛扭矩约为25 Nm – 无磅推力刀杆损耗
- 可逆功能：冲击扳手及螺丝刀
- 结合了手动冲击扳手、紧凑工具和螺丝刀与磅推力刀杆的优势





Kraftform Kompakt 900 组套 1



带1个冲击螺丝刀921和18个冲击螺
丝刀头(长 70 mm)的19件套帆布工具袋

05018110001		
921	1x 1/4"x163,5	
851 S	1x PH 1x70; 1x PH 2x70; 1x PH 3x70	
855 S	1x PZ 1x70; 1x PZ 2x70; 1x PZ 3x70	
867 S TORX®	1x TX 15x70; 1x TX 20x70; 1x TX 25x70; 1x TX 30x70; 1x TX 40x70	
840 S Hex-Plus	1x 3,0x70; 1x 4,0x70; 1x 5,0x70; 1x 6,0x70	
800 S	1x 0,8x4,0x70; 1x 1,0x5,5x70; 1x 1,2x6,5x70	
K 120	1x 50,0x120,0	

Kraftform Kompakt 900 Imperial 组套 1



带1个冲击螺丝刀921和18个冲击螺
丝刀头(长 70 mm)的19件套帆布工具袋

05018111001		
921	1x 1/4"x163,5	
851 S	1x PH 1x70; 1x PH 2x70; 1x PH 3x70	
867 S TORX®	1x TX 15x70; 1x TX 20x70; 1x TX 25x70; 1x TX 30x70; 1x TX 40x70	
840 S Hex-Plus	1x 1/8"x70; 1x 5/32"x70; 1x 3/16"x70; 1x 1/4"x70	
868 S	1x # 1x70; 1x # 2x70; 1x # 3x70	
800 S	1x 0,8x4,0x70; 1x 1,0x5,5x70; 1x 1,2x6,5x70	
K 120	1x 50,0x120,0	

921 Kraftform Plus 冲击螺丝刀 - 900系列



应用: 适用于带 1/4" 外六角尖头的冲击扳手批头
设计: 冲击扳手/螺丝刀切换功能; 磅推刀杆; 1/4" 内六角套筒安装, 磁力
手柄: Kraftform 配六角防滚动保护, 多重材料

05018100001		
1/4"	163,5	6 7/16"

868 S 冲击螺丝刀方头套筒

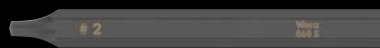

应用: 方头套筒螺丝; 用于冲击螺丝刀921
驱动: 1/4" 内六角
设计: 特硬

	□	∅	∅
		mm	
05018171001	# 1	70	2 3/4"
05018172001	# 2	70	2 3/4"
05018173001	# 3	70	2 3/4"

867 S TORX® 冲击螺丝刀批头



应用： TORX® 套筒螺丝；用于冲击螺丝刀921

驱动： 1/4" 内六角

设计： 特硬

		mm	英寸
05018166001	TX 15	70	2 3/4"
05018167001	TX 20	70	2 3/4"
05018168001	TX 25	70	2 3/4"
05018169001	TX 30	70	2 3/4"
05018170001	TX 40	70	2 3/4"

851 S 冲击螺丝刀十字批头

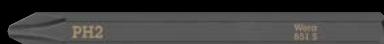

应用： Phillips-Recess 十字头螺丝；用于冲击螺丝刀921

驱动： 1/4" 内六角

设计： 特硬

		mm	英寸
05018160001	PH 1	70	2 3/4"
05018161001	PH 2	70	2 3/4"
05018162001	PH 3	70	2 3/4"

855 S PZ 米字冲击螺丝刀批头

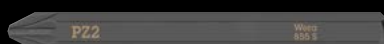

应用： 适用于PZ米字螺丝；用于冲击螺丝刀921

驱动： 1/4" 内六角

设计： 特硬

		mm	英寸
05018163001	PZ 1	70	2 3/4"
05018164001	PZ 2	70	2 3/4"
05018165001	PZ 3	70	2 3/4"

组合工具

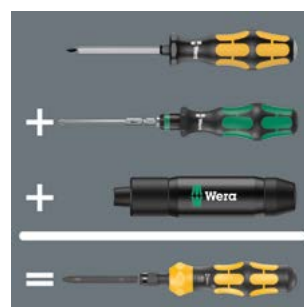

921 冲击螺丝刀结合了刀片组、凿子和手动冲击扳手的优点。

一把手柄配多个可更换式刀杆

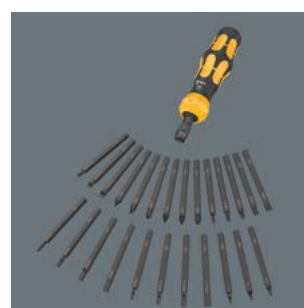

坚固批头支座适用于1/4" 外六角驱动批头，符合 DIN ISO 1173-C 6.3 和 E 6.3。可互换的刀杆系统对使用者意味着重量轻、空间要求减少、灵活性高。



冲击扳手功能可开关



如果需要松开甚至顽固的螺丝连接，则可以打开手动冲击扳手功能。



松弛扭矩

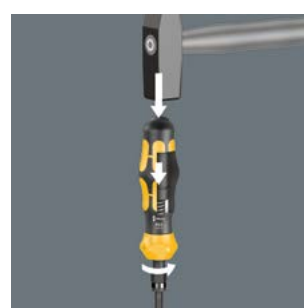

当冲击扳手功能开启时，锤击冲击脉冲转换为旋转运动，松动扭矩高达25 Nm。通过磅推力刀杆进行无损耗的功率传输。

840 S Hex-Plus 冲击螺丝刀批头



应用：内六角螺丝；用于冲击螺丝刀921

驱动：1/4" 内六角

设计：Hex-Plus, 特硬

	⊙	⊙	⌈	⌈
	mm		mm	
05018150001	3,0		70	2 3/4"
05018151001	4,0		70	2 3/4"
05018152001	5,0		70	2 3/4"
05018153001	6,0		70	2 3/4"
05018154001		1/8"	70	2 3/4"
05018155001		5/32"	70	2 3/4"
05018156001		3/16"	70	2 3/4"
05018157001		1/4"	70	2 3/4"

800 S 冲击螺丝刀一字批头



应用：一字螺丝；用于冲击螺丝刀921

驱动：1/4" 六角形

设计：特硬

	⌋	⌋	⌈	⌈
	mm	mm	mm	
05018140001	0,8	4,0	70	2 3/4"
05018141001	1,0	5,5	70	2 3/4"
05018142001	1,2	6,5	70	2 3/4"





从手柄发出轻微的棘轮声音。



棘轮功能

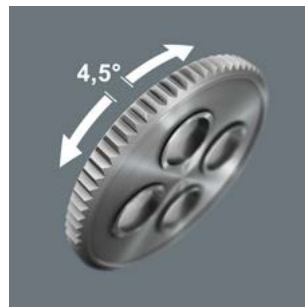

带有细齿的集成棘轮 (80 齿) 和回转角 4.5° 可以在不需要重新定位工具的情况下放松和加速螺丝刀的驱动。

手柄棘轮机构

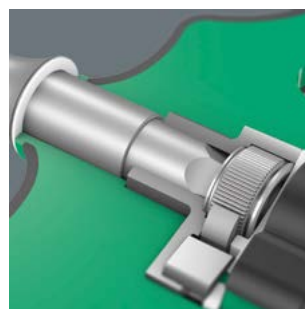

416 RA T 型柄插换式螺丝刀的棘轮机构完全嵌入在手柄中。工具形状紧凑，工作方便。

可逆顺时针/逆时针

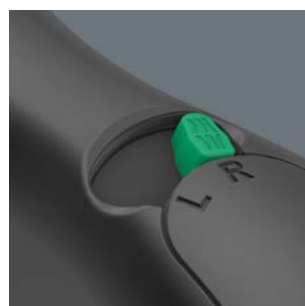

使用转向杆可以很容易地改变方向。

- 细齿集成棘轮保证快速安全工作
- 方便改变顺时针/逆时针方向的转向杆
- 棘轮机构完全嵌入手柄，方便工作
- 符合人体工程学的双重材料手柄，手指握柄和舒适的手感，能最大程度传输扭力，缓解作业疲劳
- 极高工作速度的快速旋转套筒
- 带快速旋转套筒的快速锁紧螺丝刀，用于快速更换雷电位和高工作速度
- 符合ISO 1173-C 6.3和E 6.3标准的1/4" 外六角驱动批头



Kraftform Kompakt 400 RA 组套 1



17 件组套

带有一个 416 RA T 型柄带棘轮功能的插换式螺丝刀和快速脱落夹持的帆布工具袋，16个硬批头，1/4"，长 89 mm

05023471001		
⊙	416 RA	1x 1/4"x45
⊕	851/4 Z	1x PH 2x89; 1x PH 3x89
⊕	855/4 Z	1x PZ 2x89; 1x PZ 3x89
⊗	867/4 Z TORX®	1x TX 10x89; 1x TX 15x89; 1x TX 20x89; 1x TX 25x89; 1x TX 30x89; 1x TX 40x89
○	840/4 Z	1x 3,0x89; 1x 4,0x89; 1x 5,0x89; 1x 6,0x89; 1x 8,0x89
⊖	800/4 Z	1x 1,0x5,5x89
	K 120	1x 50,0x120,0

Kraftform Kompakt 400 RA Imperial 组套 1



17 件组套

带有一个 416 RA T 型柄带棘轮功能的插换式螺丝刀和快速脱落夹持的帆布工具袋，16个硬批头，1/4"，长 89 mm

05057473001		
⊙	416 RA	1x 1/4"x45
⊕	851/4 Z	1x PH 2x89; 1x PH 3x89
⊗	867/4 Z TORX®	1x TX 10x89; 1x TX 15x89; 1x TX 20x89; 1x TX 25x89; 1x TX 30x89; 1x TX 40x89
○	840/4 Z	1x 1/8"x89; 1x 3/32"x89; 1x 3/16"x89; 1x 7/32"x89; 1x 1/4"x89
□	868/4	1x # 2x89; 1x # 3x89
⊖	800/4 Z	1x 1,0x5,5x89
	K 120	1x 50,0x120,0



具有棘轮功能和 Rapidaptor 快速释放夹持的 416 RA T 型柄插换式螺丝刀



应用： 适用于符合 DIN ISO 1173-C 6.3 和 E 6.3 要求的带 1/4" 外六角驱动头的批头，以及 Wera 连接系列 1、4

设计： 手柄（80 齿，回转角 4.5°）和换向拨杆内置细齿棘轮；根据 DIN ISO 1173-C 6.3 和 E 6.3 及 Wera 系列 1 和 4，采用 1/4" 外六角驱动批头，采用快进、快出、快速旋转、夹持和单手插换的 Rapidaptor 技术，安装 1/4" 六角套筒

手柄： T形，双重材料，悬挂孔

	mm	mm	mm		
05023461001	1/4"	45	44	99	1 25/32"

快速转动套筒



快速旋转套筒可使工具安全导向，同时旋转并提高工作速度。

全系夹持



可用于 DIN ISO 1173-C 6,3 和 E 6,3 标准的 1/4" 驱动批头，以及维拉系列 1 和 4 的批头。

- 细齿集成棘轮保证快速安全工作
- 方便改变顺时针/逆时针方向的转向杆
- 棘轮机构完全嵌入手柄，方便工作
- 符合人体工程学的双重材料手柄，手指握柄和舒适的手感，能最大程度传输扭力，缓解作业疲劳
- 极高工作速度的快速旋转套筒
- 带固定球锁的 1/4" 套筒安装架



Kraftform Kompakt 400 RA 组套 2

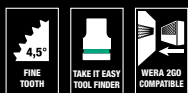

9 件组套，含坚固工具袋。一个具有棘轮功能的 411 A RA T 型柄螺丝刀适配器，1/4" 套筒。8 件套筒，1/4" 驱动，配“易寻”色标系统：用特定颜色代表不同尺寸。

Kraftform Kompakt 400 RA Imperial 组套 2

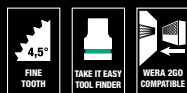

9 件组套，含坚固工具袋。一个具有棘轮功能的 411 A RA T 型柄螺丝刀适配器，1/4" 套筒。8 件套筒，1/4" 驱动，配“易寻”色标系统：用特定颜色代表不同尺寸。

05023470001		
○	411 A RA	1x 1/4"x45
●	8790 HMA	1x 6,0x23,0; 1x 7,0x23,0; 1x 8,0x23,0; 1x 9,0x23,0; 1x 10,0x23,0; 1x 11,0x23,0; 1x 12,0x23,0; 1x 13,0x23,0
	K 120	1x 50,0x120,0

05057474001		
○	411 A RA	1x 1/4"x45
●	8790 HMA	1x 3/16"x23,0; 1x 7/32"x23,0; 1x 1/4"x23,0; 1x 9/32"x23,0; 1x 5/16"x23,0; 1x 3/8"x23,0; 1x 7/16"x23,0; 1x 1/2"x23,0
	K120	1x 50,0x120,0

具有棘轮功能的 411 A R A T 型柄螺丝刀适配器，1/4"



应用： 带方头驱动的 1/4" 套筒和 1/4" 插件；含球锁

设计： 手柄 (80 齿, 回转角 4.5°) 和换向拨杆内置细齿棘轮；快速旋转套筒

手柄： T形, 双重材料, 悬挂孔

		mm	mm	mm	
05023460001	1/4"	45	44	99	1 25/32"

8790 C Impaktor Deep 组套 1

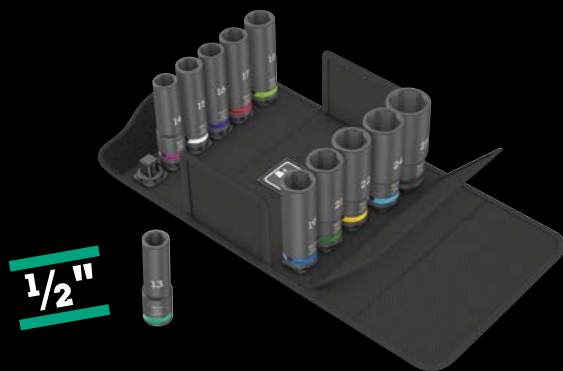

11 件组套；收放于触感滑顺、节省空间且坚固耐用的帆布工具袋内。尺寸小, 重量轻, 便携。

带 1/2" 驱动的 11 Impaktor 冲击套筒；适合采用电动或气动扳手的应用, 12.5 mm = 1/2" 驱动；带锁紧销孔；加长设计用于难以触及的接头和长螺杆；六角；铬钼材质；亚光黑色。“易寻”色标系统：按尺寸和花形进行颜色编码，以便快速和容易地识别所需的批头套筒。

05004841001			
	8790 C Impaktor Deep	1x 13,0x83,0; 1x 14,0x83,0; 1x 15,0x83,0; 1x 16,0x83,0; 1x 17,0x83,0; 1x 18,0x83,0; 1x 19,0x83,0; 1x 21,0x83,0; 1x 22,0x83,0; 1x 24,0x83,0; 1x 27,0x83,0	

快速转动套筒

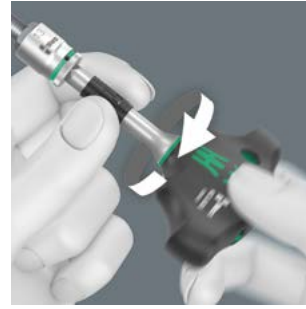

快速旋转套筒可使工具安全导向, 同时旋拧并提高工作速度。

含 1/4" 外四角螺丝



411 A R A T 型柄适用于 1/4" 套筒扳手嵌件。套筒扳手通过球牢固锁紧。

8790 C Impaktor Deep Set 1



适用于电动或气动冲击型工具



极其坚固的锻造设计确保了 Impaktor 插座即使在极端条件下也具有高于平均水平的使用寿命。

加长型设计



套筒采用加长型设计, 因此也可在狭小空间内完成紧固操作。也适合应用于凸头螺纹杆。

车间手推车配备齐全，车头设计精美，质量上乘。

- **Tool Rebel** 设计中的专用车间手推车
- 由于双面设计，设计极为坚固
- 有 7 个抽屉（5 个平，2 个高），其中 2 个扁平抽屉配备有泡垫和工具
- 扁平抽屉尺寸（宽x高x深）：**522 x 81 x 398 mm**
- 高抽屉尺寸（宽x高x深）：**522 x 166 x 398 mm**
- **100%** 抽屉用滚珠轴承伸缩滑块抽出，自动关闭
- 所有抽屉均经过精心设计，层搭独一无二
- 由于抽屉止位块，倾斜的风险极小——只能打开一个抽屉，不能同时抽出多个抽屉
- 高品质、耐用的泡沫嵌件，不使用化学气体
- 贴合度优化，可从泡垫中以最佳方式移除工具





9700 Tool Rebel 车间手推车 1



包括以下泡垫



9710

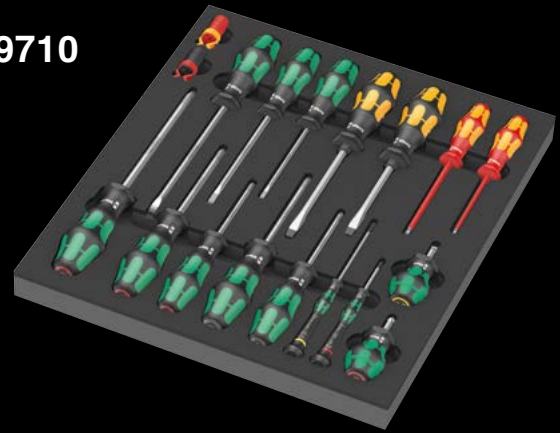

9720

1/4"

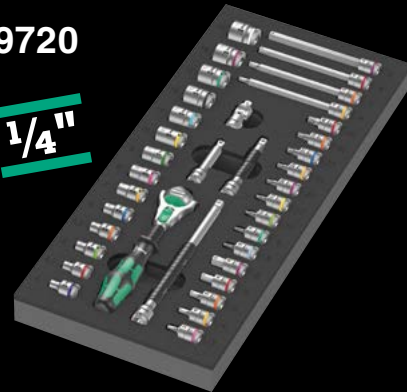

9731



9740



Tool Rebel 设计中的专用车间手推车。五个扁平抽屉和两个高抽屉确保工具和材料的高效移动设计。由于双壁构造和全焊结构，设计极为坚固。适用于车间日常高强度工作。配备四块 Wera 泡垫：9710 泡垫螺丝刀组套 1，9720 泡垫 8000 A Zyklop 棘轮组套 1，9731 泡垫 6003 Joker 环形扳手组套 1，9740 泡垫 L 型扳手组套 1。

05150130001 1x 9700 Tool Rebel 车间手推车 1

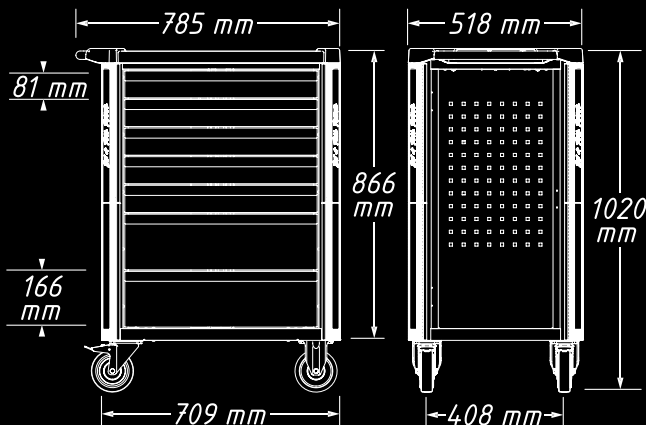

设计坚固以适应车间的高强度工作

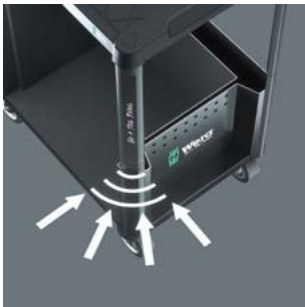

双壁构造和完全焊接的结构使得 "Tool Rebel" 车间手推车极其坚固。在所有四个角落优化的屈服边缘保护, 通过内部缓冲作用, 确保了可靠的冲击保护。

锁紧牢固, 运行顺畅



两台旋转式万向轮配备双挡块: 锁定的万向轮可靠防止了万向轮滚动, 锁定的主轴托架防止万向轮无意中转动, 例如在倾斜的表面。耐油和耐酸弹性轮确保其顺利运行。防护环防止污垢和螺纹进入。

更安全的详细锁定概念



锁具的人体工学排列的横向位置提高了可用性, 保护了钥匙和锁具免受损坏。极其牢固的锁紧系统可以保护储存在车间手推车中的工具免受未经授权的进入。中央锁定由气缸锁定完成。随附两把可折叠的钥匙。

高负荷



车间手推车动载荷540kg, 静载荷1,000kg, 抽屉动载荷25kg。

9710 泡垫螺丝刀组套 1



18 件工具组套 (16 个螺丝刀, 2 个螺丝夹具) 装入 Tool Rebel 车间手推车的双色泡垫内。宽x高x深: 无工具 344 x 30 x 392 mm、有工具 344 x 47 x 392 mm。

05150101001		
⊖	932 A	1x 1,0x5,5x100; 1x 1,2x7,0x125
⊕	350	1x PH 1x80; 1x PH 2x100; 1x PH 3x150
⊕	350 PH Stubby	1x PH 2x25
⊕	355	1x PZ 1x80; 1x PZ 2x100
⊖	335	1x 0,8x4,0x100; 1x 1,0x5,5x125
⊖	334	1x 1,2x6,5x150
⊖	335 Stubby	1x 1,0x5,5x24,5
⊕	2050 Micro	1x PH 0x40 ¹⁾
⊖	2035 Micro	1x 0,40x2,5x80
⊖	160 i VDE	1x 0,4x2,5x80 ²⁾ ; 1x 0,6x3,5x100 ²⁾
	1441	1x 4,5-6,0x41,0
	1442	1x 6,0-8,5x41,0
	9810	1x 344,0x30,0x392,0

¹⁾ 尺寸0根据JIS 0 (日本相机工业标准) 修改

²⁾ 不带Lasertip激光蚀刻刀头

9711 泡垫 VDE 螺丝刀组套 1

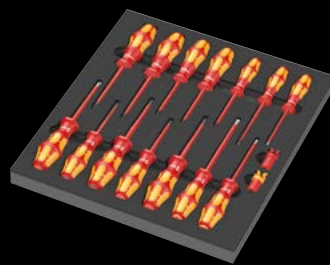

16 件 VDE 绝缘螺丝刀组套 (14 个螺丝刀, 2 个螺丝夹具) 装入 Tool Rebel 车间手推车的双色泡垫内。宽x高x深: 无工具 344 x 30 x 392 mm, 有工具 344 x 46 x 392 mm。

05150102001		
⊕	162 iS PH VDE	1x PH 1x80; 1x PH 2x100
⊕	165 iS PZ VDE	1x PZ 1x80; 1x PZ 2x100
⊕	165 i PZ/S VDE	1x # 2x100
⊖	160 i VDE	1x 0,4x2,5x80 ¹⁾ ; 1x 0,8x4,0x100; 1x 1,0x5,5x125
⊖	160 iS VDE	1x 0,6x3,5x100
⊕	167 i TORX® VDE	1x TX 10x80; 1x TX 15x80; 1x TX 20x80; 1x TX 25x100; 1x TX 30x100
	1440	1x 4,5-6,0x41,0
	1442	1x 6,0-8,5x41,0
	9811	1x 344,0x30,0x392,0

¹⁾ 不带Lasertip激光蚀刻刀头

注意: 泡垫不适用于旧型号 05501051001 的车间手推车。

- 高品质、耐用的泡沫插件，不使用化学气体
- 贴合度优化，可从泡沫垫中以最佳方式移除工具
- 防水拒油，维护成本低，易于清洁
- 保护工具免受污垢和冲击

9720 泡垫 8000 A Zyklop 1/4" 棘轮组套 1

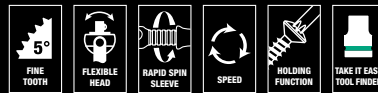

9712 泡垫 TORX® HF 螺丝刀组套 1

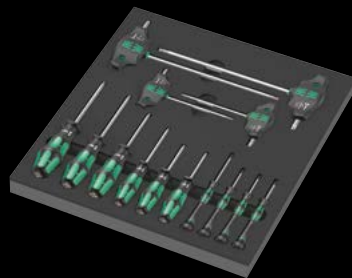

带 TORX® 梅花螺丝固持功能的 14 件螺丝刀组套装入 Tool Rebel 车间手推车的双色泡沫垫内。宽x高x深(无工具): 344 x 30 x 392 mm、有工具 344 x 45 x 392 mm。

37 件 1/4" Zyklop 棘轮组套装入 Tool Rebel 车间手推车的双色泡沫垫内。宽x高x深: 无工具 172 x 30 x 392 mm、有工具 172 x 40 x 392 mm。

05150103001	
⊕	367 TORX® HF 1x TX 8x60; 1x TX 9x60; 1x TX 10x80; 1x TX 15x80; 1x TX 20x100; 1x TX 25x100
⊕	2067 TORX® HF Micro 1x TX 4x40; 1x TX 5x40; 1x TX 6x40; 1x TX 7x60
⊕	467 TORX® HF 1x TX 20x100; 1x TX 25x100; 1x TX 30x200; 1x TX 40x200
9812	1x 344,0x30,0x392,0

05150110001	
⊕	8000 A 1x 1/4"x152,0
⊕	8794 LA 1x 1/4"x150,0
⊕	8794 SA 1x 1/4"x75,0
⊕	8795 A 1x 1/4"x35,5
⊕	8794 A 1x 1/4"x56,0
⊕	8790 HMA 1x 4,0x23,0; 1x 4,5x23,0; 1x 5,0x23,0; 1x 5,5x23,0; 1x 6,0x23,0; 1x 7,0x23,0; 1x 8,0x23,0; 1x 9,0x23,0; 1x 10,0x23,0; 1x 11,0x23,0; 1x 12,0x23,0; 1x 13,0x23,0; 1x 14,0x23,0; 1x 15,0x23,0
⊕	8767 A HF 1x TX 8x28,0; 1x TX 9x28,0; 1x TX 10x28,0; 1x TX 15x28,0; 1x TX 20x28,0; 1x TX 25x28,0; 1x TX 27x28,0; 1x TX 30x28,0; 1x TX 40x28,0
⊕	8740 A HF 1x 3,0x28,0; 1x 4,0x28,0; 1x 4,0x100,0; 1x 5,0x28,0; 1x 5,0x100,0; 1x 6,0x28,0; 1x 6,0x100,0; 1x 8,0x28,0; 1x 8,0x100,0
9820	1x 172,0x30,0x392,0

9713 泡垫六角螺丝刀组套 1

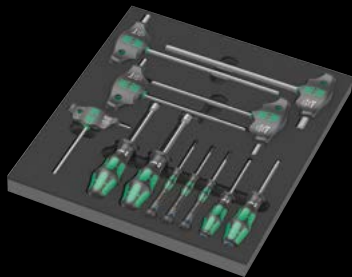

内六角螺丝和外六角螺丝的 12 件螺丝刀组套装入 Tool Rebel 车间手推车的双色泡沫垫内。宽x高x深(无工具): 344 x 30 x 392 mm、有工具 344 x 45 x 392 mm。

9721 泡垫 8000 B Zyklop 3/8" 棘轮组套 1

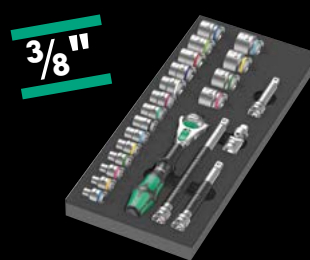

23 件 3/8" Zyklop 棘轮组套装入 Tool Rebel 车间手推车的双色泡沫垫内。宽x高x深: 无工具 172 x 30 x 392 mm、有工具 172 x 45 x 392 mm。

05150104001	
⊕	354 1x 3,0x75; 1x 4,0x75
⊕	2054 Micro 1x 1,5x60; 1x 2x60; 1x 2,5x60
⊕	454 HF 1x 4x100; 1x 5x100; 1x 6x150; 1x 8x200; 1x 10x200
⊕	395 HO 1x 10,0x90; 1x 13,0x90
9813	1x 344,0x30,0x392,0

05150111001	
⊕	8000 B 1x 3/8"x199,0
⊕	8794 SB 1x 3/8"x125,0
⊕	8794 LB 1x 3/8"x200,0
⊕	8795 B 1x 3/8"x50,0
⊕	8794 B 1x 3/8"x76,0
⊕	8790 HMB 1x 6,0x29,0; 1x 7,0x29,0; 1x 8,0x29,0; 1x 9,0x29,0; 1x 10,0x29,0; 1x 11,0x29,0; 1x 12,0x29,0; 1x 13,0x29,0; 1x 14,0x29,0; 1x 15,0x29,0; 1x 16,0x30,0; 1x 17,0x30,0; 1x 18,0x30,0; 1x 19,0x30,0; 1x 20,0x30,0; 1x 21,0x30,0; 1x 22,0x30,0; 1x 24,0x32,0
9821	1x 172,0x30,0x392,0

9722 泡垫 8000 C Zyklop 1/2" 棘轮组套 1

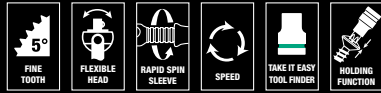

31 件 1/2" Zyklop 棘轮组套装入 Tool Rebel 车间手推车的双色泡垫内。宽x高x深: 无工具 344 x 30 x 392 mm、有工具 344 x 51 x 392 mm。

05150112001		
8000 C	1x 1/2"x277,0	
8794 LC	1x 1/2"x250,0	
8794 SC	1x 1/2"x125,0	
8795 C	1x 1/2"x69,0	
8794 C	1x 1/2"x52,0	
8790 HMC	1x 10,0x37,0; 1x 11,0x37,0; 1x 12,0x37,0; 1x 13,0x37,0; 1x 14,0x37,0; 1x 15,0x37,0; 1x 16,0x37,0; 1x 17,0x37,0; 1x 18,0x37,0; 1x 19,0x37,0; 1x 20,0x37,0; 1x 21,0x37,0; 1x 22,0x37,0; 1x 24,0x37,0; 1x 27,0x40,0; 1x 30,0x42,0; 1x 32,0x42,0	
8740 C HF	1x 4,0x60,0; 1x 4,0x140,0; 1x 5,0x60,0; 1x 5,0x140,0; 1x 6,0x60,0; 1x 6,0x140,0; 1x 7,0x60,0; 1x 8,0x60,0; 1x 10,0x60,0	
9822	1x 344,0x30,0x392,0	

9723 泡垫 Zyklop B 3/8" 批头套筒组套 1



22 件 3/8" Zyklop 批头套筒组套装入 Tool Rebel 车间手推车的双色泡垫内。宽x高x深: 无工具 172 x 30 x 392 mm、有工具 172 x 39 x 392 mm。

05150113001		
8784 B1	1x 1/4"x3/8"x44,0	
8767 B HF	1x TX 15x35,0; 1x TX 20x35,0; 1x TX 25x35,0; 1x TX 25x107,0; 1x TX 27x35,0; 1x TX 27x107,0; 1x TX 30x35,0; 1x TX 30x107,0; 1x TX 40x35,0; 1x TX 40x107,0	
8740 B HF	1x 4,0x35,0; 1x 4,0x107,0; 1x 5,0x35,0; 1x 5,0x107,0; 1x 6,0x35,0; 1x 6,0x107,0; 1x 7,0x38,5; 1x 8,0x38,5; 1x 8,0x100,0; 1x 10,0x38,5; 1x 10,0x100,0	
9823	1x 172,0x30,0x392,0	

安全储存和快速概述

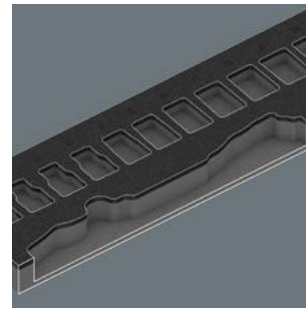

由于精确的等高线切断, 这些工具牢固收放于泡垫中, 但很容易拆除。精心设计的工具布置确保了节省空间的储存和快速进入每种工具。

9730 泡垫 6000 Joker 组套 1



11 件 6000 件 Joker 环形棘轮扳手组套装入 Tool Rebel 车间手推车的双色泡垫内。宽x高x深: 无工具 172 x 30 x 392 mm、有工具 172 x 47 x 392 mm。

05150120001		
6000 Joker	1x 8x144; 1x 10x159; 1x 11x165; 1x 12x170,7; 1x 13x177; 1x 14x188; 1x 15x200; 1x 16x212; 1x 17x224; 1x 18x235; 1x 19x246	
9830	1x 172,0x30,0x392,0	

9731 泡垫 6003 Joker 组套 1

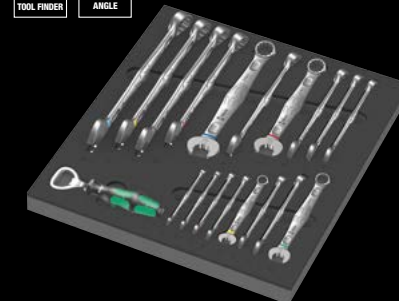
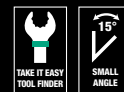

18 件 6003 Joker 环形扳手组套和 1 个 Kraftform 开瓶器装入 Tool Rebel 车间手推车的双色泡垫内。宽x高x深: 无工具 344 x 30 x 392 mm、有工具 344 x 58 x 392 mm。

05150121001		
6003 Joker	1x 6x105; 1x 7x110; 1x 8x115; 1x 9x120; 1x 10x125; 1x 11x135; 1x 12x148; 1x 13x160; 1x 14x167; 1x 15x174; 1x 16x182; 1x 17x190; 1x 18x210; 1x 19x230; 1x 20x230; 1x 21x260; 1x 22x260; 1x 24x280	
开瓶器	1x 145	
9831	1x 344,0x30,0x392,0	

9732 泡垫 6004 Joker 组套 1



5 件 6004 Joker 自调式扳手组套装入 Tool Rebel 车间手推车的双色泡垫内。宽x高x深：无工具 172 x 30 x 392 mm、有工具 172 x 35 x 392 mm。

05150122001	
	6004 Joker XS 1x 7-10 ($1/4''-3/8''$)x117
	6004 Joker S 1x 10-13 ($7/16''-1/2''$)x154
	6004 Joker M 1x 13-16 ($1/2''-5/8''$)x188
	6004 Joker L 1x 16-19 ($5/8''-3/4''$)x224
	6004 Joker XL 1x 19-24 ($3/4''-15/16''$)x256
	9832 1x 172,0x30,0x392,0

9740 泡垫 L 型扳手套组 1

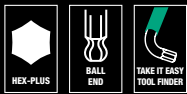

18 件 L 型扳手套组 (内六角螺丝和 TORX® 梅花螺丝) 加上一个 Wera 加磁器和一个 Stabila 袖珍卷尺 (3米) 装入 Tool Rebel 车间手推车的双色泡垫内。宽x高x深：无工具 172 x 30 x 392 mm、有工具 172 x 44 x 392 mm。

05150140001	
	1x 950/9 Hex-Plus Multicolour 1
○	950 SPKL Multicolour 1x 1.5x90; 1x 2.0x101; 1x 2.5x112; 1x 3.0x123; 1x 4.0x137; 1x 5.0x154; 1x 6.0x172; 1x 8.0x195; 1x 10.0x224
	1x 967/9 TX XL Multicolour 1
⊗	967 SXL TORX® Multicolour 1x TX 8x90; 1x TX 9x101; 1x TX 10x112
⊗	967 SPKXL TORX® Multicolour 1x TX 15x123; 1x TX 20x137; 1x TX 25x154; 1x TX 27x172; 1x TX 30x195; 1x TX 40x224
	1x 9500 1x 48.0
	1x STABILA® 袖珍卷尺 BM 100, 3 m, 项目19570 1x 3000,0
	1x 9840 1x 172,0x30,0x392,0

双色泡垫



拆下工具后，浅灰色的第二层泡垫就会显现出来，因此很快就能识别出缺失的工具。

9750 泡垫 Kraftform Kompakt 和 Tool-Check PLUS 组套 1



57 件工具组套 (1 件 Tool-Check PLUS (39 件)、1 件 Kraftform Kompakt 60 (16 件) 和 1 件带软轴的插换式螺丝刀) 装入 Tool Rebel 车间手推车的双色泡垫内。宽x高x深：无工具 172 x 30 x 392 mm、有工具 172 x 59 x 392 mm。

05150150001	
	1x Tool-Check PLUS 组套
○	8001 A 1x 1/4"x87.0
●	813 1x 1/4"x78
⊗	889/4/1 K 1x 1/4"x50
○	870/1 1x 1/4"x25 ¹⁾
●	8790 HMA 1x 5.5x23.0; 1x 6.0x23.0; 1x 7.0x23.0; 1x 8.0x23.0; 1x 10.0x23.0; 1x 12.0x23.0; 1x 13.0x23.0
⊕	851/1 TZ 2x PH 1x25; 3x PH 2x25; 1x PH 3x25
⊕	855/1 TH 1x PZ 1x25; 3x PZ 2x25; 1x PZ 3x25
⊗	867/1 TZ TORX® 1x TX 10x25; 1x TX 15x25; 1x TX 20x25; 1x TX 25x25; 1x TX 30x25; 1x TX 40x25
⊗	867/1 Z TORX® B0 1x TX 10x25; 1x TX 15x25; 1x TX 20x25; 1x TX 25x25; 1x TX 30x25
○	840/1 Z 1x 3.0x25; 1x 4.0x25; 1x 5.0x25; 1x 6.0x25; 1x 8.0x25
●	800/1 TZ 1x 1.0x5.5x25
	1x Kraftform Kompakt 60
●	816 R 1x 1/4"x119
⊕	851/4 Z 1x PH 1x89; 1x PH 2x89; 1x PH 3x89
⊕	855/4 Z 1x PZ 1x89; 1x PZ 2x89; 1x PZ 3x89
⊗	867/4 Z TORX® B0 1x TX 10x89; 1x TX 15x89; 1x TX 20x89; 1x TX 25x89; 1x TX 30x89
●	800/4 Z 1x 1.0x5.5x89
○	840/4 Z 1x 3.0x89; 1x 4.0x89; 1x 5.0x89; 1x 6.0x89
	魔术贴 70 1x 50.0x70.0
	1x 393 S 插换式软轴螺丝刀
●	1x 1/4"x173,5
	1x 9850 1x 172,0x30,0x392,0

9780 泡垫 KNIPEX 钳组套 1



3件钳组套(1件 KNIPEX 组合钳, 镀铬, 1件 KNIPEX Cobra® 高科技水泵钳, 镀铬, 1件 KNIPEX 高杠杆斜切刀, 镀铬) 装入 Tool Rebel 车间手推车的双色泡垫内。宽x高x深: 无工具 172 x 30 x 392 mm、有工具 172 x 38 x 392 mm。

05150180001		
	KNIPEX 钢丝平嘴老虎钳 03 05 180	1x 180
	KNIPEX® Cobra® 高科技水泵钳 87 05 250	1x 250
	KNIPEX 省力斜口钳 74 05 160	1x 160
	9880	1x 172,0x30,0x392,0

9781 泡垫 KNIPEX 钳组套 2

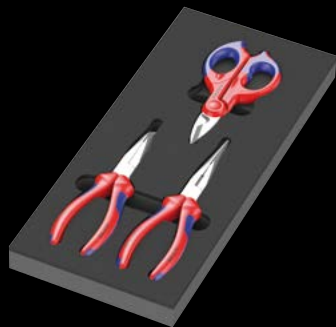

3件钳组套(1件 KNIPEX 鹬嘴侧切割钳(鹬嘴钳), 1件 KNIPEX 机工用钳, 1件 KNIPEX 电工剪切机) 装入 Tool Rebel 车间手推车的双色泡垫内。宽x高x深: 无工具 172 x 30 x 392 mm、有工具 172 x 38 x 392 mm。

05150181001		
	KNIPEX 尖嘴钳 26 15 200	1x 200
	KNIPEX 机工用钳 38 25 200	1x 200
	KNIPEX 不锈钢电工剪 95 05 155	1x 155
	9881	1x 172,0x30,0x392,0

9782 泡垫锤组套 1



6件工具组套(1把 PICARD® 柳钉锤(500克)、4个彩色编码的 RENNSTEIG 销子冲头、1把 RENNSTEIG 扁平冷凿) 装入 Tool Rebel 车间手推车的双色泡垫内。宽x高x深: 无工具 172 x 30 x 392 mm、有工具 172 x 35 x 392 mm。

05150182001		
	PICARD® 柳钉锤500g, 0000101-500	1x 500,0
	○ RENNSTEIG 限量穿孔工具	1x 452 003 6 RC, 3,0x150; 1x 452 004 6 RC, 4,0x150; 1x 452 006 6 RC, 6,0x150; 1x 452 008 6 RC, 8,0x150
	● RENNSTEIG 平头凿 310 250 1 9882	1x 25,0x13,0x23,0 1x 172,0x30,0x392,0

9783 泡垫 PFERD 锉刀组套 1

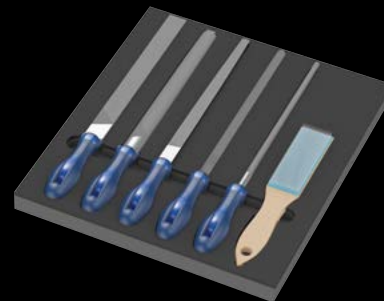

6件锉刀组套(1件 PFERD 方锉 PF1142 250 H2、1件 PFERD 半圆尖头锉 PF 1152SP 250 H2、1件 PFERD 圆锉 PF1162 250 H2、1件 PFERD 手锉 PF1112 250 H2、1件 PFERD 三角锉 PF 1132 250 H2、1件 PFERD 刮刷 HBF ST 0.15) 装入 Tool Rebel 车间手推车的双色泡垫内。宽x高x深: 无工具 344 x 30 x 392 mm、有工具 344 x 42 x 392 mm。

05150183001		
	PFERD 机工用方锉 PF1142 250 H2	1x 250
	PFERD 机工用半圆尖头锉 1152SP 250 H2	1x 250
	PFERD 机工用圆锉 1162 250 H2	1x 250
	PFERD 机工用手锉 1112 250 H2	1x 250
	PFERD 机工用三角锉 1132 250 H2	1x 250
	PFERD 刮刷 HBF 钢丝直径不小于0.15	1x 232
	9883	1x 344,0x30,0x392,0

敝司将保留可对本目录中所记载和产品特点，种类和执行相关的内容进行更新或修改的权利，事前无需预告。敝司无需对任何因为印刷造成的错误和误导负责。

欢迎联络我们

中国经销代理

凯尼派克工具(上海)有限公司

Phone: +86 (0) 21-58998010
Fax: +86 (0) 21-58998050

E-Mail: info@knipex.com.cn
Internet: www.knipex.com.cn

铭洋工业自动化(上海)有限公司

Phone: +86 (0)21 - 66 24 91 22

E-Mail: service@matfron.com

亚洲总部

Wera Tools Japan G.K.

Phone: +81 70 4813 1142

E-Mail: frank.yang@wera.de

