

Takım Dolabı ve Özel Kesim Süngerler

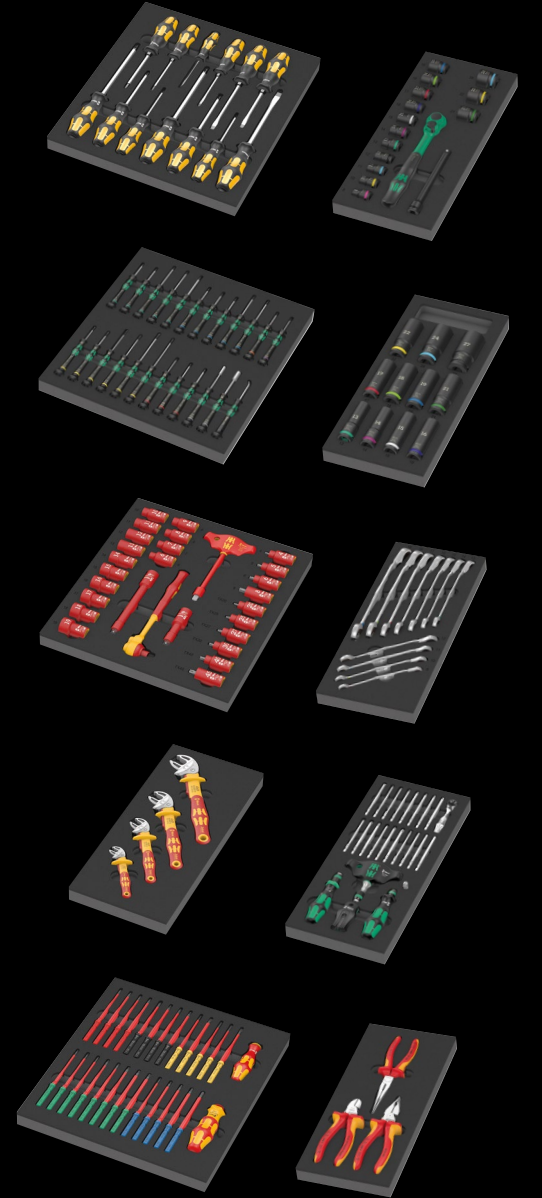

Tool Rebel Takım Dolabı

Üstün kalitede, harika ön tasarıma sahip ve zengin donanımlı takım dolabı.

- Tool Rebel tasarımında özel tekerlekli takım dolabı
- Çift katmanlı yapı sayesinde son derece sağlam tasarım
- 7 çekmeceli (5 düz, 2 yüksek)- bunlardan 2 düz çekmece aletlerle dolu özel kesim sünger ile donatılmıştır
- Düz çekmece boyutları (genişlik x yükseklik x derinlik): 522 x 81 x 398 mm
- Yüksek çekmece boyutları (genişlik x yükseklik x derinlik): 522 x 166 x 398 mm
- % 100 bilye rulmanlı teleskopik kızaklı çekmece, kendiliğinden kapanır
- Özenle ve tek tek yerleştirilmiş çekmeceler
- Çekmece stoperi sayesinde minimum devrilme riski - aynı anda sadece bir çekmece açılabilir, birden fazla çekmecenin aynı anda açılması mümkün değildir
- Kimyasal gaz içermeyen yüksek kaliteli ve dayanıklı özel kesim süngerler
- Aletlerin özel kesim süngerlerden mümkün olan en iyi şekilde çıkarılması için optimum uyum





9700 Tool Rebel Takım Dolabı 1



Tool Rebel tasarımında özel takım dolabı. 5 adet düz ve 2 adet yüksek çekmece, alet ve malzemelerin verimli, mobil şekilde düzenlenmesini sağlar. Çift katmanlı tasarım ve tüm gövdenin tamamen kaynaklı yapısı sayesinde son derece sağlam tasarım. Günlük zorlu atölye kullanımı için uygun. 4 adet Wera özel kesim sünger ile donatılmıştır: 9710 özel kesim süngerli tornavida seti 1, 9720 özel kesim süngerli 8000 A Zyklon cırcır seti 1, 9731 özel kesim süngerli 6003 Joker açık ağız yıldız kombine anahtar seti 1, 9740 özel kesim süngerli allen anahtar seti 1.

05150130001 1x 9700 Tool Rebel Takım Dolabı 1

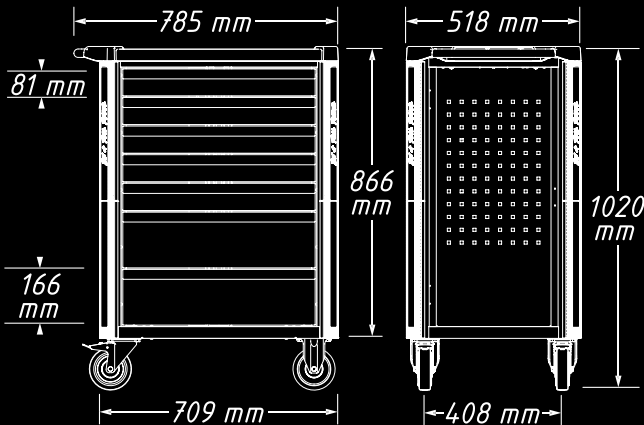

Aşağıdaki özel kesim süngerleri içerir:

9710

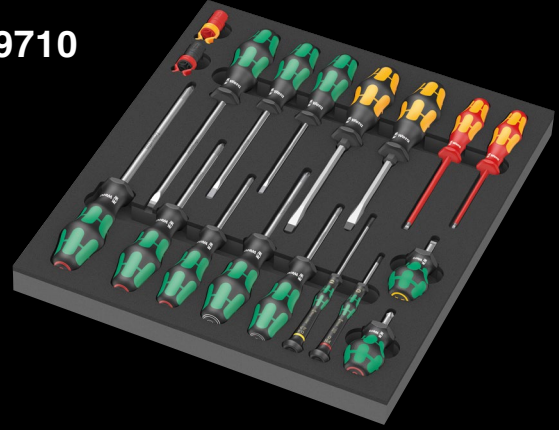

9720

1/4"

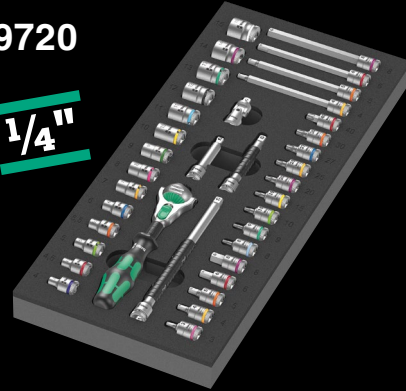

9731



9740



YENI

9714 Özel Kesim Sünger Keski Tornavida Set 1

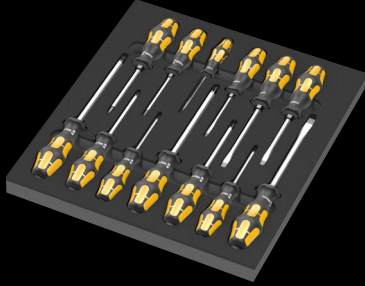

05150105001		
+	917 SPH	1x PH 1x80; 1x PH 2x100; 1x PH 3x150
+	918 SPZ	1x PZ 1x80; 1x PZ 2x100; 1x PZ 3x150
-	932 A	1x 0,6x3,5x80 ¹⁾ ; 1x 0,8x4,5x90; 1x 1,0x5,5x100; 1x 1,2x7,0x125; 1x 1,6x9,0x150
+	977 TORX®	1x TX 20x90; 1x TX 25x100
	9814	1x 344,0x30,0x392,0

¹⁾ Yekpare olmayan bıçak, darbe başlığı yok ve altigen destek yok

YENI

9715 Özel Kesim Sünger Kraftform Micro Tornavida Set 1

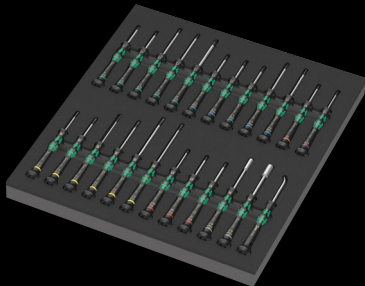

05150106001		
+	2050 Micro	1x PH 000x40 ^{1) 2)} ; 1x PH 00x40 ^{1) 2)} ; 1x PH 0x40 ³⁾
+	2067 TORX® HF	1x TX 5x40; 1x TX 6x40; 1x TX 7x60; 1x TX 8x60; 1x TX 10x60
+	2067 TORX PLUS® IPR Micro	1x 1 IPRx40 ⁴⁾
+	2072 Micro	1x mx40
+	2054 Micro	1x 0,7x40; 1x 0,9x40; 1x 1,3x40; 1x 1,5x60; 1x 2x60
-	2035 Micro	1x 0,23x1,5x40; 1x 0,30x1,8x60; 1x 0,35x2,5x40; 1x 0,40x2,0x60; 1x 0,40x2,5x80; 1x 0,50x3,0x80
+	2069 Micro	1x 4,0x60; 1x 5,5x60
+	1429	1x 1,0x3,5x50
	9815	1x 344,0x30,0x392,0

¹⁾ Japon PH-Yıldız vidaları için optimize edilmiştir

²⁾ Çıkış tarafında, bıçak 10 mm nominal uzunluğa döndürülür

³⁾ Boyut 0, JCIS 0'a (Japon Kamera Endüstriyel Standardı) göre uyarlanmıştır

⁴⁾ Deliksiz

YENI

9726 Özel Kesim Sünger 8007 B VDE Zyklop VDE Cırcır Set 1, 3/8"



05150116001		
+	8007 B VDE	1x 3/8"x222,0
+	410 i VDE B	1x 3/8"x130
+	8790 B VDE	1x 6,0x46,0; 1x 7,0x46,0; 1x 8,0x46,0; 1x 9,0x46,0; 1x 10,0x46,0; 1x 11,0x46,0; 1x 12,0x46,0; 1x 13,0x46,0; 1x 14,0x46,0; 1x 15,0x46,0; 1x 16,0x46,0; 1x 17,0x46,0; 1x 18,0x46,0; 1x 19,0x46,0
+	8767 B VDE HF	1x TX 20x55,0; 1x TX 25x55,0; 1x TX 27x55,0; 1x TX 30x55,0; 1x TX 40x55,0; 1x TX 45x59,0
+	8740 B VDE HF	1x 4,0x55,0; 1x 5,0x55,0; 1x 6,0x55,0; 1x 8,0x59,0
+	8794 SB VDE	1x 3/8"x91,0
+	8794 LB VDE	1x 3/8"x166,0
	9826	1x 344,0x30,0x392,0

YENI

9734 Özel Kesim Sünger 6004 Joker VDE Set 1



05150124001		
	6004 Joker VDE XS	1x 7-10 (1/4"-3/8")x119
	6004 Joker VDE S	1x 10-13 (7/16"-1/2")x155
	6004 Joker VDE M	1x 13-16 (1/2"-5/8")x190
	6004 Joker VDE L	1x 16-19 (5/8"-3/4")x226
	9834	1x 172,0x30,0x392,0

Dikkat: Özel kesim sünger, atölye arabasının önceki modeli olan 05501051001'e uymaz.

YENI

9751 Özel Kesim Sünger Kraftform Kompakt VDE Set 1

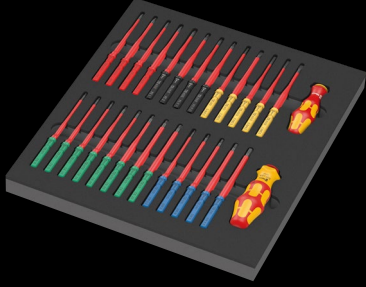

05150151001		
●	837 i RA	1x 9x115
●	817 VDE	1x 9x98
⊕	Kraftform Kompakt VDE 62 iS Take it easy	1x PH 1x157; 1x PH 2x157
⊕	Kraftform Kompakt VDE 65 iS Take it easy	1x PZ 1x157; 1x PZ 2x157
⊕	Kraftform Kompakt VDE 62 iS PH/S Take it easy	1x # 1x157; 1x # 2x157
⊕	Kraftform Kompakt VDE 65 iS PZ/S Take it easy	1x # 1x157; 1x # 2x157
⊕	Kraftform Kompakt VDE 67 i Take it easy	1x TX 8x157; 1x TX 9x157; 1x TX 10x157; 1x TX 27x157; 1x TX 30x157
⊕	Kraftform Kompakt VDE 67 iS Take it easy	1x TX 15x157; 1x TX 20x157; 1x TX 25x157
○	Kraftform Kompakt VDE 64 i Take it easy	1x 2,5x157; 1x 3,0x157; 1x 4,0x157; 1x 5,0x157; 1x 6,0x157
⊖	Kraftform Kompakt VDE 60 iS Take it easy	1x 0,6x3,5x157; 1x 0,8x4,0x157; 1x 1,0x5,5x157
⊖	Kraftform Kompakt VDE 60 i Take it easy	1x 0,4x2,5x157; 1x 1,2x6,5x157
	9851	1x 344,0x30,0x392,0

YENI

9724 Özel Kesim Sünger 8010 B Zyklop Comfort Cırcır Set 1, 3/8"



3/8"



05150114001		
○	8010 B	1x 3/8"x230,0
●	8790 B Impaktör	1x 8,0x30,0; 1x 10,0x30,0; 1x 11,0x30,0; 1x 12,0x30,0; 1x 13,0x30,0; 1x 14,0x30,0; 1x 15,0x30,0; 1x 16,0x30,0; 1x 17,0x30,0; 1x 18,0x30,0; 1x 19,0x30,0; 1x 21,0x32,0; 1x 22,0x32,0; 1x 24,0x32,0
●○	8798 B	1x 3/8"x152,4
	9824	1x 172,0x30,0x392,0

YENI

9725 Özel Kesim Sünger Zyklop C, 1/2", Impaktör Derin Lokma Set 1



05150115001		
●	8790 C Impaktör Deep	1x 13,0x83,0; 1x 14,0x83,0; 1x 15,0x83,0; 1x 16,0x83,0; 1x 17,0x83,0; 1x 18,0x83,0; 1x 19,0x83,0; 1x 21,0x83,0; 1x 22,0x83,0; 1x 24,0x83,0; 1x 27,0x83,0
	9825	1x 172,0x30,0x392,0

YENI

9733 Özel Kesim Sünger 6001 Joker Switch Set 1



05150123001	
6001 Joker Switch	1x 8x144; 1x 10x159; 1x 11x165; 1x 12x171; 1x 13x179; 1x 14x187; 1x 15x199; 1x 16x213; 1x 17x225; 1x 18x234; 1x 19x246
9833	1x 172,0x30,0x392,0

YENI

9784 Özel Kesim Sünger KNIPEX Pense Set VDE 1

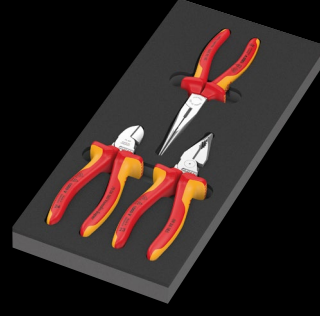

05150184001	
KNIPEX Yan Keski 70 06 160	
KNIPEX Kargaburun (Leylek Burnu Tipi Pense) 26 16 200	
KNIPEX Sivri Uçlu Kombine Pense 08 26 185	
9884	1x 172,0x30,0x392,0

YENI

9752 Özel Kesim Sünger Kraftform Kompakt Cırcırlı Set 1



1/4"



05150152001	
838 RA-R M	1x 1/4"x123,5
416 RA	1x 1/4"x45
816 R	1x 1/4"x119
8001 A	1x 1/4"x87,0
851/4 Z	1x PH 1x89; 1x PH 2x89; 1x PH 3x89 ¹⁾
855/4 Z	1x PZ 1x89; 1x PZ 2x89; 1x PZ 3x89 ¹⁾
867/4 Z TORX®	1x TX 10x89; 1x TX 15x89; 1x TX 20x89; 1x TX 25x89; 1x TX 27x89; 1x TX 30x89; 1x TX 40x89
840/4 Z	1x 3,0x89; 1x 4,0x89; 1x 5,0x89; 1x 6,0x89 ¹⁾
800/4 Z	1x 1,0x5,5x89
870/1	1x 1/4"x25 ²⁾
9500	1x 64,6
9852	1x 172,0x30,0x392,0

¹⁾ Altıgen bıçak

²⁾ Bilyeli; manuel döndürülen lokmalar için

9710 Özel Kesim Süngerli Tornavida Set 1

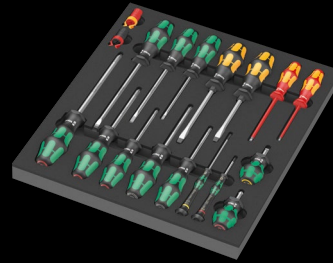

05150101001	
932 A	1x 1,0x5,5x100; 1x 1,2x7,0x125
350 PH	1x PH 1x80; 1x PH 2x100; 1x PH 3x150
350 PH Stubby/Topaç/ Karbüratör Tornavidası	1x PH 2x25
355 PZ	1x PZ 1x80; 1x PZ 2x100
335	1x 0,8x4,0x100; 1x 1,0x5,5x125
334	1x 1,2x6,5x150
335 Stubby/Topaç/ Karbüratör Tornavidası	1x 1,0x5,5x24,5
2050 Micro	1x PH 0x40 ¹⁾
2035 Micro	1x 0,40x2,5x80
160 i VDE	1x 0,4x2,5x80 ²⁾ ; 1x 0,6x3,5x100 ²⁾
1441	1x 4,5-6,0x41,0
1442	1x 6,0-8,5x41,0
9810	1x 344,0x30,0x392,0

¹⁾ Boyut 0, JCIS 0'a (Japon Kamera Endüstriyel Standardı) göre uyarlanmıştır

²⁾ Lasertip' siz.

9711 Özel Kesim Süngerli VDE Tornavida Set 1

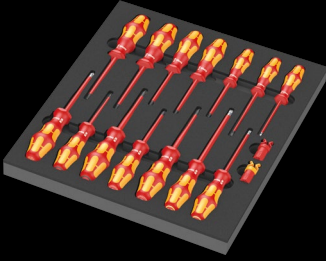

05150102001	
+	162 iS PH VDE 1x PH 1x80; 1x PH 2x100
+	165 iS PZ VDE 1x PZ 1x80; 1x PZ 2x100
+	165 i PZ/S VDE 1x # 2x100
-	160 i VDE 1x 0,4x2,5x80 ¹⁾ ; 1x 0,8x4,0x100; 1x 1,0x5,5x125
-	160 iS VDE 1x 0,6x3,5x100
+	167 i TORX® VDE 1x TX 10x80; 1x TX 15x80; 1x TX 20x80; 1x TX 25x100; 1x TX 30x100
	1440 1x 4,5-6,0x41,0
	1442 1x 6,0-8,5x41,0
	9811 1x 344,0x30,0x392,0

¹⁾ Lasertip'siz.

9713 Özel Kesim Süngerli Altıgen Tornavida Set 1

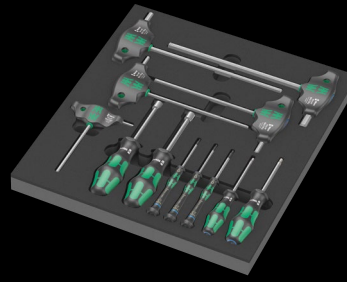

05150104001	
○	354 1x 3,0x75; 1x 4,0x75
○	2054 Micro 1x 1,5x60; 1x 2x60; 1x 2,5x60
○	454 HF 1x 4x100; 1x 5x100; 1x 6x150; 1x 8x200; 1x 10x200
●	395 H0 1x 10,0x90; 1x 13,0x90
	9813 1x 344,0x30,0x392,0

9720 Özel Kesim Süngerli 8000 A Zyklop Circir 1/4" Set 1



9712 Özel Kesim Süngerli TORX® HF Tornavida Set 1

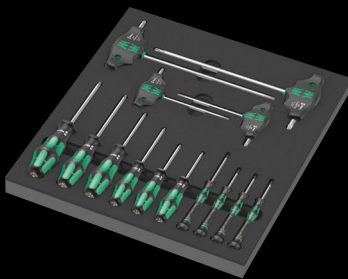

05150103001	
+	367 TORX® HF 1x TX 8x60; 1x TX 9x60; 1x TX 10x80; 1x TX 15x80; 1x TX 20x100; 1x TX 25x100
+	2067 TORX® HF 1x TX 4x40; 1x TX 5x40; 1x TX 6x40; 1x TX 7x60
+	467 TORX® HF 1x TX 20x100; 1x TX 25x100; 1x TX 30x200; 1x TX 40x200
	9812 1x 344,0x30,0x392,0

05150110001	
○	8000 A 1x 1/4"x152,0
●○	8794 LA 1x 1/4"x150,0
●○	8794 SA 1x 1/4"x75,0
●○	8795 A 1x 1/4"x35,5
●○	8794 A 1x 1/4"x56,0
●	8790 HMA 1x 4,0x23,0; 1x 4,5x23,0; 1x 5,0x23,0; 1x 5,5x23,0; 1x 6,0x23,0; 1x 7,0x23,0; 1x 8,0x23,0; 1x 9,0x23,0; 1x 10,0x23,0; 1x 11,0x23,0; 1x 12,0x23,0; 1x 13,0x23,0; 1x 14,0x23,0; 1x 15,0x23,0
+	8767 A HF 1x TX 8x28,0; 1x TX 9x28,0; 1x TX 10x28,0; 1x TX 15x28,0; 1x TX 20x28,0; 1x TX 25x28,0; 1x TX 27x28,0; 1x TX 30x28,0; 1x TX 40x28,0
○	8740 A HF 1x 3,0x28,0; 1x 4,0x28,0; 1x 4,0x100,0; 1x 5,0x28,0; 1x 5,0x100,0; 1x 6,0x28,0; 1x 6,0x100,0; 1x 8,0x28,0; 1x 8,0x100,0
	9820 1x 172,0x30,0x392,0

9721 Özel Kesim Süngerli 8000 B Zyklop Cırcır 3/8" Set 1



3/8"

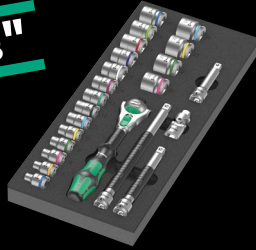

05150111001		
○	8000 B	1x 3/8"x199,0
●○	8794 SB	1x 3/8"x125,0
●○	8794 LB	1x 3/8"x200,0
●○	8795 B	1x 3/8"x50,0
●○	8794 B	1x 3/8"x76,0
●	8790 HMB	1x 6,0x29,0; 1x 7,0x29,0; 1x 8,0x29,0; 1x 9,0x29,0; 1x 10,0x29,0; 1x 11,0x29,0; 1x 12,0x29,0; 1x 13,0x29,0; 1x 14,0x29,0; 1x 15,0x29,0; 1x 16,0x30,0; 1x 17,0x30,0; 1x 18,0x30,0; 1x 19,0x30,0; 1x 20,0x30,0; 1x 21,0x30,0; 1x 22,0x30,0; 1x 24,0x32,0
	9821	1x 172,0x30,0x392,0

9723 Özel Kesim Süngerli Zyklop B 3/8" Lokma Bits Set 1



3/8"



05150113001		
●●	8784 B1	1x 1/4"x3/8"x44,0
⊗	8767 B HF	1x TX 15x35,0; 1x TX 20x35,0; 1x TX 25x35,0; 1x TX 25x107,0; 1x TX 27x35,0; 1x TX 27x107,0; 1x TX 30x35,0; 1x TX 30x107,0; 1x TX 40x35,0; 1x TX 40x107,0
○	8740 B HF	1x 4,0x35,0; 1x 4,0x107,0; 1x 5,0x35,0; 1x 5,0x107,0; 1x 6,0x35,0; 1x 6,0x107,0; 1x 7,0x38,5; 1x 8,0x38,5; 1x 8,0x100,0; 1x 10,0x38,5; 1x 10,0x100,0
	9823	1x 172,0x30,0x392,0

9722 Özel Kesim Süngerli 8000 C Zyklop 1/2" Cırcır Set 1



1/2"



05150112001		
○	8000 C	1x 1/2"x277,0
●○	8794 LC	1x 1/2"x250,0
●○	8794 SC	1x 1/2"x125,0
●○	8795 C	1x 1/2"x69,0
●○	8794 C	1x 1/2"x52,0
●	8790 HMC	1x 10,0x37,0; 1x 11,0x37,0; 1x 12,0x37,0; 1x 13,0x37,0; 1x 14,0x37,0; 1x 15,0x37,0; 1x 16,0x37,0; 1x 17,0x37,0; 1x 18,0x37,0; 1x 19,0x37,0; 1x 20,0x37,0; 1x 21,0x37,0; 1x 22,0x37,0; 1x 24,0x37,0; 1x 27,0x40,0; 1x 30,0x42,0; 1x 32,0x42,0
○	8740 C HF	1x 4,0x60,0; 1x 4,0x140,0; 1x 5,0x60,0; 1x 5,0x140,0; 1x 6,0x60,0; 1x 6,0x140,0; 1x 7,0x60,0; 1x 8,0x60,0; 1x 10,0x60,0
	9822	1x 344,0x30,0x392,0

9730 Özel Kesim Süngerli 6000 Joker Set 1



05150120001		
	6000 Joker	1x 8x144; 1x 10x159; 1x 11x165; 1x 12x170,7; 1x 13x177; 1x 14x188; 1x 15x200; 1x 16x212; 1x 17x224; 1x 18x235; 1x 19x246
	9830	1x 172,0x30,0x392,0

9731 Özel Kesim Süngerli 6003 Joker Set 1



05150121001		
	6003 Joker	1x 6x105; 1x 7x110; 1x 8x115; 1x 9x120; 1x 10x125; 1x 11x135; 1x 12x148; 1x 13x160; 1x 14x167; 1x 15x174; 1x 16x182; 1x 17x190; 1x 18x210; 1x 19x230,0; 1x 20x230,0; 1x 21x260; 1x 22x260; 1x 24x280
	Şişe Açacağı	1x 148
	9831	1x 344,0x30,0x392,0

9732 Özel Kesim Süngerli 6004 Joker Set 1



05150122001		
	6004 Joker XS	1x 7-10 (1/4"-3/8")x117
	6004 Joker S	1x 10-13 (7/16"-1/2")x154
	6004 Joker M	1x 13-16 (1/2"-5/8")x188
	6004 Joker L	1x 16-19 (5/8"-3/4")x224
	6004 Joker XL	1x 19-24x (3/4"-15/16")x256
	9832	1x 172,0x30,0x392,0

9740 Özel Kesim Süngerli Allen Anahtar Set 1



9750 Özel Kesim Süngerli Kraftform Kompakt ve Tool-Check PLUS Set 1



05150150001		
	1x Tool-Check PLUS	
	● 8001 A	1x 1/4"x87,0
	● 813	1x 1/4"x78
	● 889/4/1 K	1x 1/4"x50
	○ 870/1	1x 1/4"x25 ¹⁾
	● 8790 HMA	1x 5.5x23.0; 1x 6.0x23.0; 1x 7.0x23.0; 1x 8.0x23.0; 1x 10.0x23.0; 1x 12.0x23.0; 1x 13.0x23.0
	⊕ 851/1 TZ	2x PH 1x25; 3x PH 2x25; 1x PH 3x25
	⊕ 855/1 TH	1x PZ 1x25; 3x PZ 2x25; 1x PZ 3x25
	⊕ 867/1 TZ TORX®	1x TX 10x25; 1x TX 15x25; 1x TX 20x25; 1x TX 25x25; 1x TX 30x25; 1x TX 40x25
	⊕ 867/1 Z TORX® BO	1x TX 10x25; 1x TX 15x25; 1x TX 20x25; 1x TX 25x25; 1x TX 30x25
	○ 840/1 Z	1x 3.0x25; 1x 4.0x25; 1x 5.0x25; 1x 6.0x25; 1x 8.0x25
	⊖ 800/1 TZ	1x 1.0x5.5x25
	1x Kraftform Kompakt 60	
	● 816 R	1x 1/4"x119
	⊕ 851/4 Z	1x PH 1x89; 1x PH 2x89; 1x PH 3x89 ²⁾
	⊕ 855/4 Z	1x PZ 1x89; 1x PZ 2x89; 1x PZ 3x89 ²⁾
	⊕ 867/4 Z TORX® BO	1x TX 10x89; 1x TX 15x89; 1x TX 20x89; 1x TX 25x89; 1x TX 30x89
	⊖ 800/4 Z	1x 1.0x5.5x89
	○ 840/4 Z	1x 3.0x89; 1x 4.0x89; 1x 5.0x89; 1x 6.0x89 ²⁾
	Cırtcirtlı Bant 70	1x 50.0x70.0
	1x 393 S	
	●	1x 1/4"x173,5
	1x 9850	
		1x 172,0x30,0x392,0

¹⁾ Bilyeli; manuel döndürülen lokmalar için

²⁾ Altıgen bıçak

9780 Özel Kesim Süngerli KNIPEX Pense Set 1



05150180001	
	KNIPEX Kom- bine Pense 03 05 180 1x 180
	KNIPEX Cobra® High-Tech Fort Pense 87 05 250 1x 250
	KNIPEX Ağır Hizmet Yan Keski 74 05 160 1x 160
	9880 1x 172,0x30,0x392,0

9782 Özel Kesim Süngerli Çekiç Set 1

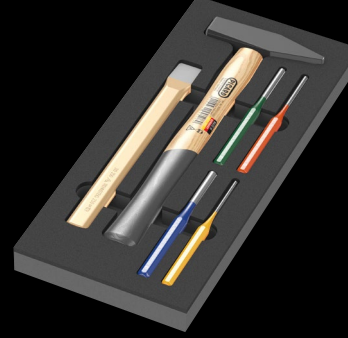

05150182001	
	PICARD® Tesisatçı Çekici 500 G, 0000101 500 1x 500,0
	RENNSTEIG Özel Pim Çıkarıcı 452 003 6 1x 452 003 6 RC, 3,0x150; 1x4520046RC, 4,0x150; 1x4520066RC, 6,0x150; 1x 452 008 6 RC, 8,0x150
	RENNSTEIG Düz Keski 310 250 1 1x 25,0x13,0x23,0
	9882 1x 172,0x30,0x392,0

9781 Özel Kesim Süngerli KNIPEX Pense Set 2

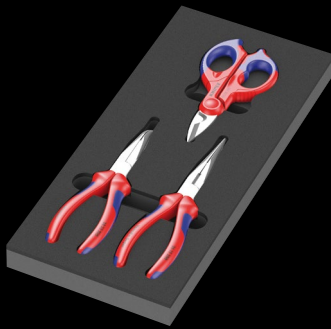

05150181001	
	KNIPEX Karga- burun (Leylek Burnu Tipi Pense) 26 15 200 1x 200
	KNIPEX Meka- niker Pensesi 38 25 200 1x 200
	KNIPEX Elek- trikçi Makası 95 05 155 1x 155
	9881 1x 172,0x30,0x392,0

9783 Özel Kesim Süngerli PFERD Set 1

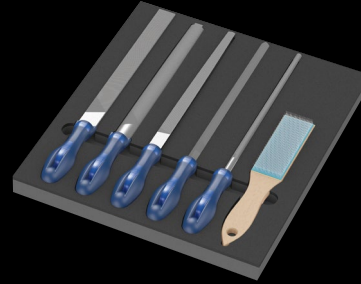

05150183001	
	PFERD Dört Köşe Eşe Pf1142 250 H2 1x 250
	PFERD Yarım Yuvarlak Sivri Uçlu Tesviyeci Eğesi 1152Sp 250 H2 1x 250
	PFERD Yuvar- lak Eşe 1162 250 H2 1x 250
	PFERD Tes- viyeci Eğesi Lama 1112 250 H2 1x 250
	PFERD Üç Köşe Eşe 1132 250 H2 1x 250
	PFERD Eşe Fırça HBF Çelik Tel Ø 0,15 1x 232
	9883 1x 344,0x30,0x392,0



Wera Werkzeuge GmbH
Korzertter StraÙe 21-25
D-42349 Wuppertal

Phone: +49 (0)202/4045-0
E-Mail: info@wera.de
www.wera.de

Surkon Makina Sanayi ve Ticaret Ltd Sti.
Ivedik OSB, Özpetek Sanayi Sitesi 1390 Sokak No: 12
06378 Yenimahalle Ankara – Türkiye

Tel.: +90 312 386 14 64
Email: info@surkon.com
www.surkon.com.tr

Tamer Kabalcioğlu Almeta Co. Ltd.
4.Organize Sanayi Bölgesi 14 Nolu Bulvar No:21
27120 Gaziantep – Türkiye

Tel.: +90 034235703 55
Email: wera@almeta.com.tr
www.almeta.com.tr

Burla Makina Tic. ve Yat. A.Ş.
Bankalar Caddesi No:23
34420 Karaköy / İstanbul – Türkiye

Tel.: 090 (0)212 256 49 50
Email: info@burla.com
www.burla.com

Baskı hataları veya kusurları herhangi
bir yükümlülük doğurmaz ve bunlardan
kaynaklı hiçbir sorumluluk kabul edilmez.