

Werkplaatswagen en schuimrubberen inzetstukken

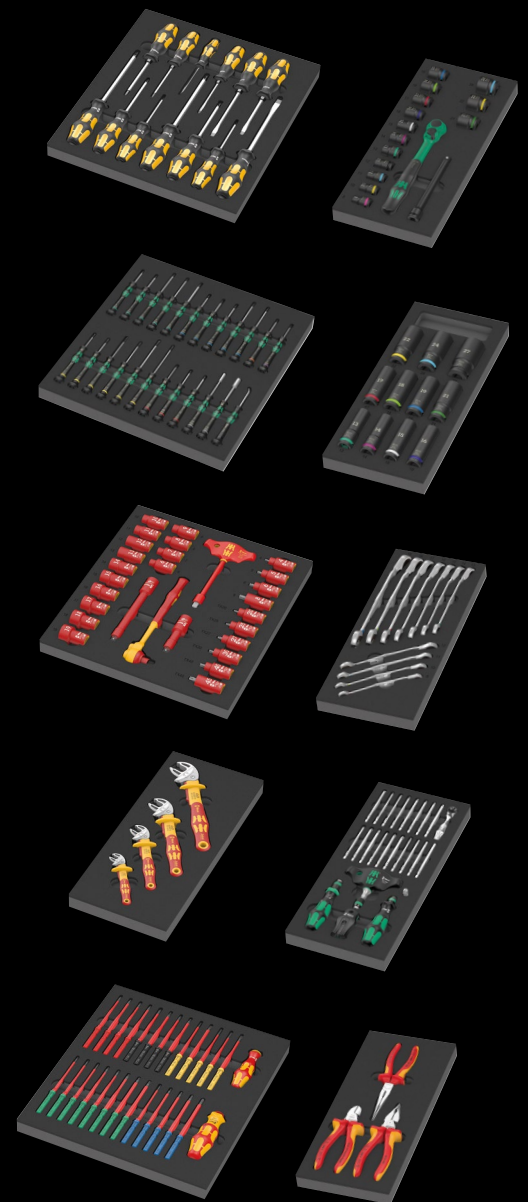

Compleet uitgeruste werkplaatswagen in geniaal front-design en uitgevoerd in absolute topkwaliteit.

- Exclusieve werkplaatswagen met Tool Rebel Design
- Extreem robuuste uitvoering dankzij dubbelwandige constructie
- Met 7 lades (5 laag, 2 hoog) – waarvan 2 lage lades met schuimrubberen inzetstuk en gevuld met gereedschap
- Afmetingen lage lade (breedte x hoogte x diepte): 522 x 81 x 398 mm
- Afmetingen van hoge lades (breedte x hoogte x diepte): 522 x 166 x 398 mm
- De lades kunnen 100 % opengeschoven worden met kogelgelagerde telescopische soft-close rails
- Alle lades zijn elk ruim van folie voorzien
- Minimaal kantelrisico door uittrekblokkering – er kan slechts één lade geopend worden en niet meerdere lades tegelijk
- Hoogwaardige, duurzame schuimrubberen inzetstukken die geen chemische dampen afgeven
- Optimale pasvorm zorgt ervoor dat het gereedschap makkelijk uit de schuimrubberen inzetstukken kan worden verwijderd





9700 Tool Rebel werkplaatswagen 1



Inclusief de volgende schuimrubberen inzetstukken:

9710

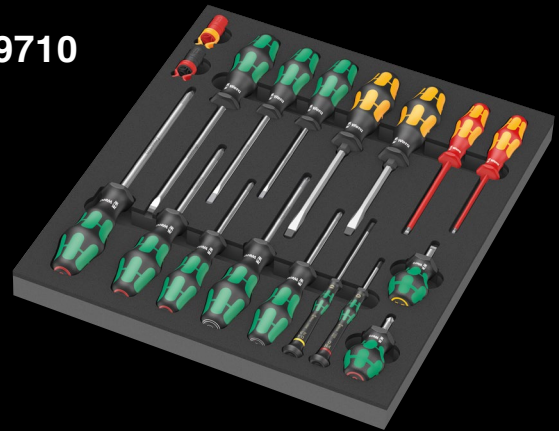

9720

1/4"

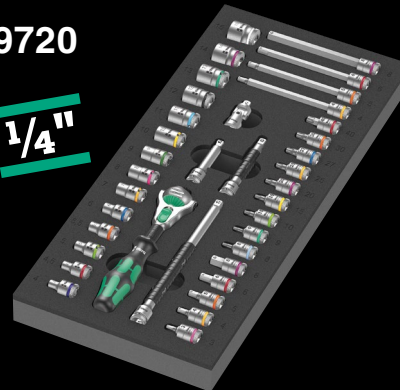

9731



9740



Exclusieve werkplaatswagen - wagen in Tool Rebel Design. 5 lage en 2 hoge lades waarin kunnen gereedschappen en materialen efficiënt opgeborgen kunnen worden voor mobiel gebruik. Extreem robuuste uitvoering met dubbele wanden en een volledig gelaste constructie van de kast. Voor dagelijks zwaar gebruik in de werkplaats. Compleet uitgerust met 4 Wera schuimrubberen inzetstukken: 9710 schuimrubberen inzetstuk voor schroevendraaiers Set 1, 9720 schuimrubberen inzetstuk voor 8000 A Zyklop ratels Set 1, 9731 Schuimrubberen inzetstuk voor 6003 Joker ringsteeksleutels Set 1, 9740 Schuimrubberen inzetstuk voor stiftsleutels Set 1.

05150130001 1x 9700 Tool Rebel werkplaatswagen 1

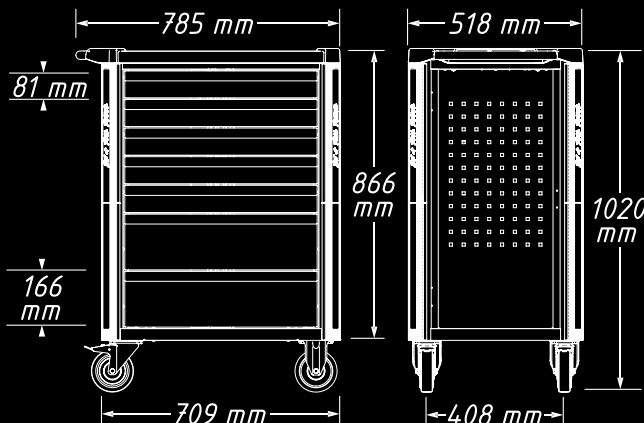

NIEUW

9714 Schuimrubberen inzetstuk De schroefbeitel/ schroevendraaierset 1

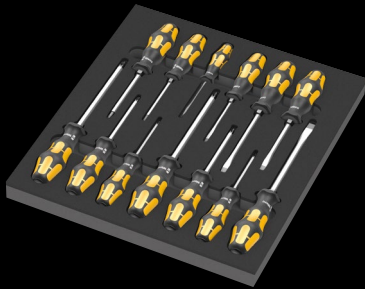

05150105001		
+	917 SPH	1x PH 1x80; 1x PH 2x100; 1x PH 3x150
+	918 SPZ	1x PZ 1x80; 1x PZ 2x100; 1x PZ 3x150
⊖	932 A	1x 0,6x3,5x80 ¹⁾ ; 1x 0,8x4,5x90; 1x 1,0x5,5x100; 1x 1,2x7,0x125; 1x 1,6x9,0x150
⊕	977 TORX®	1x TX 20x90; 1x TX 25x100
	9814	1x 344,0x30,0x392,0

¹⁾ Geen doorlopend kling, slagkop en sleutelhulp

NIEUW

9715 Schuimrubberen inzetstuk schroevendraaiers Kraftform Micro Set 1

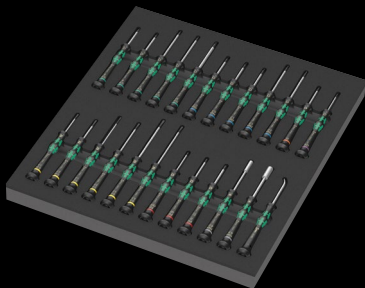

05150106001		
+	2050 Micro	1x PH 000x40 ^{1) 2)} ; 1x PH 00x40 ^{1) 2)} ; 1x PH 0x40 ³⁾
⊕	2067 TORX® HF	1x TX 5x40; 1x TX 6x40; 1x TX 7x60; 1x TX 8x60; 1x TX 10x60
⊕	2067 TORX PLUS® IPR Micro	1x 1 IPRx40 ⁴⁾
⊕	2072 Micro	1x mx40
○	2054 Micro	1x 0,7x40; 1x 0,9x40; 1x 1,3x40; 1x 1,5x60; 1x 2x60
⊖	2035 Micro	1x 0,23x1,5x40; 1x 0,30x1,8x60; 1x 0,35x2,5x40; 1x 0,40x2,0x60; 1x 0,40x2,5x80; 1x 0,50x3,0x80
●	2069 Micro	1x 4,0x60; 1x 5,5x60
●	1429	1x 1,0x3,5x50
	9815	1x 344,0x30,0x392,0

¹⁾ Geoptimaliseerd voor Aziatische PH schroeven

²⁾ Kling aan aandrijfszijde over 10 mm afgedraaid naar gewenste maat

³⁾ Formaat 0 komt overeen met JCIS 0 (Japanese Camera Industrial Standard) gemodificeerd

⁴⁾ Zonder boring

NIEUW

9726 Schuimrubberen inzetstuk 8007 B Zyklop VDE ratelset 1, 3/8"



05150116001		
○	8007 B VDE	1x 3/8"x222,0
○	410 i VDE B	1x 3/8"x130
●	8790 B VDE	1x 6,0x46,0; 1x 7,0x46,0; 1x 8,0x46,0; 1x 9,0x46,0; 1x 10,0x46,0; 1x 11,0x46,0; 1x 12,0x46,0; 1x 13,0x46,0; 1x 14,0x46,0; 1x 15,0x46,0; 1x 16,0x46,0; 1x 17,0x46,0; 1x 18,0x46,0; 1x 19,0x46,0
⊕	8767 B VDE HF	1x TX 20x55,0; 1x TX 25x55,0; 1x TX 27x55,0; 1x TX 30x55,0; 1x TX 40x55,0; 1x TX 45x59,0
○	8740 B VDE HF	1x 4,0x55,0; 1x 5,0x55,0; 1x 6,0x55,0; 1x 8,0x59,0
●	8794 SB VDE	1x 3/8"x91,0
●	8794 LB VDE	1x 3/8"x166,0
	9826	1x 344,0x30,0x392,0

NIEUW

9734 Schuimrubberen inzetstuk 6004 Joker VDE Set 1



05150124001		
	6004 Joker VDE XS	1x 7-10 (1/4"-3/8")x119
	6004 Joker VDE S	1x 10-13 (7/16"-1/2")x155
	6004 Joker VDE M	1x 13-16 (1/2"-5/8")x190
	6004 Joker VDE L	1x 16-19 (5/8"-3/4")x226
	9834	1x 172,0x30,0x392,0

Let op: De schuimrubberen inzetstukken passen niet in het vorige model werkplaatswagen (artikelnummer 05501051001).

NIEUW

9751 Schuimrubberen inzetstuk Kraftform Kompakt VDE Set 1

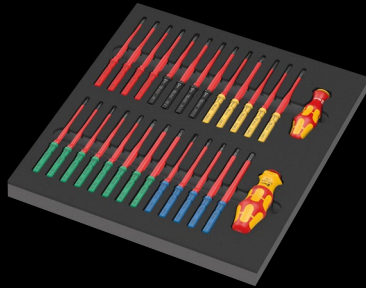

05150151001		
●	837 i RA	1x 9x115
●	817 VDE	1x 9x98
⊕	Kraftform Kompakt VDE 62 iS Take it easy	1x PH 1x157; 1x PH 2x157
⊕	Kraftform Kompakt VDE 65 iS Take it easy	1x PZ 1x157; 1x PZ 2x157
⊕	Kraftform Kompakt VDE 62 iS PH/S Take it easy	1x # 1x157; 1x # 2x157
⊕	Kraftform Kompakt VDE 65 iS PZ/S Take it easy	1x # 1x157; 1x # 2x157
⊕	Kraftform Kompakt VDE 67 i Take it easy	1x TX 8x157; 1x TX 9x157; 1x TX 10x157; 1x TX 27x157; 1x TX 30x157
⊕	Kraftform Kompakt VDE 67 iS Take it easy	1x TX 15x157; 1x TX 20x157; 1x TX 25x157
○	Kraftform Kompakt VDE 64 i Take it easy	1x 2,5x157; 1x 3,0x157; 1x 4,0x157; 1x 5,0x157; 1x 6,0x157
⊖	Kraftform Kompakt VDE 60 iS Take it easy	1x 0,6x3,5x157; 1x 0,8x4,0x157; 1x 1,0x5,5x157
⊖	Kraftform Kompakt VDE 60 i Take it easy	1x 0,4x2,5x157; 1x 1,2x6,5x157
	9851	1x 344,0x30,0x392,0

NIEUW

9724 Schuimrubberen inzetstuk 8010 B Zyklop Comfort ratelset 1, 3/8"



3/8"



05150114001		
○	8010 B	1x 3/8"x230,0
●	8790 B Impaktor	1x 8,0x30,0; 1x 10,0x30,0; 1x 11,0x30,0; 1x 12,0x30,0; 1x 13,0x30,0; 1x 14,0x30,0; 1x 15,0x30,0; 1x 16,0x30,0; 1x 17,0x30,0; 1x 18,0x30,0; 1x 19,0x30,0; 1x 21,0x32,0; 1x 22,0x32,0; 1x 24,0x32,0
●○	8798 B	1x 3/8"x152,4
	9824	1x 172,0x30,0x392,0

NIEUW

9725 Schuimrubberen inzetstuk Zyklop C, 1/2", Impaktor Deep doppen Set 1



05150115001		
●	8790 C Impaktor Deep	1x 13,0x83,0; 1x 14,0x83,0; 1x 15,0x83,0; 1x 16,0x83,0; 1x 17,0x83,0; 1x 18,0x83,0; 1x 19,0x83,0; 1x 21,0x83,0; 1x 22,0x83,0; 1x 24,0x83,0; 1x 27,0x83,0
	9825	1x 172,0x30,0x392,0

NIEUW

9733 Schuimrubberen inzetstuk 6001 Joker Switch Set 1

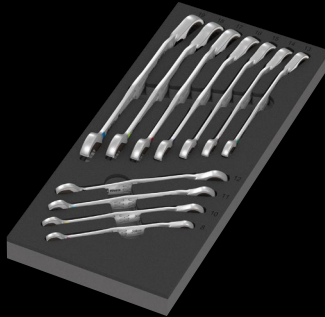

05150123001	
6001 Joker Switch	1x 8x144; 1x 10x159; 1x 11x165; 1x 12x171; 1x 13x179; 1x 14x187; 1x 15x199; 1x 16x213; 1x 17x225; 1x 18x234; 1x 19x246
9833	1x 172,0x30,0x392,0

NIEUW

9784 Schuimrubberen inzetstuk KNIPEX tangen Set VDE 1



05150184001	
KNIPEX zijsnijtang 70 06 160	
KNIPEX puntbektang met snijvlak (puntbektang) 26 16 200	
KNIPEX spitscombinatietang 08 26 185	
9884	1x 172,0x30,0x392,0

NIEUW

9752 Schuimrubberen inzetstuk Krafform Kompakt ratelset 1



1/4"

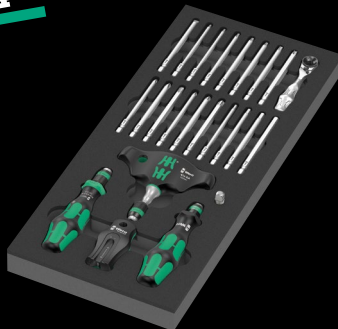

05150152001	
838 RA-R M	1x 1/4"x123,5
416 RA	1x 1/4"x45
816 R	1x 1/4"x119
8001 A	1x 1/4"x87,0
851/4 Z	1x PH 1x89; 1x PH 2x89; 1x PH 3x89 ¹⁾
855/4 Z	1x PZ 1x89; 1x PZ 2x89; 1x PZ 3x89 ¹⁾
867/4 Z TORX®	1x TX 10x89; 1x TX 15x89; 1x TX 20x89; 1x TX 25x89; 1x TX 27x89; 1x TX 30x89; 1x TX 40x89
840/4 Z	1x 3,0x89; 1x 4,0x89; 1x 5,0x89; 1x 6,0x89 ¹⁾
800/4 Z	1x 1,0x5,5x89
870/1	1x 1/4"x25 ²⁾
9500	1x 64,6
9852	1x 172,0x30,0x392,0

¹⁾ Zeskantkling

²⁾ Met kogel; voor handbediende steeksleutelinzetstukken

9710 Schuimrubberen inzetstuk met schroevendraaiers Set 1



05150101001	
932 A	1x 1,0x5,5x100; 1x 1,2x7,0x125
350 PH	1x PH 1x80; 1x PH 2x100; 1x PH 3x150
350 PH Stubby	1x PH 2x25
355 PZ	1x PZ 1x80; 1x PZ 2x100
335	1x 0,8x4,0x100; 1x 1,0x5,5x125
334	1x 1,2x6,5x150
335 Stubby/ carburateur-schroevendraaier	1x 1,0x5,5x24,5
2050 Micro	1x PH 0x40 ¹⁾
2035 Micro	1x 0,40x2,5x80
160 i VDE	1x 0,4x2,5x80 ²⁾ ; 1x 0,6x3,5x100 ²⁾
1441	1x 4,5-6,0x41,0
1442	1x 6,0-8,5x41,0
9810	1x 344,0x30,0x392,0

¹⁾ Formaat 0 komt overeen met JCS 0 (Japanese Camera Industrial Standard) gemodificeerd

²⁾ geen Lasertip punt

9711 Schuimrubberen inzetstuk met VDE schroevendraaiers Set 1

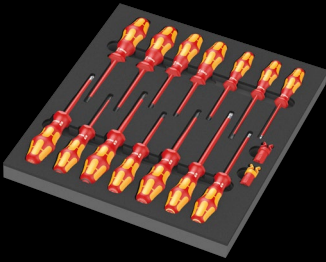

05150102001	
+	162 iS PH VDE 1x PH 1x80; 1x PH 2x100
+	165 iS PZ VDE 1x PZ 1x80; 1x PZ 2x100
+	165 i PZ/S VDE 1x # 2x100
-	160 i VDE 1x 0,4x2,5x80 ¹⁾ ; 1x 0,8x4,0x100; 1x 1,0x5,5x125
-	160 iS VDE 1x 0,6x3,5x100
+	167 i TORX® VDE 1x TX 10x80; 1x TX 15x80; 1x TX 20x80; 1x TX 25x100; 1x TX 30x100
	1440 1x 4,5-6,0x41,0
	1442 1x 6,0-8,5x41,0
	9811 1x 344,0x30,0x392,0

¹⁾ geen Lasertip punt

9713 Schuimrubberen inzetstuk met Hex schroevendraaiers Set 1

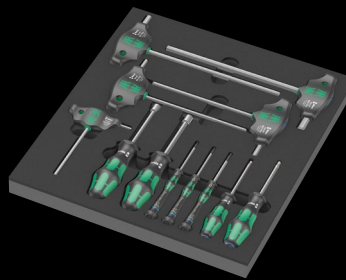

05150104001	
○	354 1x 3,0x75; 1x 4,0x75
○	2054 Micro 1x 1,5x60; 1x 2x60; 1x 2,5x60
○	454 HF 1x 4x100; 1x 5x100; 1x 6x150; 1x 8x200; 1x 10x200
●	395 H0 1x 10,0x90; 1x 13,0x90
	9813 1x 344,0x30,0x392,0

9720 Schuimrubberen inzetstuk met 8000 A Zyklop ratel 1/4" Set 1



9712 Schuimrubberen inzetstuk met TORX® HF-schroevendraaiers Set 1

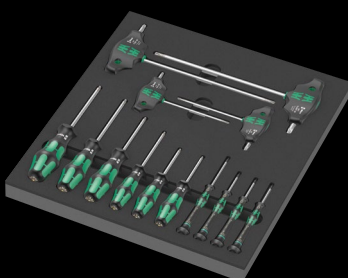
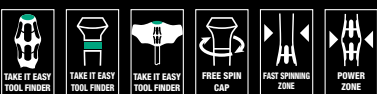

05150103001	
+	367 TORX® HF 1x TX 8x60; 1x TX 9x60; 1x TX 10x80; 1x TX 15x80; 1x TX 20x100; 1x TX 25x100
+	2067 TORX® HF 1x TX 4x40; 1x TX 5x40; 1x TX 6x40; 1x TX 7x60
+	467 TORX® HF 1x TX 20x100; 1x TX 25x100; 1x TX 30x200; 1x TX 40x200
	9812 1x 344,0x30,0x392,0

05150110001	
○	8000 A 1x 1/4"x152,0
●○	8794 LA 1x 1/4"x150,0
●○	8794 SA 1x 1/4"x75,0
●○	8795 A 1x 1/4"x35,5
●○	8794 A 1x 1/4"x56,0
●	8790 HMA 1x 4,0x23,0; 1x 4,5x23,0; 1x 5,0x23,0; 1x 5,5x23,0; 1x 6,0x23,0; 1x 7,0x23,0; 1x 8,0x23,0; 1x 9,0x23,0; 1x 10,0x23,0; 1x 11,0x23,0; 1x 12,0x23,0; 1x 13,0x23,0; 1x 14,0x23,0; 1x 15,0x23,0
+	8767 A HF 1x TX 8x28,0; 1x TX 9x28,0; 1x TX 10x28,0; 1x TX 15x28,0; 1x TX 20x28,0; 1x TX 25x28,0; 1x TX 27x28,0; 1x TX 30x28,0; 1x TX 40x28,0
○	8740 A HF 1x 3,0x28,0; 1x 4,0x28,0; 1x 4,0x100,0; 1x 5,0x28,0; 1x 5,0x100,0; 1x 6,0x28,0; 1x 6,0x100,0; 1x 8,0x28,0; 1x 8,0x100,0
	9820 1x 172,0x30,0x392,0

9721 Schuimrubberen inzetstuk met 8000 B Zyklop ratel 3/8" Set 1



05150111001		
○	8000 B	1x 3/8"x199,0
●○	8794 SB	1x 3/8"x125,0
●○	8794 LB	1x 3/8"x200,0
●○	8795 B	1x 3/8"x50,0
●○	8794 B	1x 3/8"x76,0
●	8790 HMB	1x 6,0x29,0; 1x 7,0x29,0; 1x 8,0x29,0; 1x 9,0x29,0; 1x 10,0x29,0; 1x 11,0x29,0; 1x 12,0x29,0; 1x 13,0x29,0; 1x 14,0x29,0; 1x 15,0x29,0; 1x 16,0x30,0; 1x 17,0x30,0; 1x 18,0x30,0; 1x 19,0x30,0; 1x 20,0x30,0; 1x 21,0x30,0; 1x 22,0x30,0; 1x 24,0x32,0
	9821	1x 172,0x30,0x392,0

9723 Schuimrubberen inzetstuk met Zyklop B 3/8" bitdoppen Set 1



05150113001		
●●	8784 B1	1x 1/4"x3/8"x44,0
⊕	8767 B HF	1x TX 15x35,0; 1x TX 20x35,0; 1x TX 25x35,0; 1x TX 25x107,0; 1x TX 27x35,0; 1x TX 27x107,0; 1x TX 30x35,0; 1x TX 30x107,0; 1x TX 40x35,0; 1x TX 40x107,0
○	8740 B HF	1x 4,0x35,0; 1x 4,0x107,0; 1x 5,0x35,0; 1x 5,0x107,0; 1x 6,0x35,0; 1x 6,0x107,0; 1x 7,0x38,5; 1x 8,0x38,5; 1x 8,0x100,0; 1x 10,0x38,5; 1x 10,0x100,0
	9823	1x 172,0x30,0x392,0

9722 Schuimrubberen inzetstuk met 8000 C Zyklop ratel 1/2" Set 1



05150112001		
○	8000 C	1x 1/2"x277,0
●○	8794 LC	1x 1/2"x250,0
●○	8794 SC	1x 1/2"x125,0
●○	8795 C	1x 1/2"x69,0
●○	8794 C	1x 1/2"x52,0
●	8790 HMC	1x 10,0x37,0; 1x 11,0x37,0; 1x 12,0x37,0; 1x 13,0x37,0; 1x 14,0x37,0; 1x 15,0x37,0; 1x 16,0x37,0; 1x 17,0x37,0; 1x 18,0x37,0; 1x 19,0x37,0; 1x 20,0x37,0; 1x 21,0x37,0; 1x 22,0x37,0; 1x 24,0x37,0; 1x 27,0x40,0; 1x 30,0x42,0; 1x 32,0x42,0
○	8740 C HF	1x 4,0x60,0; 1x 4,0x140,0; 1x 5,0x60,0; 1x 5,0x140,0; 1x 6,0x60,0; 1x 6,0x140,0; 1x 7,0x60,0; 1x 8,0x60,0; 1x 10,0x60,0
	9822	1x 344,0x30,0x392,0

9730 Schuimrubberen inzetstuk met 6000 Joker Set 1



05150120001		
	6000 Joker	1x 8x144; 1x 10x159; 1x 11x165; 1x 12x170,7; 1x 13x177; 1x 14x188; 1x 15x200; 1x 16x212; 1x 17x224; 1x 18x235; 1x 19x246
	9830	1x 172,0x30,0x392,0

9731 Schuimrubberen inzetstuk met 6003 Joker Set 1



05150121001	
6003 Joker	1x 6x105; 1x 7x110; 1x 8x115; 1x 9x120; 1x 10x125; 1x 11x135; 1x 12x148; 1x 13x160; 1x 14x167; 1x 15x174; 1x 16x182; 1x 17x190; 1x 18x210; 1x 19x230,0; 1x 20x230,0; 1x 21x260; 1x 22x260; 1x 24x280
Flesopener	1x 148
9831	1x 344,0x30,0x392,0

9732 Schuimrubberen inzetstuk met 6004 Joker Set 1



05150122001	
6004 Joker XS	1x 7-10 (1/4"-3/8")x117
6004 Joker S	1x 10-13 (7/16"-1/2")x154
6004 Joker M	1x 13-16 (1/2"-5/8")x188
6004 Joker L	1x 16-19 (5/8"-3/4")x224
6004 Joker XL	1x 19-24 (3/4"-15/16")x256
9832	1x 172,0x30,0x392,0

9740 Schuimrubberen inzetstuk met stiftsleutels Set 1

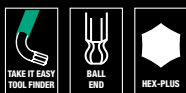

9750 Schuimrubberen inzetstuk met Kraffform Kompakt en Tool-Check PLUS Set 1



05150150001	
1x Tool-Check PLUS	
● 8001 A	1x 1/4"x87,0
● 813	1x 1/4"x78
● 889/4/1 K	1x 1/4"x50
○ 870/1	1x 1/4"x25 ¹⁾
● 8790 HMA	1x 5.5x23.0; 1x 6.0x23.0; 1x 7.0x23.0; 1x 8.0x23.0; 1x 10.0x23.0; 1x 12.0x23.0; 1x 13.0x23.0
⊕ 851/1 TZ	2x PH 1x25; 3x PH 2x25; 1x PH 3x25
⊕ 855/1 TH	1x PZ 1x25; 3x PZ 2x25; 1x PZ 3x25
⊕ 867/1 TZ TORX®	1x TX 10x25; 1x TX 15x25; 1x TX 20x25; 1x TX 25x25; 1x TX 30x25; 1x TX 40x25
⊕ 867/1 Z TORX® BO	1x TX 10x25; 1x TX 15x25; 1x TX 20x25; 1x TX 25x25; 1x TX 30x25
○ 840/1 Z	1x 3.0x25; 1x 4.0x25; 1x 5.0x25; 1x 6.0x25; 1x 8.0x25
⊖ 800/1 TZ	1x 1.0x5.5x25
1x Kraffform Kompakt 60	
● 816 R	1x 1/4"x119
⊕ 851/4 Z	1x PH 1x89; 1x PH 2x89; 1x PH 3x89 ²⁾
⊕ 855/4 Z	1x PZ 1x89; 1x PZ 2x89; 1x PZ 3x89 ²⁾
⊕ 867/4 Z TORX® BO	1x TX 10x89; 1x TX 15x89; 1x TX 20x89; 1x TX 25x89; 1x TX 30x89
⊖ 800/4 Z	1x 1.0x5.5x89
○ 840/4 Z	1x 3.0x89; 1x 4.0x89; 1x 5.0x89; 1x 6.0x89 ²⁾
Klittenbandset 70	1x 50.0x70.0
1x 393 S	
●	1x 1/4"x173,5
1x 9850	
	1x 172,0x30,0x392,0

¹⁾ Met kogel; voor handbediende steeksleutelinzetstukken

²⁾ Zeskantkling

05150140001	
1x 950/9 Hex-Plus Multicolour 1	
○ 950 SPKL Multicolour	1x 1.5x90; 1x 2.0x101; 1x 2.5x112; 1x 3.0x123; 1x 4.0x137; 1x 5.0x154; 1x 6.0x172; 1x 8.0x195; 1x 10.0x224
1x 967/9 TX XL Multicolour 1	
⊕ 967 SXL TORX® Multicolour	1x TX 8x90; 1x TX 9x101; 1x TX 10x112
⊕ 967 SPKXL TORX® Multicolour	1x TX 15x123; 1x TX 20x137; 1x TX 25x154; 1x TX 27x172; 1x TX 30x195; 1x TX 40x224
1x 9500	
	1x 64,6
1x STABILA® rolmaat BM 100, 3 m, artikel 19570	
	1x 3000,0
1x 9840	
	1x 172,0x30,0x392,0

9780 Schuimrubberen inzetstuk met KNIPEX tangen Set 1



05150180001		
	KNIPEX kombitang 03 05 180	1x 180
	KNIPEX Cobra® Hightech-wa-terpomp tang 87 05 250	1x 250
	KNIPEX kracht-zijsnij-tang 74 05 160	1x 160
	9880	1x 172,0x30,0x392,0

9782 Schuimrubberen inzetstuk met hamers Set 1

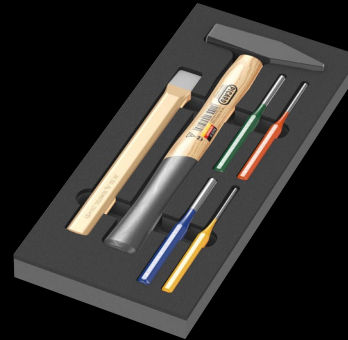

05150182001		
	PICARD® bankha-mer 500 g, 0000101-500	1x 500,0
	RENNSTEIG splitpndrij-vers Exklusiv	1x 452 003 6 RC, 3,0x150; 1x 4520046RC, 4,0x150; 1x 4520066RC, 6,0x150; 1x 452 008 6 RC, 8,0x150
	RENNSTEIG platte beitel 310 250 1	1x 25,0x13,0x23,0
	9882	1x 172,0x30,0x392,0

9781 Schuimrubberen inzetstuk met KNIPEX tangen Set 2

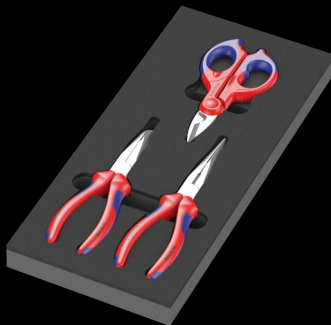

05150181001		
	KNIPEX plat-spitse tang met zijsnijder (Telefoontang) 26 15 200	1x 200
	KNIPEX me-chanicatang 38 25 200	1x 200
	KNIPEX schaar voor elektriciens 95 05 155	1x 155
	9881	1x 172,0x30,0x392,0

9783 Schuimrubberen inzetstuk met PFERD vijlen Set 1

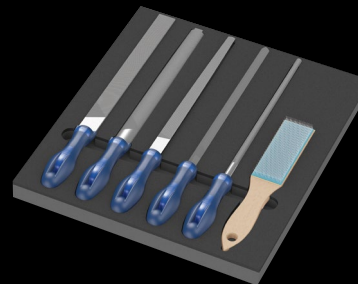

05150183001		
	PFERD vierkante vijl PF1142 250 H2	1x 250
	PFERD half-ronde, spitse vijl 1152SP 250 H2	1x 250
	PFERD ronde vijl 1162 250 H2	1x 250
	PFERD vlak-stompe vijl 1112 250 H2	1x 250
	PFERD drie-kantvijl 1132 250 H2	1x 250
	PFERD vijlborstel HBF staaldraad Ø 0,15	1x 232
	9883	1x 344,0x30,0x392,0



Neem contact met ons op

NL - Centrale regio

Martijn van Houdt
Phone: +31 / 611 06 35 35

E-Mail: vanhoudt@wera.de

NL - Zuid

Wouter Steijvers
Phone: +31 / 652 85 01 62

E-Mail: steijvers@wera.de

NL - Noord

Frederik Koning
Phone: +31 / 615 26 36 97

E-Mail: koning@wera.de

Demovan

Vincent van Gaalen
Phone: +31 / 615 443 719

E-Mail: vangaalen@wera.de

Wij behouden ons het recht voor, alle in deze catalogus genoemde opgaven, productnamen, varianten en uitvoeringen, zonder voorafkondiging te wijzigen. Iedere vorm van aansprakelijkheid m.b.t. druk- en zetfouten is uitgesloten.

www.wera.de