

简易目录



产品目录

螺丝刀



Kraftform 不锈钢螺丝刀	6
Kraftform 增强型 - 900 系列	8
Kraftform 增强型 - 300 系列	11
Flagdriver 旗型螺丝刀系列	28
配件	29
Kraftform 精密系列	32
T 型柄系列	39
ESD 防静电系列	47

电工专用工具



Kraftform 不锈钢 绝缘系列	56
Kraftform 增强型 100 绝缘系列	58
Kraftform Kompakt VDE绝缘系列 Stainless	65
具有棘轮功能的 Kraftform Kompakt VDE	69
Kraftform Kompakt 绝缘系列	71
Kraftform Kompakt Turbo VDE	78
Kraftform - 1000 VDE 绝缘系列	84
400 系列 电设用 T 型柄螺丝刀	86
电工专用Zyklop棘轮和配件	86
Joker VDE 自动可调式开口扳手	90
电工专用扭力工具	91
维拉 2go E 1 电工工具组套	279

棘轮扳手



1/4" Zyklop Speed 棘轮扳手	94
1/4" Zyklop Metal 推杆换向棘轮扳手	99
1/4" Zyklop Metal 拨杆换向棘轮扳手	100
1/4" Zyklop 配件	102
3/8" Zyklop Speed 棘轮扳手	112
3/8" Zyklop 舒适棘轮	116
3/8" Zyklop Metal 推杆换向棘轮扳手	118
3/8" Zyklop Metal 拨杆换向棘轮扳手	120
3/8" Zyklop 配件	122
1/2" Zyklop Speed 棘轮扳手	136
1/2" Zyklop Hybrid 棘轮扳手	139
1/2" Zyklop Metal 推杆换向棘轮扳手	140
1/2" Zyklop Metal 拨杆换向棘轮扳手	141
1/2" Zyklop 配件	142
Zyklop 随身袋	156
1/2" Koloss 锤用棘轮扳手	160
Zyklop Mini 棘轮扳手	172
Tool-Check	163

Joker 扳手



6000 Joker 棘轮两用扳手	176
6001 Joker Switch 拨杆换向棘轮两用扳手	179
6002 Joker 双开口螺丝扳手	181
6003 Joker 组合扳手	181
6004 Joker 自动可调式开口扳手	187
6005 Joker 双开口螺丝扳手	189

L 型扳手



内六角 L 型扳手	192
TORX® 梅花 L 型扳手	207

Kraftform Kompakt



Kraftform Kompakt Turbo	214
Kraftform Kompakt 10, 12	215
Kraftform Kompakt 20, 25, 26, 27, 28	216
Kraftform Kompakt 40, 41	221
Kraftform Kompakt 60, 62	222
Kraftform Kompakt 70, 71	226
Kraftform Kompakt 100	227
Kraftform Kompakt 400	228
Kraftform Kompakt 400 RA	228
Kraftform Kompakt 400 RA 带棘轮功能	229
Kraftform Kompakt 900	231
Kraftform Kompakt Stubby	236
Kraftform Kompakt 行业用户套装	240
螺丝刀杆和转接头	247
Kraftform Kompakt 带棘轮功能	234, 251
Kraftform Kompakt Vario 无棘轮功能	253

车间手推车和泡棉内装插盘



车间手推车	258
车间手推车用泡棉内装插盘	259

Wera 2go



Wera 2go 1 便携组合	276
Wera 2go 2 工具包	276
Wera 2go 3 工具箱	277
Wera 2go 4 工具袋	277
Wera 2go 5 拎袋	277
Wera 2go 6 肩带	278
Wera 2go 7 件加长工具包	278
Wera 2go H 1 工具套装, 木工	278
维拉 2go E 1 电工工具组套	279
Wera 2go SHK 1 工具组套, 用于管道、供暖和空调操作	280
魔术贴	281

批头

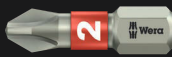

	十字螺丝批头	284
	米字螺丝批头	296
	穿心十字螺丝批头	302
	穿心十字螺丝批头	303
	TORX® 梅花螺丝批头	303
	TORX® B0 防盗梅花螺丝批头	312
	TORX PLUS® 增强型梅花螺丝批头	313
	TORX PLUS® IPR 增强型防盗梅花螺丝批头	314
	一字螺丝批头及专用导向管	314
	内六角螺丝批头	317
	防盗内六角螺丝批头	322
	内四方螺丝批头	324
	TORQ-SET® 四翼螺丝批头	327
	TRI-WING® 三翼螺丝批头	328
	XZN 花键螺丝批头	328
	Microstix® 三叶螺丝批头	328
	双孔防盗螺丝批头	329
	外六角螺丝批头	329
	螺柱批头	331

夹具和转接头



冲击批头接杆	334
快速批头接杆	335
通用快速批头接杆	337
通用批头接杆 带卡环	338
通用批头接杆 带不锈钢护套	338
批头用垫圈	340
转接头	340

批头套装



Bit-Check 冲击批头套装	346
Bit-Check 不锈钢批头套装	349
Bit-Check / Bit-Safe 双重抗扭批头套装	350
Bit-Check 金刚石涂层批头套装	353
Bit-Check / Bit-Safe 通用批头套装	355
Bit-Check 木质工件专用批头套装	363
Bit-Check 金属工件专用批头套装	367
其他特殊用途批头套装	368

扭矩工具



Kraftform 7400 系列扭矩螺丝手柄系列 可调式扭矩螺丝刀手柄	376
预制式扭矩螺丝刀 (原厂预设扭矩值)	381
可根据客户要求可在制造范围内进行定扭	386
Kraftform Safe-Torque Speed 7500 系列扭矩螺丝手柄系列	391
定扭螺丝刀系列	393
Safe-Torque 扭矩扳手及配件	395
Click-Torque 可调式扭矩扳手, 带换向拨杆	398
带方形驱动, 用于顺时针和逆时针扭矩控制	406
可调式扭矩扳手, 适用于开口式工具	407
预制式扭矩扳手, 适用于开口式工具	411
扭矩扳手头	413
扭矩扳手配件	425

冲击螺丝刀



冲击螺丝刀 90 Nm	426
-------------	-----

指数

TechLex	427
螺丝花形尺寸定义	431
扭矩转换表	446



螺丝刀

Kraftform 不锈钢系列 – 避免生锈

维拉的不锈钢工具通过真空冰处理以达到所需硬度和强度，可满足工业级别的应用。

不锈钢材质避免外因锈蚀形成

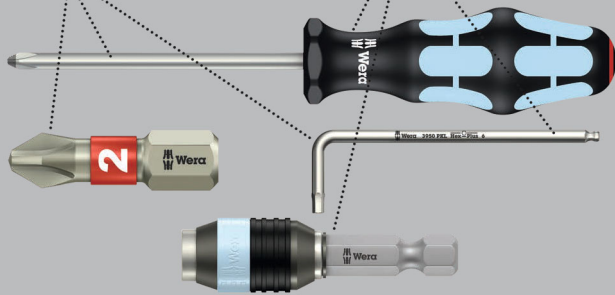

生锈问题的解决方案: 使用不锈钢工具拆装不锈钢螺丝。维拉不锈钢工具是由不锈钢材料制成, 可有效避免难看的锈蚀。维拉的不锈钢工具通过真空冰处理以达到所需硬度和强度, 可满足工业级别的应用。

螺丝刀头用激光蚀刻出带有锋利边缘的沟槽, 其硬度可高达1000 HV 0.3。维拉Lasertip激光蚀刻刀头能抓紧螺丝头, 有效防止打滑, 可适用于一字、十字和梅花螺丝。Kraftform手柄的突出设计使手柄能完美地融入手中, 防止水泡和老茧等手部疲劳造成的损伤。

“Take it easy” 工具易寻色标系统: 通过彩色标识, 辨别螺丝刀头类型与大小。让用户更快的在工具包中找到自己所需要的工具。

- Kraftform多重材料手柄, 符合人体工程学, 可快速拆装螺丝
- “易寻”色标系统: 用特定的颜色代表不同端头种类和尺寸
- 六角防滚动保护, 防止螺丝刀的滚动
- Lasertip激光蚀刻刀头, 可精确配合螺丝头

Lasertip 激光切 – 镭射蚀刻刀头

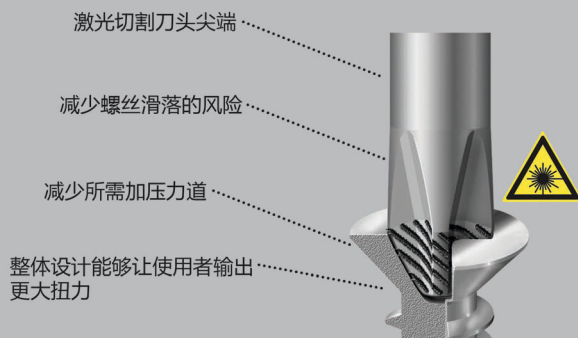

3335 不锈钢一字螺丝刀



	EAN							
Code	4013288	mm	mm	mm	mm	mm	mm	
05032001001 ¹⁾	107329	0,5	3,0	3,0	80	81	1/8"	10
05032002001 ¹⁾	107336	0,6	3,5	3,5	100	81	9/64"	10
05032003001	107343	0,8	4,0	4,0	100	98	5/32"	10
05032004001	107350	1,0	5,5	5,5	125	98	7/32"	10

¹⁾ 不带Lasertip激光蚀刻刀头

3334 不锈钢一字螺丝刀



	EAN							
Code	4013288	mm	mm	mm	mm	mm	mm	
05032005001	107367	1,2	6,5	6,0	150	105	1/4"	10
05032006001	107374	1,2	8,0	7,0	175	112	5/16"	10
05032007001	107381	1,6	10,0	9,0	200	112	3/8"	5

3350 PH 不锈钢十字螺丝刀



	EAN							
Code	4013288		mm	mm	mm	mm	mm	
05032020001 ¹⁾	107398	PH 0	60	81	3,0	2 3/8"		5
05032021001	107404	PH 1	80	98	4,5	3 1/8"		10
05032022001	107411	PH 2	100	105	6,0	4"		10
05032023001	107428	PH 3	150	112	8,0	6"		5

¹⁾ 不带Lasertip激光蚀刻刀头

3355 PZ 不锈钢米字螺丝刀



	EAN	+	mm	mm	mm	mm	
Code	4013288						
05032030001 ¹⁾	107435	PZ 0	60	81	3,0	2 3/8"	5
05032031001	107442	PZ 1	80	98	4,5	3 1/8"	10
05032032001	107459	PZ 2	100	105	6,0	4"	10
05032033001	107466	PZ 3	150	112	8,0	6"	5

¹⁾ 不带Lasertip激光蚀刻刀头

3367 TORX® 不锈钢梅花螺丝刀



	EAN	TORX	mm	mm	mm	mm	
Code	4013288						
05032050001	107473	TX 8	60	81	3,5	2 3/8"	10
05032051001	107480	TX 9	60	81	4,0	2 3/8"	10
05032052001	107497	TX 10	80	81	4,0	3 1/8"	10
05032053001	107503	TX 15	80	98	4,0	3 1/8"	10
05032054001	107510	TX 20	100	98	4,5	4"	10
05032055001	107527	TX 25	100	105	5,0	4"	10
05032056001	107534	TX 27	115	105	5,5	4 9/16"	10
05032057001	107541	TX 30	115	105	6,0	4 9/16"	10
05032058001	107558	TX 40	130	112	7,0	5 3/16"	10

3368 不锈钢方形螺丝刀

- 不锈钢螺丝刀, 用于内四角螺丝
- Kraftform多重材料手柄, 符合人体工程学, 可快速拆装螺丝
- 手柄上的标识方便了工具的寻找和分类
- 六角防滚动保护, 防止螺丝刀的滚动
- 不锈钢, 防止外因锈蚀

3368 不锈钢方形螺丝刀



	EAN	□	mm	mm	mm	mm	
Code	4013288						
05032070002	114150	# 1	80	98	4,5	3 1/8"	10
05032071002	114167	# 2	100	105	6,0	4"	10

3334/6 不锈钢螺丝刀组套 · 带刀架

- 带刀架, 可悬挂在墙上

3334/6 不锈钢螺丝刀组套 · 带刀架



Code	EAN		
05032060001	111388		1
		+	3350 PH 1x PH 1x80; 1x PH 2x100
		-	3335 1x 0,5x3,0x80 ¹⁾ ; 1x 0,8x4,0x100; 1x 1,0x5,5x125
		-	3334 1x 1,2x6,5x150

¹⁾ 不带Lasertip激光蚀刻刀头

3334/3355/6 不锈钢螺丝刀组套 · 带刀架

- 带刀架, 可悬挂在墙上

3334/3355/6 不锈钢螺丝刀组套 · 带刀架



Code	EAN		
05032061001	111395		1
		+	3355 PZ 1x PZ 1x80; 1x PZ 2x100
		-	3335 1x 0,5x3,0x80 ¹⁾ ; 1x 0,8x4,0x100; 1x 1,0x5,5x125
		-	3334 1x 1,2x6,5x150

¹⁾ 不带Lasertip激光蚀刻刀头

3334/3350/3355/6 不锈钢螺丝刀组套·带刀架

- 带刀架,可悬挂在墙上

3334/3350/3355/6 不锈钢螺丝刀组套·带刀架



Code	EAN		
05032063001	111739		1
		3350 PH 1x PH 1x80; 1x PH 2x100	
		3355 PZ 1x PZ 1x80; 1x PZ 2x100	
		3335 1x 0,5x3,0x80 ¹⁾	
		3334 1x 1,2x6,5x150	

¹⁾ 不带Lasertip激光蚀刻刀头

Wera 维拉凿用螺丝刀

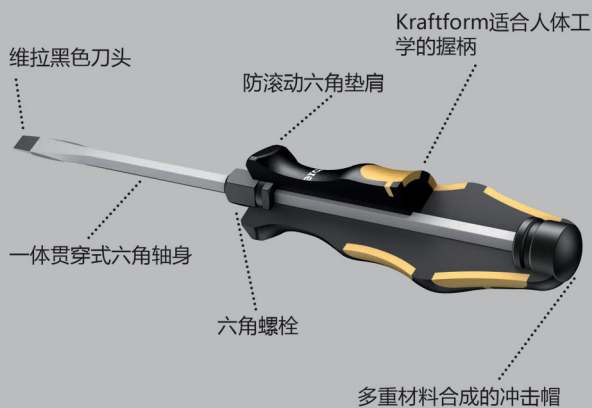

用于紧固和敲凿的两用螺丝刀。手柄的硬质材料使手部皮肤在握持时不会黏着手柄,而周围的大直径硬质区像轮子一样,可以快速转动。优质钢材制成的六角形刀杆贯穿整个手柄,使得用手锤击打的力量也能安全无损地传递。整体回火的材质处理保证刀杆不会碎裂或者折断。

一体式的冲击帽可以延长使用寿命,并且降低碎裂的风险。尽管如此,作业时也请佩戴防护眼镜。通过开口扳手或套筒扳手拧动刀杆上的六角加力螺栓,传输更大扭力。

经过精制硬化处理的维拉黑色刀头,不但可更深入吻合,更具有防腐蚀和较长的使用寿命。六角防滑设计能消除工作中因置放螺丝刀时的滚动而带来的烦恼。

932 A 一字螺丝刀



	EAN	mm	mm	mm	mm	mm	mm	
Code	4013288							
05018260001 ¹⁾	018007	0,6	3,5	4		80	81	10
05018262001	018014	0,8	4,5	5	8	90	98	10
05018264001	018021	1,0	5,5	6	10	100	105	10
05018266001	018038	1,2	7,0	6	10	125	105	10
05018268001	018045	1,6	9,0	8	13	150	112	10
05018270001	018052	1,6	10,0	8	13	175	112	5
05018272001 ²⁾	018069	2,0	12,0	10	16	200	117	2
05018274001 ²⁾	018076	2,5	14,0	10	16	250	117	2

¹⁾ 圆形刀杆, 不带冲击帽和六角螺栓

²⁾ Kraftform单材料手柄, 带防滚动保护

932 A 一字螺丝刀吊卡装



Code	EAN		
05100085001	181596	932 A 1x 1.0x5.5x100	10
05100086001	181602	932 A 1x 1.2x7.0x125	10
05100087001	181619	932 A 1x 1.6x9.0x150	10

932 AS 一字螺丝刀

- 六角形刀杆贯穿整个手柄, 冲击帽带四角套筒, 带加力螺栓

932 AS 一字螺丝刀



	EAN	mm	mm	mm	mm	mm	mm	
Code	4013288							
05018300001	134486	0,8	4,5	5	8	100	98	10
05018301001	134462	1,0	5,5	6	10	113	105	10
05018302001	134455	1,2	7,0	6	10	138	105	10

917 SPH 十字螺丝刀



	EAN	+	Hexagon	mm	mm	mm	mm	mm	mm
Code	4013288								
05017005001	017734	PH 1	5	8	80	98	3 1/8"	10	
05017010001	017741	PH 2	6	10	100	105	4"	10	
05017015001	017758	PH 3	8	13	150	112	6"	5	
05017020001	017765	PH 4	10	16	200	117	8"	2	

917 SPH 十字螺丝刀吊卡装



Code	EAN	+	PH	mm	mm	mm	mm	mm	mm
05100075001	181565	+	917 SPH	1x PH 1x80					10
05100076001	181572	+	917 SPH	1x PH 2x100					10
05100077001	181589	+	917 SPH	1x PH 3x150					5

917 SPHS 十字螺丝刀

- 六角形刀杆贯穿整个手柄，冲击帽带四角套筒，带加力螺栓

917 SPHS 十字螺丝刀



	EAN	+	Hexagon	mm	mm	mm	mm	mm	mm
Code	4013288								
05017040001	134493	PH 1	5	8	90	98	3 35/64"	10	
05017041001	134448	PH 2	6	10	113	105	4 29/64"	10	

918 SPZ 米字螺丝刀



	EAN	☆	Hexagon	mm	mm	mm	mm	mm	mm
Code	4013288								
05017050001	017772	PZ 1	5	8	80	98	3 1/8"	10	
05017052001	017789	PZ 2	6	10	100	105	4"	10	
05017054001	017796	PZ 3	8	13	150	112	6"	5	
05017056001	017802	PZ 4	10	16	200	117	8"	2	

918 SPZ 米字螺丝刀吊卡装



Code	EAN	☆	PH	mm	mm	mm	mm	mm	mm
05100080001	181633	☆	918 SPZ	1x PZ 1x80					10
05100081001	181640	☆	918 SPZ	1x PZ 2x100					10
05100082001	181657	☆	918 SPZ	1x PZ 3x150					5

977 TORX® 梅花螺丝刀



	EAN	☆	Hexagon	mm	mm	mm	mm	mm	mm
Code	4013288								
05024400001	094742	TX 15	5	8	80	98	3 1/8"	10	
05024401001	094759	TX 20	5	8	90	98	3 1/2"	10	
05024402001	094766	TX 25	6	10	100	105	4"	10	
05024403001	094773	TX 27	6	10	125	105	5"	10	
05024404001	094780	TX 30	8	13	150	112	6"	10	
05024405001	094797	TX 40	8	13	150	112	6"	10	

Kraftform 900 螺丝刀大组套：敲击螺丝刀·带刀架

- 带刀架,可悬挂在墙上

Kraftform 900 螺丝刀大组套：敲击螺丝刀·带刀架



Code	EAN		
05133285001	4013288 176349		1
		+	917 SPH 1x PH 1x80; 1x PH 2x100; 1x PH 3x150
		+	918 SPZ 1x PZ 1x80; 1x PZ 2x100; 1x PZ 3x150
		-	932 A 1x 0,6x3,5x80 ¹⁾ ; 1x 0,8x4,5x90; 1x 1,0x5,5x100; 1x 1,2x7,0x125; 1x 1,6x9,0x150
		*	977 TORX® 1x TX 20x90; 1x TX 25x100
			Rack 2x 190,0x50,0

¹⁾ 圆形刀杆, 不带冲击帽和六角螺栓

932/6 Kraftform 螺丝刀组套：敲击螺丝刀·带刀架

- 带刀架,可悬挂在墙上

932/6 Kraftform 螺丝刀组套：敲击螺丝刀·带刀架

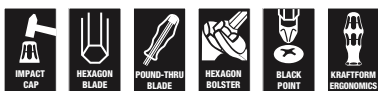

Code	EAN		
05018282001	4013288 018090		1
		+	917 SPH 1x PH 1x80; 1x PH 2x100
		-	932 A 1x 0,6x3,5x80 ¹⁾ ; 1x 0,8x4,5x90; 1x 1,0x5,5x100; 1x 1,2x7,0x125

¹⁾ 圆形刀杆, 不带冲击帽和六角螺栓

932 S/6 Kraftform 螺丝刀组套：敲击螺丝刀·带刀架

- 冲击帽带四角套筒, 带加力螺栓, 传输更大扭力
- 带刀架,可悬挂在墙上

932 S/6 Kraftform 螺丝刀组套：敲击螺丝刀·带刀架



Code	EAN		
05018283001	4013288 134479		1
		+	917 SPHS 1x PH 1x90; 1x PH 2x113
		-	932 A 1x 0,6x3,5x80 ¹⁾
		-	932 AS 1x 0,8x4,5x100; 1x 1,0x5,5x113; 1x 1,2x7,0x138

¹⁾ 圆形刀杆, 不带冲击帽和六角螺栓

932/918/6 Kraftform 螺丝刀组套：敲击螺丝刀·带刀架

- 带刀架,可悬挂在墙上

932/918/6 Kraftform 螺丝刀组套：敲击螺丝刀·带刀架

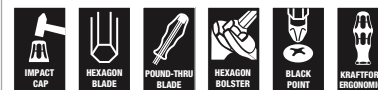

Code	EAN		
05018287001	4013288 018137		1
		+	918 SPZ 1x PZ 1x80; 1x PZ 2x100
		-	932 A 1x 0,6x3,5x80 ¹⁾ ; 1x 0,8x4,5x90; 1x 1,0x5,5x100; 1x 1,2x7,0x125

¹⁾ 圆形刀杆, 不带冲击帽和六角螺栓

977/6 TORX® Kraftform 梅花螺丝刀组套：
敲击螺丝刀·带刀架

- 带刀架, 可悬挂在墙上

977/6 TORX® Kraftform 梅花螺丝刀组套：敲击螺丝刀·带刀架



Code	EAN		
05024410001	4013288 094803		1
		977 TORX® 1x TX 15x80; 1x TX 20x90; 1x TX 25x100; 1x TX 27x125; 1x TX 30x150; 1x TX 40x150	

Kraftform – 符合人体工学的手握设计

符合人体工学的手握设计

符合人体工学设计让手掌能够容易抓取的硬质区

硬质区的材质为保护手掌和让紧固过程更加顺畅尽量减少可能产生的摩擦力

防滚动六角垫肩

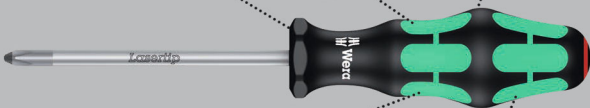

维拉的手柄设计有注册商标让您可一眼就辨识我们的产品

适合手掌肌肉输出更大扭力的软质区

Kraftform手柄的突出设计使手柄能完美地融入手中, 防止水泡和老茧等手部疲劳造成的损伤。

螺丝刀头用激光蚀刻出带有锋利边缘的沟槽, 其硬度可高达1000 HV 0.3。维拉Lasertip激光蚀刻刀头能抓紧螺丝头, 有效防止打滑, 可适用于一字、十字和梅花螺丝。

“Take it easy” 工具易寻色标系统: 通过彩色标识, 辨别螺丝刀头类型与大小。让用户更快的在工具包中找到自己所需要的工具。

六角防滚设计能消除工作中因置放螺丝刀时的滚动而带来的烦恼。

- 光滑的硬质区可在手上快速滑动, 软质抓握区可传递更大扭力
- “易寻”色标系统: 用特定的颜色代表不同端头种类和尺寸
- 六角防滚动保护, 防止螺丝刀的滚动
- Lasertip激光蚀刻刀头, 可精确配合螺丝头

Lasertip 激光切 – 镭射蚀刻刀头

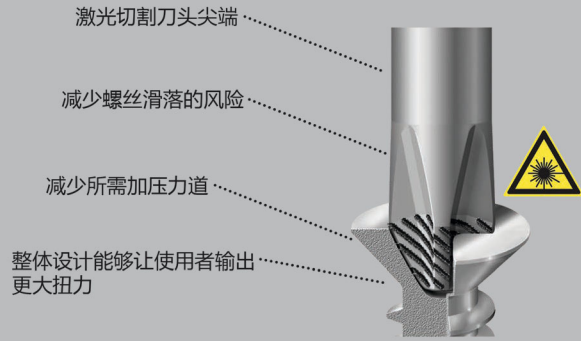

335 一字螺丝刀



	EAN	刀头长度	刀头宽度	刀柄长度	刀柄直径	刀柄直径	刀柄直径	刀柄直径
Code	4013288	mm	mm	mm	mm	mm	mm	mm
05008006001 ¹⁾	039996	0,4	2,0	60	70	2,5	5/64"	10
05110000001 ¹⁾	003232	0,4	2,5	60	70	2,5	3/32"	10
05008007001 ¹⁾	003249	0,4	2,5	75	70	2,5	3/32"	10
05110001001 ¹⁾	003256	0,5	3,0	80	81	3,0	1/8"	10
05008008001 ¹⁾	107985	0,5	3,0	150	81	4,0	1/8"	10
05008009001 ¹⁾	107992	0,5	3,0	200	81	4,0	1/8"	5
05008015001 ¹⁾	003263	0,6	3,5	100	81	3,5	9/64"	10
05110002001 ¹⁾	003270	0,6	3,5	125	81	3,5	9/64"	10
05110003001 ¹⁾	003287	0,6	3,5	200	81	3,5	9/64"	5
05110004001	003294	0,8	4,0	100	98	4,0	5/32"	10
05110005001	003300	0,8	4,0	150	98	4,0	5/32"	10
05110006001	003317	0,8	4,0	200	98	4,0	5/32"	5
05008027001 ¹⁾	003324	0,8	4,0	300	98	4,0	5/32"	2
05110007001	003331	1,0	5,5	125	98	5,5	7/32"	10
05008055001	003348	1,0	5,5	150	98	5,5	7/32"	10
05110008001	003355	1,0	5,5	200	98	5,5	7/32"	5
05008060001 ¹⁾	003362	1,0	5,5	300	98	5,5	7/32"	2
05008061001	108005	1,2	6,0	100	105	6,0	15/64"	10

¹⁾ 不带Lasertip激光蚀刻刀头

335 一字螺丝刀吊卡装



Code	EAN		
05100042001	181275	335	10
05100043001	181251	335	10
05100044001	181244	335	10

334 SK 一字螺丝刀

- 六角形刀杆和加力螺栓传输更大扭力

334 SK 一字螺丝刀



Code	EAN	mm	mm	mm	mm	mm	mm
05007670001 ¹⁾	108036	0,6	3,5	4	-	75	81
05007671001	108043	0,8	4,0	4	-	90	81
05007672001	108050	0,8	4,5	5	8	90	98
05007673001	108067	1,0	5,5	6	10	100	98
05007674001	108074	1,2	6,5	6	10	125	105
05007675001	108081	1,2	7,0	6	10	125	105
05007676001	108098	1,6	9,0	8	13	150	112
05007677001	108104	1,6	10,0	8	13	175	112

¹⁾ 不带Lasertip激光蚀刻刀头

334 一字螺丝刀



Code	EAN	mm	mm	mm	mm	mm	mm
05007610001	003058	0,8	5,0	100	98	5,0	3/16"
05007620001	003065	1,0	6,0	125	105	6,0	1/4"
05340330001	102553	1,0	6,0	150	105	6,0	1/4"
05110010001	003089	1,2	6,5	150	105	6,0	1/4"
05007635001	003072	1,2	7,0	150	105	7,0	9/32"
05007621001	108012	1,2	6,5	200	105	7,0	1/4"
05110011001	003096	1,2	8,0	175	112	7,0	5/16"
05007640001	108029	1,6	8,0	175	112	7,0	5/16"
05110104001	003102	1,6	10,0	200	112	9,0	3/8"
05110105001 ¹⁾	003119	2,0	12,0	250	117	10,0	1/2"

¹⁾ 不带Lasertip激光蚀刻刀头

334 一字螺丝刀吊卡装



Code	EAN		
05100030001	181411	334	10
05100031001	181220	334	5

350 SK PH 十字螺丝刀

- 六角形刀杆和加力螺栓传输更大扭力

350 SK PH 十字螺丝刀



	EAN	+	mm	mm	mm	mm	mm	mm	mm
Code	4013288								
05008750001 ¹⁾	108128	PH 0	4		60	81	2 3/8"		5
05008751001	108135	PH 1	5	8	80	98	3 1/8"		10
05008752001	108142	PH 2	6	10	100	105	4"		10
05008753001	108159	PH 3	8	13	150	112	6"		5

¹⁾ 不带Lasertip激光蚀刻刀头

350 PH 十字螺丝刀



	EAN	+	mm	mm	mm	mm	mm	mm
Code	4013288							
05008705001 ¹⁾	003591	PH 0	60	81	3,0	2 3/8"		5
05008706001 ¹⁾	108111	PH 0	100	81	3,0	4"		5
05008710001	003607	PH 1	80	98	4,5	3 1/8"		10
05008712001	003614	PH 1	200	98	4,5	8"		2
05008715001 ¹⁾	003621	PH 1	300	98	4,5	12"		2
05008720001	003638	PH 2	100	105	6,0	4"		10
05008723001	097996	PH 2	150	105	6,0	6"		10
05008725001	003645	PH 2	200	105	6,0	8"		2
05008730001 ¹⁾	003652	PH 2	300	105	6,0	12"		2
05008735001	003669	PH 3	150	112	8,0	6"		5
05008740001 ¹⁾	003676	PH 4	200	112	10,0	8"		2

¹⁾ 不带Lasertip激光蚀刻刀头

350 PH 十字螺丝刀吊卡装



	EAN	+	Code	Code
Code	4013288			
05100050001	181329	+	350 PH	10
			1x PH 0x60 ¹⁾	
05100051001	181336	+	350 PH	10
			1x PH 1x80	
05100052001	181343	+	350 PH	10
			1x PH 2x100	

¹⁾ 不带Lasertip激光蚀刻刀头

355 SK PZ 米字螺丝刀

- 六角形刀杆和加力螺栓传输更大扭力

355 SK PZ 米字螺丝刀



	EAN	+	mm	mm	mm	mm	mm	mm
Code	4013288							
05009340001 ¹⁾	108180	PZ 0	4		60	81	2 3/8"	5
05009341001	108197	PZ 1	5	8	80	98	3 1/8"	10
05009342001	108203	PZ 2	6	10	100	105	4"	10
05009343001	108210	PZ 3	8	13	150	112	6"	5

¹⁾ 不带Lasertip激光蚀刻刀头

355 PZ 米字螺丝刀



	EAN	✦	⌀	⌀	⌀	⌀		
Code	4013288		mm	mm	mm	mm		
05009305001 ¹⁾	004024	PZ 0	60	81	3,0	2 3/8"		10
05009310001	004031	PZ 1	80	98	4,5	3 1/8"		10
05009312001	004048	PZ 1	200	98	4,5	8"		2
05009313001 ¹⁾	108166	PZ 1	300	98	4,5	12"		2
05009315001	004055	PZ 2	100	105	6,0	4"		10
05009317001	004062	PZ 2	200	105	6,0	8"		2
05347743001	097040	PZ 2	250	105	6,0	10"		2
05009319001 ¹⁾	108173	PZ 2	300	105	6,0	12"		2
05009320001	004079	PZ 3	150	112	8,0	6"		5
05009325001 ¹⁾	004086	PZ 4	200	112	10,0	8"		2

¹⁾ 不带Lasertip激光蚀刻刀头

355 PZ 米字螺丝刀吊卡装



Code	EAN			
	4013288			
05100055001	181282	✦	355 PZ 1x PZ 0x60 ¹⁾	10
05100056001	181299	✦	355 PZ 1x PZ 1x80	10
05100057001	181305	✦	355 PZ 1x PZ 2x100	10

¹⁾ 不带Lasertip激光蚀刻刀头

增强型内六角- 专门针对六角型螺丝的设计

如图可看到和螺槽的接触面积大幅度的增加 因此减少了
转位时各个面所承受的压力

从而避免破坏螺槽的轮廓

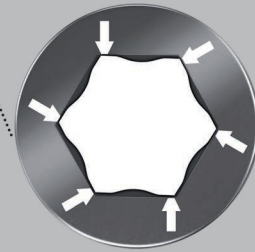

Kraftform手柄的突出设计使手柄能完美地融入手中, 防止水泡和老茧等手部疲劳造成的损伤。既有的内六角螺丝工具存在一个问题, 由于从工具传递外力到螺丝的接触面很窄, 导致螺丝头可能会损坏, 通常是凹处被磨圆。

Hex-Plus六角增强型工具有较大的接触面, 它从凹槽的平面处驱动螺丝, 而不是从角面, 可防止这种损坏。Hex-Plus工具适合每一个标准内六角螺丝。

“Take it easy” 工具易寻色标系统: 通过彩色标识, 辨别螺丝刀头类型与大小。让用户更快的在工具包中找到自己所需要的工具。六角防滚设计能消除工作中因置放螺丝刀时的滚动而带来的烦恼。

- 六角形螺丝刀, Hex-Plus六角增强型
- Hex-Plus六角增强型可延长螺丝头的寿命

354 内六角螺丝刀



	EAN	⊙	⌀	⌀	⌀	⌀		
Code	4013288		mm	mm	mm	mm		
05023105001	003942	⊙	2,0	75	70	3,0	3"	5
05023107001	003959	⊙	2,5	75	81	3,0	3"	10
05023110001	003966	⊙	3,0	75	81	4,0	3"	10
05023115001	003973	⊙	4,0	75	98	5,0	3"	10
05023120001	003980	⊙	5,0	80	105	6,0	3 1/8"	10
05023125001	003997	⊙	6,0	80	105	7,0	3 1/8"	5
05023130001	004000	⊙	8,0	100	112	10,0	4"	5

352 球头内六角螺丝刀

- 六角形刀杆和球头, 在难以进入的工况下也可安全作业

352 球头内六角螺丝刀



	EAN	⊙	⊙	⌞	⌞	⌞		
Code	4013288	mm	mm	mm	mm	mm		
05022795001	032577	1,5		60	70	2 3/8"		10
05022800001	003751	2,0		100	70	4"		10
05138070001	003768	2,5		100	81	4"		10
05022805001	003775	3,0		100	81	4"		10
05022810001	003782	4,0		100	98	4"		10
05022815001	003799	5,0		100	105	4"		10
05022820001	003805	6,0		125	105	5"		5
05022825001	003812	8,0		150	112	6"		5
05022830001	003829	10,0		150	112	6"		5
05022835001	003836	12,0		150	117	6"		5
05022905001	003843		5/32"	100	98	4"		5
05022910001	003850		3/16"	100	105	4"		5
05022920001	003874		1/4"	125	105	5"		5

梅花齿廓固持工具系列

卡紧梅花型螺丝的楔入力

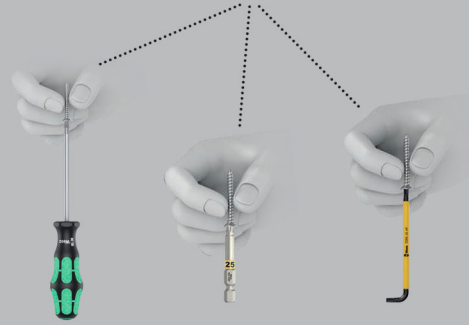

在拆装引擎及其相关工件时, 不可能确保手拿着螺丝刀同时牢牢抓住螺丝, 因此螺丝经常会掉下去, 需要花大量时间去寻找, 否则甚至可能引发危险。维拉开发的HF工具能够有效解决这一问题, 它对原有的TORX® 梅花形状进行了优化, 刀头和螺丝之间的表面压力形成了楔入力, 从而使螺丝能牢固黏着在螺丝刀上。

手柄的硬质材料使手部皮肤在握持时不会黏着手柄, 而周围的大直径硬质区像轮子一样, 可以快速转动。

六角防滚设计能消除工作中因螺丝刀的滚动而带来的烦恼。“Take it easy” 工具易寻色标系统: 通过彩色标识, 辨别螺丝刀头类型与大小。让用户更快的在工具包中找到自己所需要的工具。

- TORX®梅花螺丝用螺丝刀
- TORX®梅花螺丝固持功能
- Kraftform多重材料手柄, 符合人体工程学, 可快速拆装螺丝
- 手柄上的标识方便了工具的寻找和分类
- 六角防滚动保护, 防止螺丝刀的滚动

367 TORX® HF 梅花螺丝刀 · 带固持功能



	EAN	⊙	⌞	⌞	⊘	⌞		
Code	4013288		mm	mm	mm			
05028048001	106643	TX 8	60	81	3,5	2 3/8"		10
05028049001	106650	TX 9	60	81	4,0	2 3/8"		10
05028050001	100696	TX 10	80	81	4,0	3 1/8"		10
05028051001	100702	TX 15	80	98	4,0	3 1/8"		10
05028052001	100719	TX 20	100	98	4,5	4"		10
05028070001	138415	TX 20	300	98	4,5	12"		4
05028053001	100726	TX 25	100	105	5,0	4"		10
05028071001	138408	TX 25	300	105	6,0	12"		4
05028054001	100733	TX 27	115	105	5,5	4 9/16"		10
05028072001	138392	TX 27	300	105	6,0	12"		4
05028055001	100740	TX 30	115	105	6,0	4 9/16"		10
05028073001	138385	TX 30	300	105	6,0	12"		4
05028056001	100757	TX 40	130	112	7,0	5 3/16"		10

367 TORX® 梅花螺丝刀



	EAN						
Code	4013288		mm	mm	mm	"	
05028000001	025852	TX 5	60	70	3,5	2 3/8"	10
05028001001	004185	TX 6	60	70	3,5	2 3/8"	10
05028002001	004192	TX 7	60	70	3,5	2 3/8"	10
05028003001	004208	TX 8	60	81	3,5	2 3/8"	10
05028004001	004215	TX 9	60	81	4,0	2 3/8"	10
05028005001	004222	TX 10	80	81	4,0	3 1/8"	10
05028008001	004239	TX 15	80	98	4,0	3 1/8"	10
05028010001	004246	TX 20	100	98	4,5	4"	10
05028012001	004253	TX 25	100	105	5,0	4"	10
05028013001	004260	TX 27	115	105	5,5	4 9/16"	10
05028015001	004277	TX 30	115	105	6,0	4 9/16"	10
05028020001	004284	TX 40	130	112	7,0	5 1/8"	10

367 TORX® 梅花螺丝刀吊卡装



Code	EAN			
	4013288			
05100060001	181350		367 TORX® 1x TX 10x80	10
05100061001	181367		367 TORX® 1x TX 15x80	10
05100062001	181374		367 TORX® 1x TX 20x100	10
05100063001	181381		367 TORX® 1x TX 25x100	10
05100064001	181398		367 TORX® 1x TX 30x115	10

367 TORX® B0 防盗梅花螺丝刀

带安全销的TORX®工具可防止安全螺丝被随意拆卸。这些防盗螺丝头有伸出到齿廓的安全销，普通的TORX®工具无法使用，而TORX® B0工具的孔可与其相匹配，从而拆卸安全螺丝。

手柄的硬质材料使手部皮肤在握持时不会黏着手柄，而周围的大直径硬质区像轮子一样，可以快速转动。

经过精制硬化处理的维拉黑色刀头，不但可更深入吻合，更具有防腐蚀和较长的使用寿命。

六角防滚设计能消除工作中因置放螺丝刀时的滚动而带来的烦恼。手柄上的螺丝符号和端头尺寸识别标记可以更容易地找到工具箱内或作业场所的合适螺丝刀。

- 用于TORX®防盗梅花螺丝

367 TORX® B0 防盗梅花螺丝刀



	EAN						
Code	4013288		mm	mm	mm	"	
05138257001	039965	TX 7	60	70	3,5	2 3/8"	5
05138258001	039972	TX 8	60	81	3,5	2 3/8"	5
05138259001	039989	TX 9	60	81	4,0	2 3/8"	5
05138260001	025869	TX 10	80	81	4,0	3 1/8"	5
05138268001	108234	TX 10	300	81	4,0	12"	5
05138261001	025876	TX 15	80	98	4,0	3 1/8"	5
05138269001	108241	TX 15	300	98	4,0	12"	2
05138262001	025883	TX 20	100	98	4,5	4"	5
05138270001	108258	TX 20	300	98	4,5	12"	2
05138263001	025890	TX 25	100	105	5,0	4"	5
05138264001	025906	TX 27	115	105	5,5	4 9/16"	5
05138265001	025913	TX 30	115	105	6,0	4 9/16"	5
05138266001	025920	TX 40	130	112	7,0	5 1/8"	5

367 TORX PLUS® 增强型梅花螺丝刀

与常规的圆形TORX®齿廓相比，TORX PLUS®工具的椭圆形齿廓扩大了工具和螺丝之间传递扭矩的6个侧面，因此拆装螺丝时的外力分布在一个较大的表面积上，可传递更高的扭矩，并且延长了螺丝和工具的使用寿命。切割工具中的“中心锁定螺丝”代表了这种螺丝外形的典型应用。硬质合金刀片顶端夹具的热影响经常“烘烤”固定螺丝，需要有一个形状来大幅增强拧螺丝时的扭矩。

为此，扭矩稳定的螺钉外形可避免螺丝可能产生的伤害、减少昂贵的停机时间。手柄的硬质材料使手部皮肤在握持时不会黏着手柄，而周围的大直径硬质区像轮子一样，可以快速转动。经过精制硬化处理的维拉黑色刀头，不但可更深入吻合，更具有防腐蚀和较长的使用寿命。六角防滚设计能消除工作中因置放螺丝刀时的滚动而带来的烦恼。手柄上的螺丝符号和端头尺寸识别标记可以更容易地找到工具箱内或作业场所的合适螺丝刀。

367 TORX PLUS® 增强型梅花螺丝刀



Code	EAN						
			mm	mm	mm		
05028029001	041555	5 IP	60	70	3,5	2 3/8"	5
05028030001	040091	6 IP	60	70	3,5	2 3/8"	5
05028031001	040107	7 IP	60	70	3,5	2 3/8"	5
05028032001	040114	8 IP	60	70	3,5	2 3/8"	5
05028033001	040121	9 IP	60	81	4,0	2 3/8"	5
05028034001	040138	10 IP	80	81	4,0	3 1/8"	5
05028035001	040145	15 IP	80	98	4,0	3 1/8"	5
05028036001	040152	20 IP	100	98	4,5	4"	5
05028037001	040169	25 IP	100	105	5,0	4"	5
05028038001	040176	30 IP	115	105	6,0	4 9/16"	5

368 方形头螺丝刀

手柄的硬质材料使手部皮肤在握持时不会黏着手柄，而周围的大直径硬质区像轮子一样，可以快速转动。经过精制硬化处理的维拉黑色刀头，不但可更深入吻合，更具有防腐蚀和较长的使用寿命。

六角防滚设计能消除工作中因置放螺丝刀时的滚动而带来的烦恼。手柄上的螺丝符号和端头尺寸识别标记可以更容易地找到工具箱内或作业场所的合适螺丝刀。

368 方形头螺丝刀



Code	EAN						
			mm	mm	mm		
05117680001	028723	# 00	60	81	3,5	2 3/8"	5
05117681001	028730	# 0	60	81	4,0	2 3/8"	5
05117682001	028747	# 1	80	98	4,5	3 1/8"	5
05117683001	028754	# 1	200	98	4,5	8"	5
05117684001	028761	# 2	100	105	6,0	4"	5
05117685001	028778	# 2	200	105	6,0	8"	5
05117691001	040916	# 2	300	105	6,0	12"	2
05117686001	028785	# 3	150	112	8,0	6"	5
05117687001	028792	# 4	200	112	8,0	8"	5

368 方形头螺丝刀吊卡装



Code	EAN		
	4013288		
05100070001	181404	368 1x # 1x80	5
05100071001	181428	368 1x # 2x100	5
05100072001	181435	368 1x # 3x150	5

338 接线盒驱动工具 (弹簧笼)

- 用于电气线路端子中解锁触点的特殊工具
- 由于采用了曲线几何结构, 因此可以操作普通螺丝刀无法触及的接线盒
- 适用于导体横截面最高为 1.5 mm² 和 2.5 至 4.0 mm² 的弹簧端子

338 接线盒驱动工具 (弹簧笼)



	EAN							
Code	4013288	mm	mm	mm	mm	mm		
05008101001	225641	0,4	2,5	81	81	2,5	3/32"	10
05008102001	225788	0,6	3,5	81	81	3,5	9/64"	10

391 六角软管螺帽螺丝刀

- 软管螺丝刀, 用于六角头
- 圆形柔性杆

391 六角软管螺帽螺丝刀



	EAN						
Code	4013288	mm	mm	mm			
05028148001	004703	6	167	98	6 9/16"		5
05028150001	004710	7	167	98	6 9/16"		5
05028152001	004727	8	167	98	6 9/16"		5

395 螺帽螺丝刀

- 螺母螺丝刀, 用于六角头螺丝

395 螺帽螺丝刀



	EAN						
Code	4013288	mm	mm	mm	mm		
05028205001	004734	3,0	125	98	5,0	5"	5
05028210001	004741	3,5	125	98	6,1	5"	5
05028215001	004758	4,0	125	98	6,9	5"	5
05028220001	004765	4,5	125	98	7,1	5"	5
05028225001	004772	5,0	125	98	8,1	5"	5
05028230001	004789	5,5	125	98	8,1	5"	5
05029405001	004796	6,0	125	98	9,1	5"	5
05029410001	004802	7,0	125	105	11,0	5"	5
05029415001	004819	8,0	125	105	12,1	5"	5
05029420001	004826	9,0	125	105	13,1	5"	5
05029425001	004833	10,0	125	112	14,1	5"	5
05029430001	004840	11,0	125	112	16,0	5"	5
05029435001	004857	12,0	125	112	17,1	5"	5
05029440001	004864	13,0	125	112	18,1	5"	5
05029445001	004871	14,0	125	112	19,1	5"	5
05029450001	004888	15,0	125	112	21,0	5"	5

395 HO 螺帽螺丝刀

拆装长螺杆上的螺帽时需要使用带空心杆的螺丝刀, 例如: 螺杆可通过螺帽滑入螺丝刀的空心杆内。

手柄的硬质材料使手部皮肤在握持时不会黏着手柄, 而周围的大直径硬质区像轮子一样, 可以快速转动。

六角防滚设计能消除工作中因置放螺丝刀时的滚动而带来的烦恼。

手柄上的螺丝符号和端头尺寸识别标记可以更容易地找到工具箱内或作业场所的合适螺丝刀。

- 螺母螺丝刀, 用于六角头螺丝
- 空心刀杆适用于长螺杆, 镀铬

395 HO 螺帽螺丝刀



	EAN							
Code	4013288	mm		mm	mm	mm		
05029460001	108296	5,0		90	98	7,2	3 35/64"	5
05029461001	108302	5,5		90	98	7,2	3 35/64"	5
05029462001	108319	6,0		90	98	7,2	3 35/64"	5
05029463001	108326	7,0		90	105	7,2	3 35/64"	5
05029464001	108333	8,0		90	105	9,3	3 35/64"	5
05029465001	108340	10,0		90	112	9,3	3 35/64"	5
05029466001	108357	13,0		90	112	11,0	3 35/64"	5
05029501001	110503		3/16"	90	98	7,2	3 35/64"	5
05029502001	110510		1/4"	90	98	7,2	3 35/64"	5
05029503001	110527		5/16"	90	105	9,3	3 35/64"	5
05029504001	110534		11/32"	90	105	9,3	3 35/64"	5
05029505001	110541		3/8"	90	112	9,3	3 35/64"	5
05029506001	110558		7/16"	90	112	11,0	3 35/64"	5
05029507001	110565		1/2"	90	112	11,0	3 35/64"	5

Take it easy 彩色工具搜寻系统 – 快速辨识

批头 “Take it easy” 工具搜寻系统 – 让使用者能够简捷地辨识运用不同颜色选取需要的

Zyklop 套筒 “Take it easy” 工具搜寻系统 – 让使用者能够简捷地运用不同颜色辨识选取需要的

L型扳手 “Take it easy” 工具搜寻系统 – 让使用者能够简捷地运用不同颜色辨识选取需要的尺寸

Joker两用棘轮扳手 “Take it easy” 工具搜寻系统 – 让使用者能够简捷地运用不同颜色辨识选取需要的工具

带有短刀杆的迷你螺丝刀, 用于难以进入的狭小空间。双重材料手柄有硬质和软质区, 确保牢固握抓并精确作业。刀杆全方位体现维拉工艺技术的优势。刀杆表面经特殊处理, 具有良好抗腐蚀性和高装配精度。六角防滚保护有效防止了操作时打滑的危险。

- 小巧设计适合狭小空间内作业
- 符合人体工程学的双重材料 Kraftform 手柄提升作业精确度
- 全方面体现维拉工艺技术优势的刀杆
- 六角防滚动保护, 防止螺丝刀的滚动
- “易寻”色标系统: 用特定的颜色代表不同端头种类和尺寸

335 Stubby/迷你螺丝刀



	EAN							
Code	4013288	mm	mm	mm	mm	mm		
05008840001	212115	0,6	3,5	24,5	54	3,5	9/64"	5
05008841001	212122	0,8	4,0	24,5	54	4,0	5/32"	5
05008842001	212139	1,0	5,5	24,5	54	5,5	7/32"	5
05008843001	212146	1,2	6,5	24,5	54	6,5	1/4"	5
05008844001	212153	1,2	7,0	24,5	54	8,0	5/16"	5

350 PH 十字 Stubby/迷你螺丝刀



	EAN	+	柄长	柄宽	柄径	柄厚	包装
Code	4013288		mm	mm	mm		
05008850001	212160	PH 1	25	54	4,2	1"	5
05008851001	212177	PH 2	25	54	5,2	1"	5
05008852001	212184	PH 3	25	54	6,2	1"	5

355 PZ 米字 Stubby/迷你螺丝刀

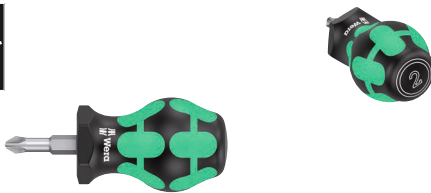

	EAN	*	柄长	柄宽	柄径	柄厚	包装
Code	4013288		mm	mm	mm		
05008853001	212191	PZ 1	25	54	4,5	1"	5
05008854001	212207	PZ 2	25	54	6,0	1"	5
05008855001	212214	PZ 3	25	54	8,0	1"	5

367 TORX® Stubby 迷你螺丝刀



	EAN	*	柄长	柄宽	柄径	柄厚	包装
Code	4013288		mm	mm	mm		
05008856001	212245	TX 10	25	54	3,4	1"	5
05008857001	212252	TX 15	25	54	3,7	1"	5
05008858001	212269	TX 20	25	54	4,0	1"	5
05008859001	212276	TX 25	25	54	4,5	1"	5
05008860001	212283	TX 27	25	54	5,1	1"	5
05008861001	212290	TX 30	25	54	5,6	1"	5
05008862001	212306	TX 40	25	54	-	1"	5

368 Stubby 内四方迷你螺丝刀

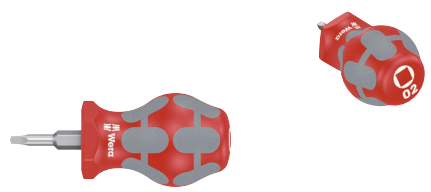

	EAN	□	柄长	柄宽	柄径	柄厚	包装
Code	4013288		mm	mm	mm		
05008863001	212313	# 01	25	54	4,2	1"	5
05008864001	212320	# 02	25	54	4,2	1"	5

9650 磁性条带 Kraftform 螺丝刀组套

接线盒上的 Kraftform 螺丝刀组套, 9件组套。螺丝刀全能组套。Kraftform Plus 手柄, 符合人体工学设计的舒适旋拧操作舒适, 可避免出现起泡和老茧。

硬质手柄区域, 适合较高的操作速度, 软质手柄区域则适用于高扭矩传输。

32 A, 带磅通六角刀杆和冲击盖; 350、355 和 335, 带 Lasertip: Wera Lasertip 螺丝刀的刀尖采用激光束在显微镜下进行了粗糙化处理。这种粗糙的表面可以“咬住”螺丝头, 消除意外滑动。160 iS VDE 绝缘, 带有 Lasertip。

“Take it easy” 工具查找装置, 根据型面进行颜色编码和尺寸压印标记, 可快速方便地找到所需工具。

条形端头完全固定住工具。凭借其强大的磁性, 该条可以牢牢地吸附在金属表面。条带也可以用螺栓固定在墙上。

- 适用于所有场合的工具
- 条形端头完全固定住工具
- 凭借其强大的磁性, 该条可以牢牢地吸附在金属表面。条带也可以用螺栓固定在墙上

9650 磁性条带 Kraftform 螺丝刀组套



Code	EAN	内容	包装
05051012001	228970	<ul style="list-style-type: none"> 932 A 1x 1,0x5,5x100; 1x 1,2x7,0x125 350 1x PH 2x100 355 1x PZ 1x80; 1x PZ 2x100 367 TORX® 1x TX 20x100; 1x TX 25x100 335 1x 0,8x4,0x100 160 iS VDE 1x 0,6x3,5x100 9611 1x 30,0x400,0 	1

Kraftform 300 大组套

- 一字、十字、米字和TORX®梅花螺丝用螺丝刀

Kraftform 300 大组套



Code	EAN		
05105630001	4013288 163622		1
		350 PH 1x PH 1x80; 1x PH 2x100; 1x PH 3x150	
		355 PZ 1x PZ 1x80; 1x PZ 2x100; 1x PZ 3x150	
		367 TORX® 1x TX 10x80; 1x TX 15x80; 1x TX 20x100; 1x TX 25x100; 1x TX 30x115	
		334 1x 1,2x6,5x150	
		335 1x 0,6x3,5x100 ¹⁾ ; 1x 0,8x4,0x100	
		Rack 2x 190,0x50,0	

¹⁾ 不带Lasertip激光蚀刻刀头

Kraftform XXL 螺丝刀组套

- 适用于所有场合的工具

Kraftform XXL 螺丝刀组套



Code	EAN		
05051010001	4013288 139092		1
		350 PH 1x PH 1x80; 1x PH 2x100	
		355 PZ 1x PZ 1x80; 1x PZ 2x100	
		932 A 1x 1,0x5,5x100; 1x 1,2x7,0x125	
		334 1x 1,2x6,5x150	
		335 1x 0,8x4,0x100; 1x 1,0x5,5x125	
		160 i VDE 1x 0,4x2,5x80 ¹⁾ ; 1x 0,6x3,5x100 ¹⁾	
		247 1x 0,5x3,0x70	
		Rack 2x 190,0x50,0	

¹⁾ 不带Lasertip激光蚀刻刀头

²⁾ 未在美国和加拿大上市

Kraftform XXL 2 螺丝刀组套



Code	EAN		
	4013288		
05051011001	144225		1
		350 PH 1x PH 2x100	
		355 PZ 1x PZ 1x80; 1x PZ 2x100	
		932 A 1x 1,0x5,5x100; 1x 1,2x7,0x125	
		335 1x 0,8x4,0x100	
		367 TORX® 1x TX 15x80; 1x TX 20x100; 1x TX 25x100	
		160 i VDE 1x 0,4x2,5x80 ¹⁾ ; 1x 0,6x3,5x100 ¹⁾	
		247 1x 0,5x3,0x70	
		Rack 2x 190,0x50,0	

¹⁾ 不带Lasertip激光蚀刻刀头
²⁾ 未在美国和加拿大上市

Kraftform XXL 3 螺丝刀组套



Code	EAN		
	4013288		
05347106001	182388		1
		932 A 1x 1,0x5,5x100; 1x 1,2x7,0x125	
		350 PH 1x PH 1x80; 1x PH 2x100	
		334 1x 1,2x6,5x150	
		335 1x 0,8x4,0x100; 1x 1,0x5,5x125	
		368 1x # 1x80; 1x # 2x100	
		160 i VDE 1x 0,4x2,5x80 ¹⁾ ; 1x 0,6x3,5x100 ¹⁾	
		Rack 2x 190,0x50,0	

¹⁾ 不带Lasertip激光蚀刻刀头

Kraftform 2go 300系列套装

11件Kraftform 螺丝刀。“Take it easy” 易寻色标系统：以颜色区别头花形与尺寸。附带一个可靠耐用工具织布袋，带把手，方便运输与携带；耐刀割与穿刺，带魔术贴。

- 带尼龙魔术贴，可粘贴到Wera 2go系列工具箱包上。

Kraftform 2go 300系列套装



Code	EAN		
	4013288		
05004313001	187833		1
		Wera 2go 4 1x 165,0x165,0x105,0	
		350 PH 1x PH 1x80; 1x PH 2x100	
		355 PZ 1x PZ 1x80; 1x PZ 2x100	
		367 TORX® 1x TX 10x80; 1x TX 15x80; 1x TX 20x100; 1x TX 25x100; 1x TX 30x115	
		334 SK 1x 0,8x4,5x90; 1x 1,2x7,0x125	
		K120 1x 50,0x120,0	

334 SK/6 Kraftform Plus 螺丝刀组套 · Lasertip · 带刀架

- 六角形刀杆和加力螺栓传输更大扭力

334 SK/6 Kraftform Plus 螺丝刀组套 · Lasertip · 带刀架



Code	EAN		
	4013288		
05007680001	111418		1
		350 SK PH 1x PH 1x80; 1x PH 2x100	
		334 SK 1x 0,6x3,5x75 ¹⁾ ; 1x 0,8x4,0x90; 1x 1,0x5,5x100; 1x 1,2x6,5x125	

¹⁾ 不带Lasertip激光蚀刻刀头

334/6 Kraffform Plus 螺丝刀组套 · Lasertip · 带刀架



Code	EAN		
05105650001	4013288 003133		1
		+	350 PH 1x PH 1x80; 1x PH 2x100
		-	334 1x 1,2x6,5x150
		-	335 1x 0,5x3,0x80 ¹⁾ ; 1x 0,8x4,0x100; 1x 1,0x5,5x125

¹⁾ 不带Lasertip激光蚀刻刀头

334/355 SK/6 Kraffform Plus 螺丝刀组套 · Lasertip · 带刀架

- 六角形刀杆和加力螺栓传输更大扭力

334/355 SK/6 Kraffform Plus 螺丝刀组套 · Lasertip · 带刀架



Code	EAN		
05007681001	4013288 111425		1
		+	355 SK PZ 1x PZ 1x80; 1x PZ 2x100
		-	334 SK 1x 0,6x3,5x75 ¹⁾ ; 1x 0,8x4,0x90; 1x 1,0x5,5x100; 1x 1,2x6,5x125

¹⁾ 不带Lasertip激光蚀刻刀头

334/355/6 Kraffform Plus 螺丝刀组套 · Lasertip · 带刀架



Code	EAN		
05105656001	4013288 003140		1
		+	355 PZ 1x PZ 1x80; 1x PZ 2x100
		-	334 1x 1,2x6,5x150
		-	335 1x 0,5x3,0x80 ¹⁾ ; 1x 0,8x4,0x100; 1x 1,0x5,5x125

¹⁾ 不带Lasertip激光蚀刻刀头

335/350/355/6 Kraffform Plus 螺丝刀组套 · Lasertip · 带刀架



Code	EAN		
05105622001	4013288 041616		1
		+	350 PH 1x PH 1x80; 1x PH 2x100
		+	355 PZ 1x PZ 1x80; 1x PZ 2x100
		-	335 1x 0,8x4,0x100; 1x 1,0x5,5x125

335/350/355/3 Kraftform Plus 螺丝刀组套 · 带固持功能 · 刀杆长300 mm

- 超长刀杆用于低洼的安装工况

335/350/355/3 Kraftform Plus 螺丝刀组套 · 带固持功能 · 刀杆长300 mm

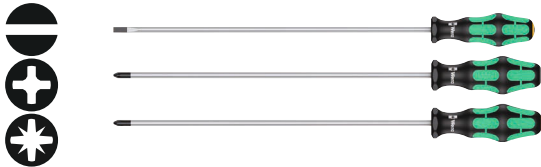

Code	EAN		
05347735002	120991		1
		335 1x 1,0x5,5x300 ¹⁾	
		350 PH 1x PH 2x300 ¹⁾	
		355 PZ 1x PZ 2x300 ¹⁾	

¹⁾ 不带Lasertip激光蚀刻刀头

335/350/355/4 Kraftform Plus 螺丝刀组套 · 激光蚀刻刀头 · 带固持功能 · 刀杆长200mm

- 超长刀杆用于低洼的安装工况

335/350/355/4 Kraftform Plus 螺丝刀组套 · 激光蚀刻刀头 · 带固持功能 · 刀杆长200mm



Code	EAN		
05347736002	117397		1
		350 PH 1x PH 2x200	
		355 PZ 1x PZ 1x200; 1x PZ 2x200	
		335 1x 1,0x5,5x200	

335/350/367/7 Kraftform Plus 螺丝刀组套 · Lasertip · 带刀架



Code	EAN		
05320540001	094704		1
		350 PH 1x PH 2x100	
		355 PZ 1x PZ 1x80; 1x PZ 2x100	
		335 1x 0,8x4,0x100	
		367 TORX® 1x TX 15x80; 1x TX 20x100; 1x TX 25x100	

367/7 Kraftform Plus TORX® HF 梅花螺丝刀组套 · 带固持功能 · 带刀架

- TORX®梅花螺丝固持功能, 镀铬

367/7 Kraftform Plus TORX® HF 梅花螺丝刀组套 · 带固持功能 · 带刀架



Code	EAN		
05223161001	118226		1
		367 TORX® HF 1x TX 8x60; 1x TX 10x80; 1x TX 15x80; 1x TX 20x100; 1x TX 25x100; 1x TX 27x115; 1x TX 30x115	

367/6 Kraftform Plus TORX® HF 螺丝刀组套 · 带固持功能 · 带刀架



Code		EAN		
05028059001		4013288	100764	1
		367 TORX® HF		
		1x TX 10x80; 1x TX 15x80; 1x TX 20x100;		
		1x TX 25x100; 1x TX 30x115; 1x TX 40x130		

367/4 Kraftform Plus TORX® HF 螺丝刀组套 · 带固持功能 · 300 mm 加长型刀杆

- TORX®梅花螺丝用螺丝刀, 带固持功能, 300mm超长刀杆

367/4 Kraftform Plus TORX® HF 螺丝刀组套 · 带固持功能 · 300 mm 加长型刀杆

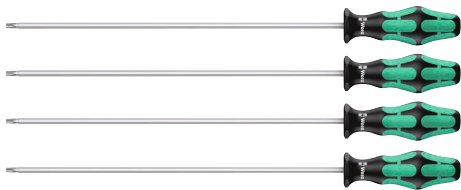

Code		EAN		
05028074001		4013288	138378	1
		367 TORX® HF		
		1x TX 20x300; 1x TX 25x300; 1x TX 27x300;		
		1x TX 30x300		

367/6 TORX® Kraftform Plus 螺丝刀组套 · 带刀架



Code		EAN		
05028062001		4013288	028891	1
		367 TORX®		
		1x TX 10x80; 1x TX 15x80; 1x TX 20x100;		
		1x TX 25x100; 1x TX 30x115; 1x TX 40x130		

334/368/6 螺丝刀组套 · 带刀架



Code		EAN		
05347778001		4013288	122735	1
		350 PH		
		1x PH 1x80; 1x PH 2x100		
		334		
		1x 1,2x6,5x150		
		335		
		1x 0,8x4,0x100		
		368		
		1x # 1x80; 1x # 2x100		

367/6 Kraftform Plus TORX® B0 螺丝刀组套 · 带刀架

- TORX®防盗梅花螺丝用螺丝刀

367/6 Kraftform Plus TORX® B0 螺丝刀组套 · 带刀架



Code		EAN		1
05138250001		4013288		
028907				
		367 TORX® B0 1x TX 10x80; 1x TX 15x80; 1x TX 20x100; 1x TX 25x100; 1x TX 30x115; 1x TX 40x130		

338/2 接线盒驱动工具组套 (弹簧笼)

带 2 个弹簧端子驱动工具的组套。使用弯曲刀杆可以轻松操作直刀杆无法触及的配电箱弹簧端子。

刀柄可放置在接线盒内, 这样可以方便使用双手安插电线。

Kraftform 多重材料手柄, 可快速拆装螺丝, 降低疲劳。

- 用于电气线路端子中解锁触点的特殊工具
- 由于采用了曲线几何结构, 因此可以操作普通螺丝刀无法触及的接线盒
- 适用于导体横截面最高为 1.5 mm² 和 2.5 至 4.0 mm² 的弹簧端子

338/2 接线盒驱动工具组套 (弹簧笼)



Code		EAN		1
05008100001		4013288		
225658				
		338 1x 0,4x2,5x81; 1x 0,6x3,5x81		

395 H0/7 SM 螺母螺丝刀组套

- 螺母螺丝刀, 用于六角头螺丝
- 空心刀杆适用于长螺杆, 镀铬

395 H0/7 SM 螺母螺丝刀组套



Code		EAN		1
05029510001		4013288		
111432				
		395 H0 1x 5,0x90; 1x 5,5x90; 1x 6,0x90; 1x 7,0x90; 1x 8,0x90; 1x 10,0x90; 1x 13,0x90		

395 H0/3 螺母螺丝刀组套

- 应用: 用于六角头螺栓、螺丝和螺帽
- 维拉螺帽螺丝刀带空心刀杆是冷暖水槽安装时您的最佳伙伴

395 H0/3 螺母螺丝刀组套



Code		EAN		1
05134275001		4013288		
207616				
		395 H0 1x 10,0x90; 1x 13,0x90; 1x 7/16"x90		

391/3 套筒扳手螺丝刀套装

- 圆形柔性杆

391/3 套筒扳手螺丝刀套装



Code		EAN		
05135311001		4013288		
		169860		
		391		
		1x 6x167; 1x 7x167; 1x 8x167		

Stubby 套 1 螺丝刀套装

适宜于狭小空间的短杆小螺丝刀。双重材料手柄有硬质和软质区，确保牢固握抓并精确作业。刀杆全方位体现维拉工艺技术的优势。

刀杆表面经特殊处理，具有良好抗腐蚀性和精度。六角防滑保护有效防止了操作时打滑的危险。

- 小巧设计适合狭小空间内作业
- 符合人体工程学的双重材料 Kraftform 手柄提升作业精确度
- 全方面体现维拉工艺技术优势的刀杆
- 六角防滚动保护，防止螺丝刀的滚动
- “易寻”色标系统：用特定的颜色代表不同端头种类和尺寸

Stubby 套 1 螺丝刀套装

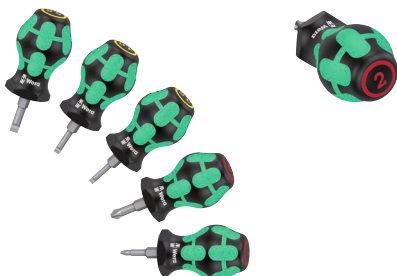

Code		EAN		
05008870001		4013288		
		212337		
		335 Stubby		
		1x 0,6x3,5x24,5; 1x 0,8x4,0x24,5; 1x 1,0x5,5x24,5		
		350 PH Stubby		
		1x PH 1x25; 1x PH 2x25		

Stubby 套 2 螺丝刀套装

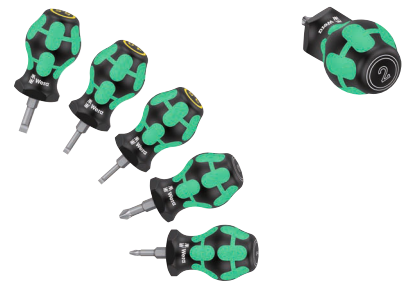

Code		EAN		
05008871001		4013288		
		212344		
		335 Stubby		
		1x 0,6x3,5x24,5; 1x 0,8x4,0x24,5; 1x 1,0x5,5x24,5		
		355 PZ Stubby		
		1x PZ 1x25; 1x PZ 2x25		

Stubby 套 3 螺丝刀套装

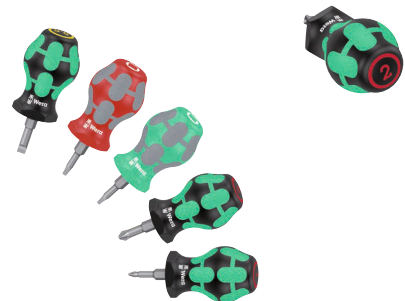

Code		EAN		
05008872001		4013288		
		214096		
		350 PH Stubby		
		1x PH 1x25; 1x PH 2x25		
		335 Stubby		
		1x 1,0x5,5x24,5		
		368 Stubby		
		1x # 01x25; 1x # 02x25		

Stubby 套装 TX 1 螺丝刀套装 TORX®

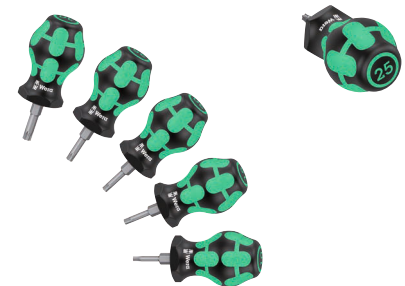

Code		EAN		
05008876001		4013288		
		212351		
		367 TORX® Stubby		
		1x TX 10x25; 1x TX 15x25; 1x TX 20x25; 1x TX 25x25; 1x TX 30x25		

自行车大背包 1

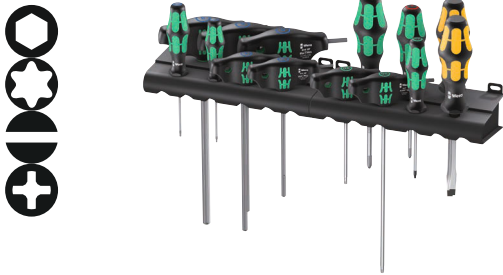

Code	EAN		
05004190001	220745		1
		354 Hex-Plus 1x 2,0x75; 1x 2,5x75	
		454 HF 1x 3x100; 1x 4x150; 1x 5x150; 1x 6x200; 1x 8x200	
		367 TORX® 1x TX 10x80	
		467 TORX® HF 1x TX 20x100; 1x TX 25x200	
		932 A 1x 1,0x5,5x100; 1x 1,2x7,0x125	
		350 PH 1x PH 1x80; 1x PH 2x100	

1267 A TORX® 梅花板式螺丝刀

应用: 用于TORX®梅花螺丝

刀身: 圆形

设计: 镭射表面处理

手柄: 多重材料手柄

- TORX®旗柄螺丝刀, 用于TORX®梅花螺丝
- 多重材料手柄
- 圆形刀片采用BlackLaser激光发黑处理, 具有出色的表面保护和较长使用寿命
- 具有抗腐蚀性
- 可为小螺丝传递较高扭矩

1267 A TORX® 梅花板式螺丝刀



Code	EAN						
05026350001	093516				mm	mm	mm
05026351001	093523				mm	mm	mm
05026352001	093530				mm	mm	mm
05026353001	093547				mm	mm	mm
05026354001	093554				mm	mm	mm

1267 A TORX PLUS® 增强型梅花板式螺丝刀



Code	EAN						
05026360001	093561				mm	mm	mm
05026361001	093578				mm	mm	mm
05026363001	093608				mm	mm	mm

1267 B TORX® 梅花和内六角两用板式螺丝刀

应用: 用于TORX®梅花和内六角螺丝

刀身: 六角形

设计: TORX®梅花形和六角形, 镭射表面处理

手柄: 多重材料手柄

1267 B TORX® 梅花和内六角两用板式螺丝刀



Code	EAN						
05026372001	093639				mm	mm	mm
05026373001	093707				mm	mm	mm
05026374001	093646				mm	mm	mm

1267 B TORX PLUS® 增强型梅花和内六角两用板式螺丝刀



Code	EAN						
05026382001	093677				mm	mm	mm

9500 充/消磁装置 SB

维拉加消磁器对工具进行加磁和消磁，确保螺丝牢牢贴在刀杆上。

- 充磁和消磁工具头
- 要充磁，沿正极移动刀具头
- 要消磁，沿负极移动刀具头

9500 充/消磁装置 SB



	EAN							
Code	4013288	mm						
05033404001	219589	64,6						1

1427 锥子



	EAN							
Code	4013288	mm	mm					
05027405001	019998	105	92	4 3/16"				5

1428 扩孔锥



	EAN							
Code		mm	mm					
05027455001	020000	107	92	4 9/32"				5

9611 磁性条带 · 最多可用于 9 个 Kraftform 螺丝刀 · 空袋

- 条形端头完全固定住工具
- 凭借其强大的磁性，该条可以牢牢地吸附在金属表面。条带也可以用螺栓固定在墙上

9611 磁性条带 · 最多可用于 9 个 Kraftform 螺丝刀 · 空袋



	EAN							
Code	4013288	mm	mm					
05136414001	230690	30,0	400,0					1

Kraftform 螺丝刀架



Code		mm	mm					
05134002001	100047	190,0	80					1

Kraftform 精密螺丝刀架



	EAN							
Code	4013288	mm	mm					
05134001001	100030	190,0	50,0					1

1440/1442 螺丝夹持器组套

应用: 带固持功能, 可将所有外形和尺寸的螺丝牢固夹持在工具上, 适用于直径为4.5-6.0mm和6.0-8.5mm的圆形和六角形刀杆

结构: 高弹性

- 螺丝夹持器组套
- 工具配件, 带螺丝固持功能
- 可将任意形状和尺寸的螺丝夹持在工具上
- 坚固的高弹性材料制成

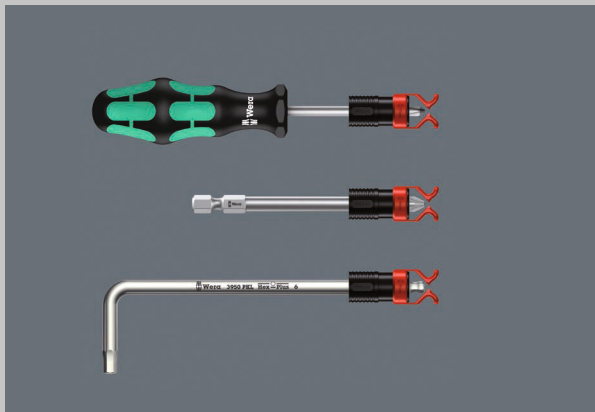

1441 螺丝夹持器, 用于螺丝刀杆、长批头和L型扳手, 带螺丝固持功能



	EAN	∅	h							
Code	4013288	mm	mm							
05073681001	140357	4,5-6,0	41,0							1

1440/1442 螺丝夹持器组套



	EAN									
Code	4013288									
05073680001	140340									1
				1440						
				1x 4,5-6,0x41,0						
				1442						
				1x 6,0-8,5x41,0						

用于 MC4 太阳能连接器的 9108/2 PV 安装工具组套

由 2 个 MC4 太阳能连接器 (多触点) 安装工具组成的组套。

- 2 个用于 MC4 太阳能连接器 (多触点) 的 9108 安装工具
- 用于连接和断开 MC4 连接器
- 玻璃纤维增强塑料

用于 MC4 太阳能连接器的 9108/2 PV 安装工具组套



Code	EAN			
	4013288			
05136700001	230461			1
		9108		
		2x 115		

9523 链条铆接机配件包

- 带有链条铆接机和链条紧固件, 带有可更换的铆钉销, 用于打开和关闭自行车链条。适用于单速链条, 最高可达12速

9523 链条铆接机配件包

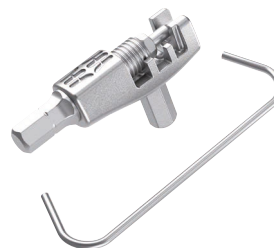

Code	EAN			
	4013288			
05136039001	227867			1
		9513 Chain 工具		
		9512 Chain-Hook		

自行车组套 13

2 件轮胎千斤顶组套, 用于移动和固定应用。

2 件轮胎千斤顶均以玻璃纤维强化塑料制成: 9502 轮胎千斤顶, 配接头, 也适合固定法式阀门和 9503 配顶出阀的轮胎千斤顶。

配玻璃纤维强化塑料轮胎千斤顶, 轮胎可以安全脱离轮辋而不损坏轮辋。

- 2 件轮胎千斤顶 (9502+9503) 均以玻璃纤维强化塑料制成
- 轮胎可以安全脱离轮辋而不损坏轮辋
- 9502 轮胎千斤顶的 $\frac{1}{4}$ " 六角支驱动可以固定法式阀门, 使用 $\frac{1}{4}$ " 批头
- 9503 轮胎千斤顶, 配顶出阀, 便于放气

自行车组套 13



Code	EAN		
	4013288		
05004184001	220585	9502 1x 105,0	5
		9503 1x 105,0	

自行车组套 15

超小型轻型摩托车工具, 配备两台四轮驱动批头和三台轮胎千斤顶。四种不同的螺丝型材只能用一个批头操作。显著降低重量50%以上。

由于节省了大量空间, 自行车组套 15 完美无缺, 可供移动使用。小尖头的弹簧压缩使大型材具有可操作性。批头有一个 $\frac{1}{4}$ " 的六角形驱动 (Wera 连接系列 1), 也可以与批头棘轮和带有 Rapidaptor 的插换式螺丝刀一起使用。9504 轮胎千斤顶有一个 $\frac{1}{4}$ " 的安装架, 用于使用 $\frac{1}{4}$ " 的批头。

当两个 9504 轮胎千斤顶堆放在一起时, 可以插入一个 4 合 1 的批头, 然后使用螺丝刀。9505 轮胎千斤顶, 配顶出阀和放气阀。千斤顶和 4 合 1 批头可以夹在一起, 这样一切都很紧凑, 不会丢失任何东西。

自行车组套 15



Code	EAN		
	4013288		
05004182001	222190	9504 2x 105,0	1
		9505 1x 105,0	
		9506 1x 3,0; 4,0; 5,0; 6,0x37	
		9507 1x 2,5; 5,0; 6,0; TX 25x37	

Kraftform Micro – 电子设备技师使用的高级螺丝刀

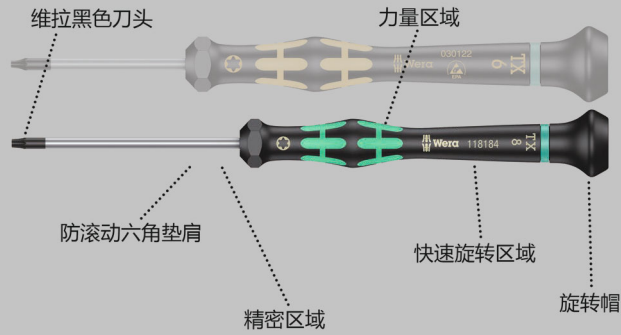

由多种材料组成的螺丝刀手柄可以更人性化的进行作业。带三个功能区和特殊布局的Kraftform精密螺丝刀可达到这种要求。自由旋转螺帽为手部提供了支撑力，可快速精确地工作。在精调作业时，刀杆正上方的精密区域让用户可以很轻松地旋转到正确的转动角度。

刀头端附近的力量区域融合了软质材料，确保松开或紧固螺丝的高扭力传输，防止螺丝刀滑出螺丝。自由旋转螺帽下面的快速旋转区域使螺丝刀可快速转动。经过精制硬化处理的维拉黑色刀头，不但可更深入吻合，更具有防腐蚀和较长的使用寿命。

“Take it easy” 工具易寻色标系统：通过彩色标识，辨别螺丝刀头类型与大小。让用户更快的在工具包中找到自己所需要的工具。

- Kraftform多重材料精密手柄，符合人体工程学，可快速拆装螺丝
- 带防滚动保护和旋转帽用于快速旋转
- 维拉黑色刀头，可精确配合，具有最佳的抗腐蚀性
- “易寻”色标系统：用特定的颜色代表不同端头种类和尺寸
- 可供电子工程师，眼镜调配师，精密机械师，珠宝商或IT硬件工程师使用

2035 一字螺丝刀 · 适用于电子应用

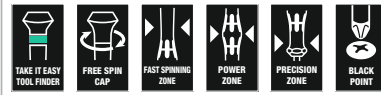

	EAN	刀头	刀身	刀柄	刀柄直径	刀柄长度	刀柄直径	刀柄长度
Code	4013288	mm	mm	mm	mm	mm		
05117990001	108418	0,16	0,8	40	97	2,0	1/32"	10
05117991001	108425	0,18	1,0	40	97	2,0	0,04"	10
05117992001	108432	0,20	1,2	40	97	2,0	0,05"	10
05118002001	031877	0,23	1,5	40	97	2,0	1/16"	10
05118003001	108456	0,23	1,5	60	97	2,0	1/16"	10
05118000001	031860	0,25	1,2	40	97	2,0	0,05"	10
05117993001	108463	0,30	1,8	40	97	2,0	0,07"	10
05118004001	031884	0,30	1,8	60	97	2,0	0,07"	10
05118017001	151704	0,30	2,0	50	97	2,0"	5/64"	10
05117997001	194824	0,35	2,5	40	97	2,5	3/32"	10
05118005001	108470	0,40	2,0	40	97	2,5	5/64"	10
05118006001	031891	0,40	2,0	60	97	2,5	5/64"	10
05118007001	108487	0,40	2,0	100	97	2,5	5/64"	10
05117994001	108494	0,40	2,5	50	97	2,5	3/32"	10
05118008001	031907	0,40	2,5	80	97	2,5	3/32"	10
05117995001	108517	0,50	3,0	50	97	3,0	1/8"	10
05118010001	031914	0,50	3,0	80	97	3,0	1/8"	10
05118012001	031921	0,60	3,5	80	97	4,0	9/64"	10
05118014001	031938	0,80	4,0	80	97	4,0	5/32"	10

2055 PZ 米字螺丝刀 · 适用于电子应用



	EAN	刀头	刀身	刀柄	刀柄直径	刀柄长度	刀柄直径	刀柄长度
Code	4013288		mm	mm	mm			
05118030001	032195	PZ 0	60	97	3,0	2 3/8"		10
05118032001	032201	PZ 1	80	97	4,0	3 1/16"		10

2050 PH 十字螺丝刀 · 适用于电子应用



	EAN	+	⌀	ℓ	ℓ	ℓ	ℓ	
Code	4013288		mm	mm	mm	mm		
05345290001 ¹⁾²⁾	164506	PH 000	40	97	1,5/2,5	1 9/16"		10
05118019001 ¹⁾²⁾	108562	PH 00	40	97	1,8/2,5	1 9/16"		10
05118020001 ¹⁾	031969	PH 00	60	97	2,5	2 3/8"		10
05118026001 ³⁾	194800	PH 0	40	97	3,0	1 9/16"		10
05118022001 ³⁾	031976	PH 0	60	97	3,0	2 3/8"		10
05118023001	108579	PH 1	60	97	4,0	2 3/8"		10
05118024001	031983	PH 1	80	97	4,0	3 1/8"		10

¹⁾ 专为亚洲的十字PH螺丝优化

²⁾ 刀头的标称长度为10 mm.

³⁾ 尺寸0根据JIS 0 (日本相机工业标准) 修改

2067 TORX® HF 梅花螺丝刀 · 带固持功能 · 适用于电子应用

- TORX®梅花螺丝固持功能

2067 TORX® HF 梅花螺丝刀 · 带固持功能 · 适用于电子应用



	EAN	T	⌀	ℓ	ℓ	ℓ	ℓ	
Code	4013288		mm	mm	mm	mm		
05118180001	108623	TX 4	40	97	2,5	1 9/16"		5
05118181001	108630	TX 5	40	97	3,0	1 9/16"		5
05118182001	108647	TX 6	40	97	3,0	1 9/16"		5
05118183001	108654	TX 7	60	97	3,0	2 3/8"		5
05118184001	108661	TX 8	60	97	3,0	2 3/8"		5
05118185001	108678	TX 9	60	97	4,0	2 3/8"		5
05118186001	108685	TX 10	60	97	4,0	2 3/8"		5

2067 TORX® 梅花螺丝刀 · 适用于电子应用



	EAN	T	⌀	ℓ	ℓ	ℓ	ℓ	
Code	4013288		mm	mm	mm	mm		
05118035001	108593	TX 1	40	97	2,0	1 9/16"		5
05118036001	108609	TX 2	40	97	2,0	1 9/16"		5
05118037001	108616	TX 3	40	97	2,0	1 9/16"		5
05118039001	040084	TX 4	40	97	2,5	1 9/16"		5
05118040001	032218	TX 5	40	97	3,0	1 9/16"		5
05118042001	032225	TX 6	40	97	3,0	1 9/16"		5

2067 TORX® BO 防盗梅花螺丝刀 · 适用于电子应用



	EAN	T	⌀	ℓ	ℓ	ℓ	ℓ	
Code	4013288		mm	mm	mm	mm		
05118044001	032232	TX 7	60	97	3,0	2 3/8"		5
05118046001	032249	TX 8	60	97	3,0	2 3/8"		5
05118048001	032256	TX 9	60	97	4,0	2 3/8"		5
05118050001	032263	TX 10	60	97	4,0	2 3/8"		5
05118052001	032270	TX 15	60	97	4,0	2 3/8"		5
05118054001	032287	TX 20	60	97	4,0	2 3/8"		5

2067 五星螺丝刀 · 适用于电子应用



	EAN	T	⌀	ℓ	ℓ	ℓ	ℓ	
Code	4013288		mm	mm	mm	mm		
05030160001	178749	1 IPR	40	97	2,0	1 37/64"		5

¹⁾ 无球头

增强型内六角- 专门针对六角型螺丝的设计

如图可看到和螺槽的接触面积大幅度的增加 因此减少了
转位时各个面所承受的压力 从而避免破坏螺丝凹槽的轮廓

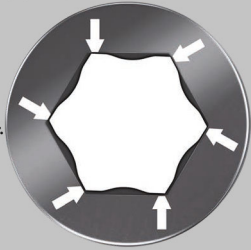

- Kraftform精密螺丝刀, 用于内六角螺丝
- Hex-Plus六角增强型可延长螺丝头的寿命

2054 内六角螺丝刀 · 适用于电子应用

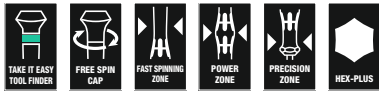

Code	EAN	六角	六角	柄长	柄径	柄径	柄径	柄径
Code	4013288	mm	mm	mm	mm	mm	mm	mm
05118060001	032072	0,7		40	97	3,0	1 9/16"	5
05118062001	032089	0,9		40	97	3,0	1 9/16"	5
05118064001	032096	1,3		40	97	3,0	1 9/16"	5
05118066001	032102	1,5		60	97	3,0	2 3/8"	5
05118068001	032119	2		60	97	3,0	2 3/8"	5
05118070001	032126	2,5		60	97	4,0	2 3/8"	5
05118072001	032133	3,0		60	97	4,0	2 3/8"	5
05345284001	152206	-	0,028"	40	97	3,0	1 9/16"	5
05345285001	152213	-	0,035"	40	97	3,0	1 9/16"	5
05118074001	032140	-	0,05"	40	97	3,0	1 9/16"	5
05118076001	032157	-	1/16"	60	97	3,0	2 3/8"	5
05118078001	032164	-	5/64"	60	97	3,0	2 3/8"	5
05118080001	032171	-	3/32"	60	97	4,0	2 3/8"	5
05118082001	032188	-	7/64"	60	97	4,0	2 3/8"	5
05118075001	108807	-	1/8"	60	97	4,0	2 3/8"	5

2052 六角球头螺丝刀 · 适用于电子应用

- 带球头, 可在狭小空间内进行安装作业

2052 六角球头螺丝刀 · 适用于电子应用

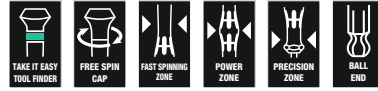

Code	EAN	六角	六角	柄长	柄径	柄径	柄径	柄径
Code	4013288	mm	mm	mm	mm	mm	mm	mm
05118089001	108814	1,3		60	97	3,0	2 3/8"	5
05118090001	031990	1,5		60	97	3,0	2 3/8"	5
05118092001	032003	2,0		60	97	3,0	2 3/8"	5
05118094001	032010	2,5		60	97	4,0	2 3/8"	5
05118096001	032027	3,0		60	97	4,0	2 3/8"	5
05118098001	032034	-	1/16"	60	97	3,0	2 3/8"	5
05118100001	032041	-	5/64"	60	97	3,0	2 3/8"	5
05118102001	032058	-	3/32"	60	97	3,0	2 3/8"	5
05118106001	110954	-	7/64"	60	97	4,0	2 3/8"	5
05118103001	108821	-	1/8"	60	97	4,0	2 3/8"	5

2072 Kraftform 精密Microstix® 三叶螺丝刀

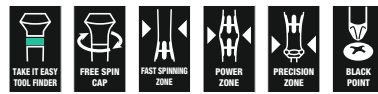

Code	EAN	三叶	柄长	柄径	柄径	柄径	柄径	柄径
Code	194817	m	40	97	2,5	1 9/16"		5
05118145001	194817	m	40	97	2,5	1 9/16"		5

2069 螺帽螺丝刀 · 适用于电子应用



	EAN							
Code	4013288	mm		mm	mm	mm		
05118108001	108852	1,5		60	97	5,7	2 3/8"	5
05118109001	108869	1,8		60	97	5,7	2 3/8"	5
05118110001	032300	2,0		60	97	5,7	2 3/8"	5
05118112001	032317	2,5		60	97	5,7	2 3/8"	5
05118114001	032324	3,0		60	97	5,7	2 3/8"	5
05118116001	032331	3,2		60	97	5,7	2 3/8"	5
05118118001	032348	3,5		60	97	5,7	2 3/8"	5
05118120001	032355	4,0		60	97	5,7	2 3/8"	5
05118122001	032362	4,5		60	97	6,4	2 3/8"	5
05118124001	032379	5,0		60	97	7,0	2 3/8"	5
05118126001	032386	5,5		60	97	7,8	2 3/8"	5
05345281001	150189	6,0		60	97	8,5	2 3/8"	5
05118128001	032393	-	3/32"	60	97	5,7	2 3/8"	5
05118130001	032409	-	7/64"	60	97	5,7	2 3/8"	5
05118132001	032416	-	1/8"	60	97	5,7	2 3/8"	5
05118134001	032423	-	9/64"	60	97	5,7	2 3/8"	5
05118136001	032430	-	5/32"	60	97	5,7	2 3/8"	5
05118135001	110596	-	3/16"	60	97	6,6	2 3/8"	5
05118137001	112019	-	7/32"	60	97	7,8	2 3/8"	5
05345282001	150196	-	1/4"	60	97	9,0	2 3/8"	5

1429 芯片起子

- 芯片起子用于脱焊后起出电路板上牢固安装的零件

1429 芯片起子



	EAN						
Code	4013288	mm	mm	mm	mm		
05027456001	112187	1,0	3,5	50	97		10

1013 Kraftform 精密 螺丝刀杆

具有可适配半月驱动和HIOS双耳驱动批头的接头。由多种材料组成的螺丝刀手柄可以更人性化的进行作业。

带三个功能区和特殊布局的Kraftform精密螺丝刀可达到这种要求。

自由旋转螺帽为手部提供了支撑力,可快速精确地工作。

对于电子设备技师、光学仪器商、精密仪器工程师、珠宝商、EDP硬件装配工和模型设计师等很多行业的用户来说,这是不可或缺的产品。

- Kraftform精密批头接杆
- Kraftform多重材料精密手柄,带防滚动保护和旋转帽
- 用于4mm半月驱动的批头夹具和4mm HIOS驱动的批头
- 可用于手机、移动电话、照相机及其他电子设备

1013 Kraftform 精密 螺丝刀杆

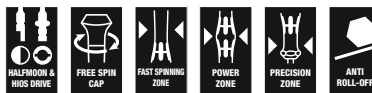

	EAN					
Code	4013288	mm	mm			
05051276001	183699	23	97	29/32"		1

Kraftform 通用精密电子组套 Micro Big Pack 1

Wera Micro螺丝刀组件用于精密机械螺丝连接。

通过支撑旋转帽上的手指, 以及旋转帽下方的快速旋转区, 可以更快速灵活的旋拧操作。

无需进行耗费时间的手动切换。

采用坚固耐用的工具袋进行存放和运输, 工具随时可用。“易寻”色标系统, 可轻松找到所需尺寸。

- 25件装 Kraftform Micro螺丝刀组件, 经久耐用和设计紧凑的可卷式工具袋
- Kraftform精密手柄, 符合人体工程学, 可快速作业
- 工具带防滚动保护, 配备旋转帽用于快速旋转
- 维拉黑色刀头, 可精确配合, 具有最佳的抗腐蚀性
- “易寻”色标系统: 用特定的颜色代表不同端头种类和尺寸
- 适用于电工、光学技术人员、精密机械技术人员、珠宝商或计算机硬件工程师。

Kraftform 通用精密电子组套 Micro Big Pack 1



Code	EAN		
0513400001	4013288 209580		1
		2050 PH Micro 1x PH 000x40 ¹⁾ 2); 1x PH 00x40 ¹⁾ 2); 1x PH 0x40 ³⁾	
		2067 TORX® 1x TX 5x40; 1x TX 6x40	
		2067 TORX® HF 1x TX 5x40; 1x TX 6x40; 1x TX 7x60; 1x TX 8x60; 1x TX 10x60	
		2067 TORX PLUS® IPR Micro 1x 1 IPRx40	
		2054 Micro 1x 0,9x40; 1x 1,3x40; 1x 1,5x60; 1x 2x60	
		2035 Micro 1x 0,23x1,5x40; 1x 0,30x1,8x60; 1x 0,35x2,5x40; 1x 0,40x2,0x60; 1x 0,50x3,0x80	
		2069 Micro 1x 4,0x60; 1x 5,5x60	
		2072 1x mx40	
		1429 1x 1,0x3,5x50	
		K240 1x 50,0x240,0	

¹⁾ 专为亚洲的十字PH螺丝优化

²⁾ 刀头的标称长度为10 mm。

³⁾ 尺寸0根据JCS 0 (日本相机工业标准) 修改

Kraftform 通用精密电子组套/ 12 Universal 1

- Kraftform精密螺丝刀组套, 坚固的帆布包装

Kraftform 通用精密电子组套/ 12 Universal 1

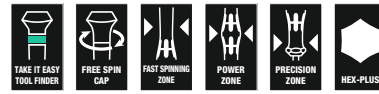

Code	EAN		
05073675001	4013288 165695		1
		2050 PH Micro 1x PH 00x60 ¹⁾ ; 1x PH 0x60 ²⁾	
		2067 TORX® HF 1x TX 5x40; 1x TX 6x40	
		2035 Micro 1x 0,23x1,5x40; 1x 0,30x1,8x60; 1x 0,40x2,0x60; 1x 0,40x2,5x80; 1x 0,50x3,0x80	
		2054 Micro 1x 0,9x40; 1x 1,5x60; 1x 2x60	

¹⁾ 专为亚洲的十字PH螺丝优化

²⁾ 尺寸0根据JCS 0 (日本相机工业标准) 修改

Kraftform 精密螺丝刀组套/12 Electronics 1

- 用于一字、Phillips-十字、TORX® B0 梅花防盗, Hex-六角, IPR- 增强型梅花防盗以及带联轴节Microstix® 三叶螺丝的 Kraftform Micro螺丝刀。

Kraftform 精密螺丝刀组套/12 Electronics 1



Code	EAN		
05073677001	194831		1
		2050 PH Micro 1x PH 000x40 ^{1) 2)} ; 1x PH 00x40 ^{1) 2)} ; 1x PH 0x40 ³⁾	
		2067 TORX® B0 Micro 1x TX 8x60; 1x TX 10x60	
		2067 TORX PLUS® IPR Micro 1x 1 IPRx40	
		2035 Micro 1x 0,23x1,5x40; 1x 0,35x2,5x40	
		2069 Micro 1x 2,5x60; 1x 3,0x60	
		2072 1x mx40	
		1429 1x 1,0x3,5x50	

¹⁾ 专为亚洲的十字PH螺丝优化

²⁾ 刀头的标称长度为10 mm。

³⁾ 尺寸0根据JCS 0 (日本相机工业标准) 修改

Kraftform 精密螺丝刀组套/11 Electronics 1

Kraftform Kompakt Micro Set, 用于精密行业的应用。

适用于4mm半月驱动批头 (Wera系列9) 及4mm HIOS驱动批头 (Wera系列21) 的快速拆装; 手柄/可互换批头, 让更换批头更便捷; Kraftform微型手柄, 具有旋盖和快速转动区, 用于加速转动; 及无耗时地重新定位手柄; 动力区域由软部件整体制成, 用于传送更高的拧松/拧紧扭矩; 直接位于批头上方的精确区域, 在进行调节作业时可纠正旋转角; 10个批头, 用于手动和动力工具; 只需简单的将批头推入插口内就可以快速连接批头; 自锁定装置, 确保安全; 更换批头时, 只需简单地向上推套接口, 然后拆下批头; 自由旋转的套接口, 在拧紧螺钉作业期间可以简单地使用工具。

Kraftform 精密螺丝刀组套/11 Electronics 1

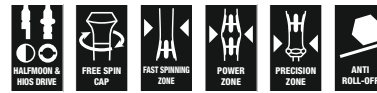

Code	EAN		
05073676001	194848		1
		1013 Kraftform Micro 1x 97	
		851/9 C 1x PH 000x44 ¹⁾ ; 1x PH 00x44 ¹⁾ ; 1x PH 0x44 ²⁾	
		867/9 C TORX® 1x TX 8x44	
		867/9 C TORX PLUS® 1x 3 IPx44	
		867/9 IPR TORX® PLUS 1x 1 IPRx44	
		800/9 C 1x 0,35x2,5x44	
		872/9 1x mx44	
		869/9 1x 2,5x44,0; 1x 3,0x44,0	

¹⁾ 专为亚洲的十字PH螺丝优化

²⁾ 尺寸0根据JCS 0 (日本相机工业标准) 修改

Kraftform 精密螺丝刀组套Micro 11 Universal 1

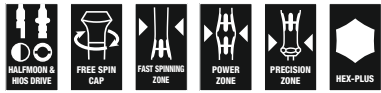

Code	EAN		
05135938001	4013288 178343		1
		1013 Kraftform Micro 1x 97	
		851/9 C 1x PH 00x44 ¹⁾ ; 1x PH 0x44 ²⁾ ; 1x PH 1x44 ¹⁾	
		840/9 C 1x 1,5x44; 1x 2,0x44	
		800/9 C 1x 0,23x1,5x44; 1x 0,40x2,0x44; 1x 0,50x3,0x44	
		867/9 C TORX® 1x TX 5x44; 1x TX 6x44	

¹⁾ 专为亚洲的十字PH螺丝优化

²⁾ 尺寸0根据JCS 0 (日本相机工业标准) 修改

2035/6 A 螺丝刀组套 · 带刀架 · 适用于电子应用

- 实用塑料刀架

2035/6 A 螺丝刀组套 · 带刀架 · 适用于电子应用



Code	EAN		
05118150001	4013288 031945		1
		2050 PH Micro 1x PH 00x60 ¹⁾ ; 1x PH 0x60 ²⁾	
		2035 Micro 1x 0,30x1,8x60; 1x 0,40x2,0x60; 1x 0,40x2,5x80; 1x 0,50x3,0x80	

¹⁾ 专为亚洲的十字PH螺丝优化

²⁾ 尺寸0根据JCS 0 (日本相机工业标准) 修改

2035/6 B 螺丝刀组套 · 带刀架 · 适用于电子应用

- 实用塑料刀架

2035/6 B 螺丝刀组套 · 带刀架 · 适用于电子应用

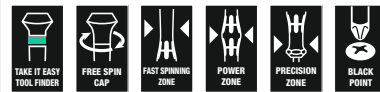

Code	EAN		
05118152001	4013288 031952		1
		2050 PH Micro 1x PH 0x60 ¹⁾ ; 1x PH 1x80	
		2035 Micro 1x 0,40x2,5x80; 1x 0,50x3,0x80; 1x 0,60x3,5x80; 1x 0,80x4,0x80	

¹⁾ 尺寸0根据JCS 0 (日本相机工业标准) 修改

2050/6 螺丝刀组套 · 带刀架 · 适用于电子应用

- 用于一字、Phillips-十字螺丝, IPR-增强型梅花防盗和 Microstix® 三叶螺丝的 Kraftform Micro螺丝刀
- 实用塑料刀架

2050/6 螺丝刀组套 · 带刀架 · 适用于电子应用

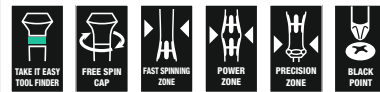

Code	EAN		
05030181001	4013288 194794		1
		2050 PH Micro 1x PH 000x40 ¹⁾ ²⁾ ; 1x PH 00x40 ¹⁾ ²⁾ ; 1x PH 0x40 ³⁾	
		2067 TORX PLUS® IPR Micro 1x 1 IPRx40	
		2072 1x mx40	
		2035 Micro 1x 0,35x2,5x40	

¹⁾ 专为亚洲的十字PH螺丝优化

²⁾ 刀头的标称长度为10 mm.

³⁾ 尺寸0根据JCS 0 (日本相机工业标准) 修改

2052/6 六角螺丝刀组套 · 带刀架 · 适用于电子应用

- Kraftform精密螺丝刀, 用于内六角螺丝, 带球头

2052/6 六角螺丝刀组套 · 带刀架 · 适用于电子应用



	Code	EAN		
	05118156001	032065		1
			<ul style="list-style-type: none"> ○ 2052 Micro 1x 1,5x60; 1x 2,0x60; 1x 2,5x60; 1x 3,0x60 ○ 2054 Micro 1x 0,9x40; 1x 1,3x40 	

2067/6 TORX® B0 螺丝刀组套 · 带刀架 · 适用于电子应用

- Kraftform精密螺丝刀组套, 用于TORX®防盗梅花螺丝

2067/6 TORX® B0 螺丝刀组套 · 带刀架 · 适用于电子应用



	Code	EAN		
	05118154001	032294		1
			<ul style="list-style-type: none"> ♻️ 2067 TORX® B0 Micro 1x TX 7x60; 1x TX 8x60; 1x TX 9x60; 1x TX 10x60; 1x TX 15x60; 1x TX 20x60 	

2069/6 螺丝刀组套 · 带刀架 · 适用于电子应用

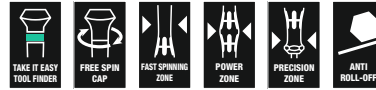

	Code	EAN		
	05118158001	032447		1
			<ul style="list-style-type: none"> ● 2069 Micro 1x 2,0x60; 1x 2,5x60; 1x 3,0x60; 1x 3,5x60; 1x 4,0x60; 1x 5,0x60 	

T 形柄 400 系列

符合人体工学形状的双重材料T型柄, 手指握柄和舒适表面能最有效地传输扭力, 缓解作业疲劳。

表面经过特殊处理的刀杆, 确保了高防腐性和刀头精度。

- T型柄螺丝刀, 确保紧固或松开时高扭力的传输。
- 符合人体工程学的双重材料手柄, 手指握柄和舒适的手感, 能最大程度传输扭力, 缓解作业疲劳。
- “易寻”色标系统: 用特定的颜色代表不同端头种类和尺寸
- 额外延伸的短臂杆, 可借助长臂杆的杠杆作用输出更大扭力

454 T 型柄六角螺丝刀



Code	EAN							
05023330001	207753	2	100	12	32	65	4"	5
05023332001	207814	2,5	100	12	32	65	4"	5

454 HF T型柄六角螺丝刀Hex-Plus · 带固持功能



Code	EAN	六角	柄长	柄宽	柄高	柄厚	包装
Code	EAN	mm	mm	mm	mm	mm	
05023334001	207838	3	100	15	38	77	5
05023338001	207883	4	100	15	38	77	5
05023339001	207876	4	150	15	38	77	5
05023340001	207890	4	200	15	38	77	5
05023342001	207913	5	100	20	49	99	5
05023343001	207920	5	150	20	49	99	5
05023344001	207937	5	200	20	49	99	5
05023346001	207951	6	100	20	49	99	5
05023347001	207968	6	150	20	49	99	5
05023348001	207975	6	200	20	49	99	5
05023350001	208002	7	200	20	49	99	5
05023351001	208019	8	100	20	49	99	5
05023352001	208026	8	150	20	49	99	5
05023353001	208033	8	200	20	49	99	5
05023354001	208057	10	100	20	49	99	5
05023355001	208064	10	200	20	49	99	5

454 T型柄Hex-Plus六角螺丝刀 · 英制



Code	EAN	六角	柄长	柄宽	柄高	柄厚	包装
Code	EAN	mm	mm	mm	mm	mm	
05023356001	214133	5/64"	150	12	32	65	5
05023357001	208071	3/32"	150	12	32	65	5
05023358001	208088	7/64"	150	12	32	65	5

454 HF T型柄六角螺丝刀Hex-Plus · 带固持功能 · 英制

- 长臂杆带固持功能, 让螺丝能牢固附着在工具上

454 HF T型柄六角螺丝刀Hex-Plus · 带固持功能 · 英制



Code	EAN	六角	柄长	柄宽	柄高	柄厚	包装
Code	EAN	mm	mm	mm	mm	mm	
05023359001	208095	1/8"	150	15	38	77	5
05023360001	208101	9/64"	150	15	38	77	5
05023361001	208118	5/32"	150	15	38	77	5
05023362001	208125	3/16"	150	20	49	99	5
05023363001	208132	7/32"	150	20	49	99	5
05023364001	208149	1/4"	150	15	49	99	5
05023365001	208156	5/16"	150	20	49	99	5
05023366001	208163	3/8"	150	20	49	99	5

467 TORX® HF T型柄螺丝刀 · 带固持功能

- 长臂杆带固持功能, 让螺丝能牢固附着在工具上

467 TORX® HF T型柄螺丝刀 · 带固持功能



Code	EAN	六角	柄长	柄宽	柄高	柄厚	包装
Code	EAN	mm	mm	mm	mm	mm	
05023367001	208217	TX 6	100	12	32	65	3,0 5
05023368001	208224	TX 7	100	12	32	65	3,0 5
05023369001	208231	TX 8	100	12	32	65	3,5 5
05023370001	208248	TX 9	100	12	32	65	3,5 5
05023371001	208255	TX 10	100	12	32	65	4,0 5
05023372001	208262	TX 15	100	15	38	77	4,0 5
05023373001	208279	TX 20	100	15	38	77	4,5 5
05023374001	208286	TX 20	200	15	38	77	4,5 5
05023375001	208293	TX 25	100	15	38	77	5,0 5
05023376001	208309	TX 25	200	15	38	77	5,0 5
05023377001	208316	TX 27	200	20	49	99	6,0 5
05023378001	208323	TX 30	200	20	49	99	6,0 5
05023379001	208330	TX 40	200	20	49	99	8,0 5
05023380001	208347	TX 45	200	20	49	99	9,0 5

495 T型柄螺帽螺丝刀

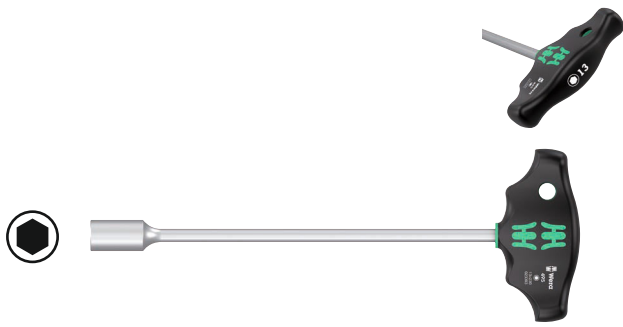

Code	EAN	六角头	长度	柄长	柄宽	柄高	重量	包装
05023381001	208354	5	230	38	77	9"	5	
05023382001	208361	5,5	230	38	77	9"	5	
05023383001	208378	6	230	38	77	9"	5	
05023384001	208385	7	230	49	99	9"	5	
05023385001	208392	8	230	49	99	9"	5	
05023386001	208408	9	230	49	99	9"	5	
05023387001	208415	10	230	49	99	9"	5	
05023389001	208439	11	230	49	99	9"	5	
05023391001	208477	12	230	49	99	9"	5	
05023393001	208491	13	230	49	99	9"	5	

Rapidaptor 快速批头接杆 – 令人惊艳的多功能工具

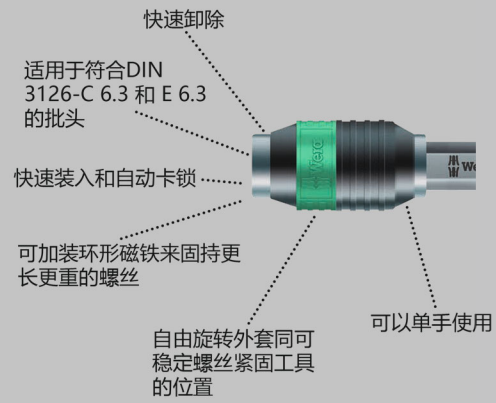

符合人体工学形状的双重材料T型柄，手指握柄和舒适表面能最有效地传输扭力，缓解作业疲劳。

B可用于DIN ISO 1173-C 6,3和E 6,3标准的1/4"六角头驱动批头。Rapidaptor-接头技术可快速换装批头。

- T型柄螺丝刀，确保紧固或松开时高扭力的传输。
- 符合人体工程学的双重材料手柄，手指握柄和舒适的手感，能最大程度传输扭力，缓解作业疲劳。
- Rapidaptor-接头技术可快速换装批头
- 带环形磁铁
- 符合ISO 1173-C 6.3和E 6.3标准的1/4" 外六角驱动批头

416 R T 型柄快速接头



Code	EAN	六角头	长度	柄长	柄宽	柄高	重量	包装
05023404001	214157	1/4"	45	44	99	1 25/32"	2	

具有棘轮功能和 Rapidaptor 快速释放夹持的 416 RA T 型柄插换式螺丝刀

带有细齿的集成棘轮 (80齿/回转角4.5°) 可以在无需重新定位工具的情况下放松和加速螺丝刀的驱动。

棘轮机构完全嵌入到手柄中, 确保了非常轻松舒适的工作。单手操作采用转向杆, 实现可换向舒适。

手柄外形完美贴合手掌, 符合人体工学, 手指舒适贴合圆形下凹握柄。整个手掌贴合手柄, 避免手掌和手柄之间损失摩擦力。

根据 DIN ISO 1173-C 6.3 和 E 6.3 标准, 适合安装 1/4"六角驱动批头的批头固持器。

采用Rapidaptor技术实现超快速更换。

- 细齿集成棘轮保证快速安全工作
- 方便改变顺时针/逆时针方向的转向杆
- 棘轮机构完全嵌入手柄, 方便工作
- 符合人体工程学的双重材料手柄, 手指握柄和舒适的手感, 能最大程度传输扭力, 缓解作业疲劳
- 极高工作速度的快速旋转套筒
- 带快速旋转套筒的快速锁紧螺丝刀, 用于快速更换雷电位和高工作速度
- 符合ISO 1173-C 6.3和E 6.3标准的1/4" 外六角驱动批头

具有棘轮功能和 Rapidaptor 快速释放夹持的 416 RA T 型柄插换式螺丝刀



Code	EAN	1/4"	45	44	99	1 25/32"	2
05023461001	222824	1/4"	45	44	99	1 25/32"	2

具有棘轮功能的 411 A RA T 型柄螺丝刀适配器 · 1/4"

带有细齿的集成棘轮 (80齿/回转角4.5°) 可以在无需重新定位工具的情况下放松和加速螺丝刀的驱动。

棘轮机构完全嵌入到手柄中, 确保了非常轻松舒适的工作。

单手操作采用转向杆, 实现可换向舒适。

手柄外形完美贴合手掌, 符合人体工学, 手指舒适贴合圆形下凹握柄。

整个手掌贴合手柄, 避免手掌和手柄之间损失摩擦力。

带固定锁紧机构的 1/4" 套筒安装架。

- 细齿集成棘轮保证快速安全工作
- 方便改变顺时针/逆时针方向的转向杆
- 棘轮机构完全嵌入手柄, 方便工作
- 符合人体工程学的双重材料手柄, 手指握柄和舒适的手感, 能最大程度传输扭力, 缓解作业疲劳
- 极高工作速度的快速旋转套筒
- 带固定球锁的 1/4" 套筒安装架

具有棘轮功能的 411 A RA T 型柄螺丝刀适配器 · 1/4"

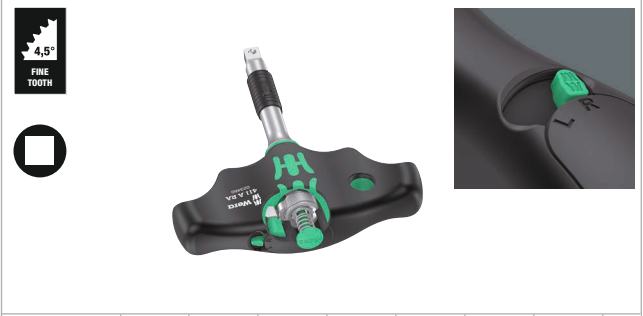

Code	EAN	1/4"	45	44	99	1 25/32"	2
05023460001	222817	1/4"	45	44	99	1 25/32"	2

454/7 HF 套装 1 Hex-Plus T型柄螺丝刀套装 · 带固持功能 · 英制

- 长臂杆带固持功能, 让螺丝能牢固附着在工具上

454/7 HF 套装 1 Hex-Plus T型柄螺丝扳手套装 · 带固持功能

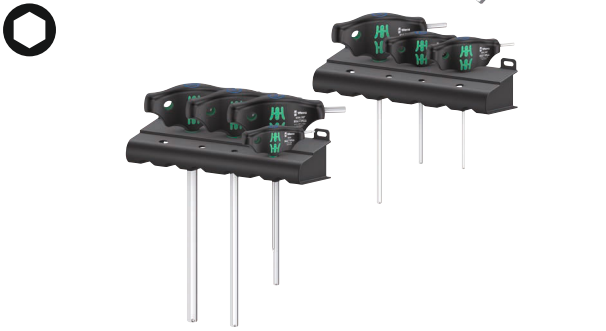

Code	EAN		
05023450001	214829		1
		○ 454 1x 2,5x100	
		○ 454 HF 1x 3x100; 1x 4x100; 1x 5x150; 1x 6x150; 1x 8x200; 1x 10x200	
		Rack 2x 190,0x50,0	

454/7 HF 组套 2 T 型柄螺丝刀组套 · 增强型六角 螺丝刀带固持功能

- T型柄螺丝刀, 确保紧固或松开时高扭力的传输
- 符合人体工程学的双重材料手柄, 手指握柄和舒适的手感, 能最大程度传输扭力, 缓解作业疲劳
- “易寻”色标系统: 用特定的颜色代表不同端头种类和尺寸
- 额外延伸的短臂杆, 可借助长臂杆的杠杆作用输出更大扭力
- 长臂杆带固持功能, 让螺丝能牢固附着在工具上
- 含金属置放架; 置放架可直立放置或悬挂于工具墙

454/7 HF 组套 2 T 型柄螺丝刀组套 · 增强型六角 螺丝刀带固持功能



Code	EAN		
05023453001	221742		1
		○ 454 1x 2,5x100	
		○ 454 HF 1x 3x100; 1x 4x100; 1x 5x150; 1x 6x150; 1x 8x200; 1x 10x200	
		9604 1x 214,0x78,0	

454/10 HF 套装 Imperial 1 Hex-Plus T型柄螺丝刀套装 · 带固持功能 · 英制

- 长臂杆带固持功能, 让螺丝能牢固附着在工具上

454/10 HF 套装 Imperial 1 Hex-Plus T型柄螺丝刀套装 · 带固持功能 · 英制

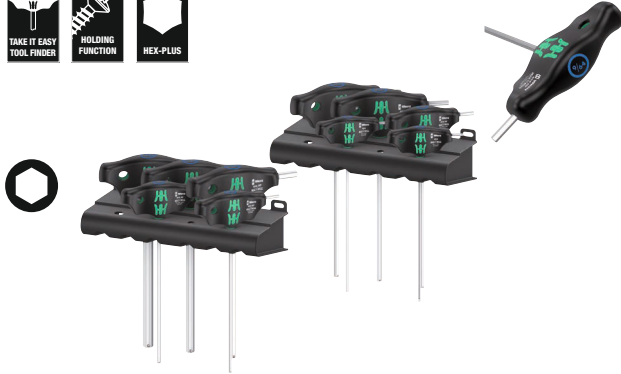

Code		EAN		
		4013288		
05023451001	214836			1
		○	454 Imperial 1x 3/32"x150; 1x 7/64"x150	
		○	454 Imperial HF 1x 1/8"x150; 1x 9/64"x150; 1x 5/32"x150; 1x 3/16"x150; 1x 7/32"x150; 1x 1/4"x150; 1x 5/16"x150; 1x 3/8"x150	
			Rack 2x 190,0x50,0	

454/10 HF 组套 Imperial 2 T型柄螺丝刀组套 · 增强型六角螺丝刀带固持功能 · 英制

T型柄螺丝刀: 容易握持的手柄形状允许传递极高的拧紧和松开扭矩。手柄外形完美贴合手掌, 符合人体工程学, 手指手掌皆能完美贴合握柄曲线。

避免手掌和手柄之间损失摩擦力。

带固持功能, 能够将内六角螺丝稳固夹持在刀头。特殊表面处理提高抗腐蚀性和与螺丝的最优楔合精度。

含金属置放架。置放架可置于工作台或悬挂于工具墙。

- 含金属置放架; 置放架可直立放置或悬挂于工具墙

454/10 HF 组套 Imperial 2 T型柄螺丝刀组套 · 增强型六角螺丝刀带固持功能 · 英制



Code		EAN		
		4013288		
05023454001	221735			1
		○	454 Imperial 1x 3/32"x150; 1x 7/64"x150	
		○	454 Imperial HF 1x 1/8"x150; 1x 9/64"x150; 1x 5/32"x150; 1x 3/16"x150; 1x 7/32"x150; 1x 1/4"x150; 1x 5/16"x150; 1x 3/8"x150	
			9605 1x 214,0x78,0	

454/5 HF SHK 组套 1 T 型柄螺丝刀组套 · Hex-Plus 带固持功能

- 工具组套, 配有 5 把 T 型柄螺丝刀, 可用于管道、供暖和空调操作
- 超长刀杆
- 长臂杆带固持功能, 让螺丝能牢固附着在工具上

454/5 HF SHK 组套 1 T 型柄螺丝刀组套 · Hex-Plus 带固持功能



	Code	EAN		
	05136070001	4013288 228000		1
			454 HF 1x 4x200; 1x 5x200; 1x 6x200; 1x 7x200; 1x 8x200	

467/7 TORX® HF 套装 1 T 型柄 TORX® 螺丝刀套装 · 带固持功能

- 长臂杆带固持功能, 让螺丝能牢固附着在工具上

467/7 TORX® HF 套装 1 T 型柄 TORX® 螺丝刀套装 · 带固持功能

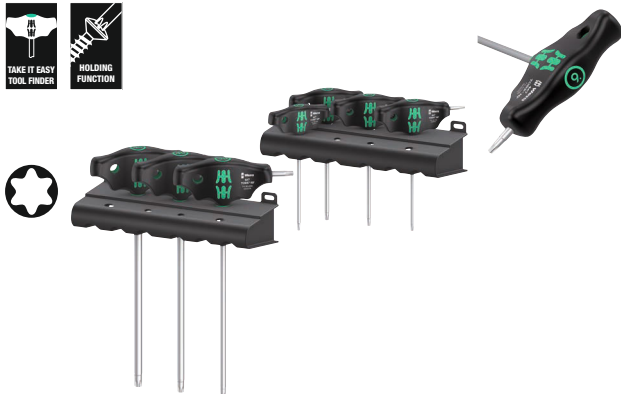

	Code	EAN		
	05023452001	4013288 214874		1
			467 TORX® HF 1x TX 10x100; 1x TX 15x100; 1x TX 20x100; 1x TX 25x100; 1x TX 30x200; 1x TX 40x200; 1x TX 45x200	
			Rack 2x 190,0x50,0	

467/7 TORX® 梅花 HF 组套 2 T 型柄螺丝刀组套 · TORX® 梅花 螺丝刀带固持功能

T 型柄螺丝刀: 优化的手柄形状确保紧固和松开扭矩的传递。

手柄的人体工程学设计使手掌可以完全紧握它, 手指可以支托在半圆形凹槽内。

整个手部与手柄完全接触, 不会产生摩擦损失。

固持功能, 让 TORX® 螺丝牢固附着在工具上。表面经特殊处理, 让刀具有高抗腐蚀性和精度。

含金属置放架。置放架可置于工作台或悬挂于工具墙。

- 含金属置放架; 置放架可直立放置或悬挂于工具墙

467/7 TORX® 梅花 HF 组套 2 T 型柄螺丝刀组套 · TORX® 梅花 螺丝刀带固持功能



	Code	EAN		
	05023456001	4013288 221728		1
			467 TORX® HF 1x TX 10x100; 1x TX 15x100; 1x TX 20x100; 1x TX 25x100; 1x TX 30x200; 1x TX 40x200; 1x TX 45x200	
			9606 1x 214,0x78,0	

自行车组套 6

10 件 T 型柄螺丝刀组套用于自行车作业: 理想的手柄形状允许传递极高的拧紧和松开扭矩。手柄外形完美贴合手掌, 符合人体工程学, 手指舒适贴合圆形下凹握柄。

整个手掌贴合手柄, 避免手掌和手柄之间损失摩擦力。

长臂杆含固持功能, 可将 TORX® 梅花螺丝和内六角螺丝 (从尺寸 3 开始) 稳固固定在工具上。

特殊表面处理具有高度抗腐蚀性和与螺丝的最优拟合精度。超短臂杆可通过长臂杆的杠杆作用传递极高扭矩。

含金属展示架, 便于清晰安排在车间货架上。

- T型柄螺丝刀, 确保紧固或松开时高扭力的传输。
- 长臂杆带固持功能, 让螺丝能牢固附着在工具上。
- 额外延伸的短臂杆, 可借助长臂杆的杠杆作用输出更大扭力
- “易寻”色标系统: 用特定的颜色代表不同端头种类和尺寸

自行车组套 6

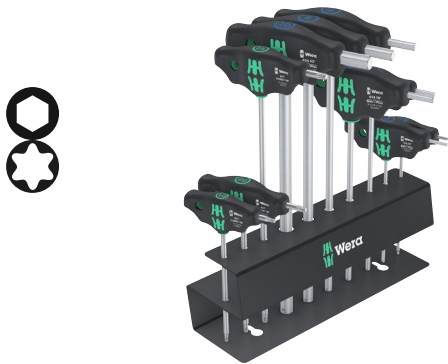

Code	EAN									
05004174001	4013288	220592								1
			○	454	1x 2,5x100					
			○	454 HF	1x 3x100; 1x 4x150; 1x 5x150; 1x 6x200; 1x 8x200; 1x 10x200					
			⊕	467 TORX® HF	1x TX 10x100; 1x TX 20x100; 1x TX 25x200					

9604 T 型柄螺丝刀金属置放架

T 型柄螺丝刀金属置放架。

置放架可置于工作台或悬挂于工具墙。用于至多 7 件 维拉 T 型柄六角套筒螺丝刀。

- T 型柄螺丝刀金属置放架

9604 T 型柄螺丝刀金属置放架



	EAN	←	↓							
Code	4013288	mm	mm							1
05136424001	223418	214,0	78,0							1

9605 T 型柄螺丝刀金属置放架

T 型柄螺丝刀金属置放架。置放架可置于工作台或悬挂于工具墙。用于至多 10 件 维拉 T 型柄六角套筒螺丝刀。

- 用于至多 10 件 T 型柄六角套筒螺丝刀

9605 T 型柄螺丝刀金属置放架



	EAN	←	↓							
Code	4013288	mm	mm							1
05136425001	223425	214,0	78,0							1

9606 T 型柄螺丝刀金属置放架

T 型柄螺丝刀金属置放架。置放架可置于工作台或悬挂于工具墙。用于至多 7 件 维拉 TORX® 梅花 T 型柄螺丝刀。

9606 T 型柄螺丝刀金属置放架



	EAN							
Code	4013288	mm	mm					
05136426001	223432	214,0	78,0					1

ESD 防静电系列

防静电Micro螺丝刀，能有效防止静电和其产生的危害。将手按住旋转盖，旋转盖下面的快速旋转区让螺丝刀快速旋转，节约时间。

一体式软质区保证松开和紧固螺丝高扭力的传输。精确区让用户在精调作业时调到正确的转动角度。黑色刀头装配精度高，具有良好的防腐蚀性。

“Take it easy”工具查找系统按彩色标签辨识花头和尺寸—轻松又快捷找到所需工具。

- 防静电工具，表面电阻 $\leq 10^9$ Ohm
- Kraftform多重材料精密手柄，符合人体工程学，可快速拆装螺丝
- 维拉黑色刀头，可精确配合，具有最佳的抗腐蚀性
- “易寻”色标系统：用特定的颜色代表不同端头种类和尺寸
- 带防滚动保护和旋转帽用于快速旋转

1578 A ESD Kraftform 防静电精密一字螺丝刀



	EAN							
Code	4013288	mm	mm	mm	mm	mm	mm	
05030099001	215253	0,16	0,8	40	97	2,0	1/32"	5
05030101001	039040	0,23	1,5	40	97	2,0	1/16"	5
05030100001	039033	0,25	1,2	40	97	2,0	0,05"	5
05030102001	039057	0,30	1,8	60	97	2,0	0,07"	5
05030108001	194763	0,35	2,5	40	97	2,5	3/32"	5
05030103001	039064	0,40	2,0	60	97	2,5	5/64"	5
05030104001	039071	0,40	2,5	80	97	2,5	3/32"	5
05030105001	039088	0,50	3,0	80	97	3,0	1/8"	5
05030106001	039095	0,60	3,5	80	97	4,0	9/64"	5
05030107001	039101	0,80	4,0	80	97	4,0	5/32"	5

1550 PH ESD Kraftform 防静电精密十字螺丝刀



	EAN						
Code	4013288		mm	mm	mm	mm	
05030117001 ¹⁾ 2)	194725	PH 000	40	97	1,5/2,5	1 9/16"	5
05030118001 ¹⁾ 2)	194732	PH 00	40	97	1,8/2,5	1 9/16"	5
05030110001 ²⁾	039118	PH 00	60	97	1,8/2,5	2 3/8"	5
05030119001 ³⁾	194749	PH 0	40	97	3,0	1 9/16"	5
05030111001 ³⁾	039125	PH 0	60	97	3,0	2 3/8"	5
05030112001	039132	PH 1	80	97	4,0	3 1/8"	5

¹⁾ 专为亚洲的十字PH螺丝优化

²⁾ 刀头的标称长度为10 mm

³⁾ 尺寸0根据JCS 0 (日本相机工业标准) 修改

1550 PH S ESD防静电 Krafftform 精密螺丝刀



	EAN						
Code	4013288		mm	mm			
05030109001	215222	# 01	40	97	1 9/16"		5

1555 PZ ESD Krafftform 防静电精密米字螺丝刀



	EAN						
Code	4013288		mm	mm	mm		
05030115001	039149	PZ 0	60	97	3,0	2 3/8"	5
05030116001	039156	PZ 1	80	97	4,0	3 1/8"	5

梅花齿廓固持工具系列

卡紧梅花型螺丝的楔入力

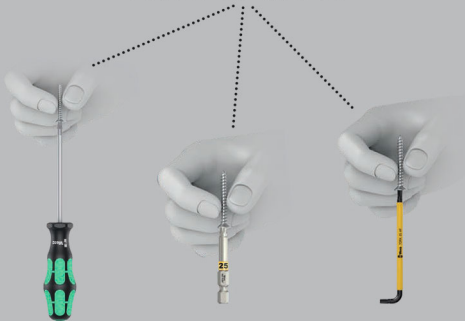

1567 TORX® HF ESD Krafftform 防静电精密梅花螺丝刀·带固持功能



	EAN						
Code	4013288		mm	mm	mm		
05030400001	183972	TX 4	40	97	2,5	1 9/16"	5
05030401001	183989	TX 5	40	97	3,0	1 9/16"	5
05030402001	183996	TX 6	40	97	3,0	1 9/16"	5
05030403001	184009	TX 7	60	97	3,0	2 3/8"	5
05030404001	184016	TX 8	60	97	3,0	2 3/8"	5
05030405001	184023	TX 9	60	97	4,0	2 3/8"	5
05030406001	184030	TX 10	60	97	4,0	2 3/8"	5

1567 TORX® ESD Krafftform 防静电精密梅花螺丝刀



	EAN						
Code	4013288		mm	mm	mm		
05030158001	215239	TX 2	40	97	2,0	1 9/16"	5
05030159001	215246	TX 3	40	97	2,0	1 9/16"	5
05030120001	039163	TX 4	40	97	2,5	1 9/16"	5
05030121001	039170	TX 5	40	97	3,0	1 9/16"	5
05030122001	039187	TX 6	40	97	3,0	1 9/16"	5

1567 TORX® BO ESD Krafftform 精密防盗梅花螺丝刀



	EAN						
Code	4013288		mm	mm	mm		
05030113001	219473	TX 6 BO	60	97	3,0	2 3/8"	5
05030114001	219480	TX 8 BO	60	97	3,0	2 3/8"	5

1567 五星螺丝刀 ESD Krafftform Micro · 适用于电子应用



	EAN						
Code	4013288		mm	mm	mm		
05030135001 ¹⁾	194756	1 IPR	40	97	2,0	1 9/16"	5

¹⁾ 无球头

1572 Krafftform 防静电精密Microstix® 三叶螺丝刀



	EAN						
Code	4013288		mm	mm	mm		
05030080001	181169	m	40	97	2,5	1 9/16"	5
05030081001	181176	00	40	97	2,5	1 9/16"	5
05030082001	181183	F	40	97	2,5	1 9/16"	5
05030083001	181190	0	40	97	2,5	1 9/16"	5
05030084001	181206	1	40	97	2,5	1 9/16"	5

1573 Pentalobe ESD防静电 Krafftform 精密螺丝刀

- Krafftform 精密螺丝刀, 适用于 Pentalobe 螺钉

1573 Pentalobe ESD防静电 Krafftform 精密螺丝刀



	EAN						
Code	4013288		mm	mm	mm		
05030330001	219435	PL 1,1	40	97	2,0	1 9/16"	5
05030331001	219497	PL 1,4	40	97	2,0	1 9/16"	5

1569 ESD 防静电精密螺母螺丝刀



	EAN						
Code	4013288		mm	mm	mm		
05030410001	184047	1,5	60	97	5,7	2 3/8"	5
05030411001	184054	1,8	60	97	5,7	2 3/8"	5
05030412001	184061	2,0	60	97	5,7	2 3/8"	5
05030413001	184078	2,5	60	97	5,7	2 3/8"	5
05030414001	184085	3,0	60	97	5,7	2 3/8"	5
05030415001	184092	3,2	60	97	5,7	2 3/8"	5
05030416001	184108	3,5	60	97	5,7	2 3/8"	5
05030417001	184115	4,0	60	97	5,7	2 3/8"	5
05030418001	184122	4,5	60	97	6,4	2 3/8"	5
05030150001	093486	5,0	60	97	7,0	2 3/8"	5
05030151001	093493	5,5	60	97	7,8	2 3/8"	5

1529 ESD防静电 芯片提升器

- 芯片起子用于脱焊后起出电路板上牢固安装的零件

1529 ESD防静电 芯片提升器



	EAN						
Code	4013288	mm	mm	mm	mm		
05027450001	219428	1,0	3,5	50	97		10

Kraftform 精密 ESD防静电 Big Pack 1 电子组装用螺丝刀套装

防静电的维拉 精密螺丝刀 25 件式套装。所含的螺钉花形特别适用于手机和平板电脑。提供安全保护,防止静电能量和相关损坏。

将手撑在旋转盖上,通过旋转盖下方的快速旋转区,可实现闪电式快速旋转。

省去耗时的手动切换。带有集成式软质区的动力区确保高拧紧和松开力矩的传输。精密区确保在调整时的旋转角度正确。

Black Point 刀头可提高装配精度,提供最佳的防腐保护。

“Take it easy” 易寻系统,按花形进行尺寸冲压和彩色编码,以快速、轻松地找到所需的工具。在坚固的织物袋中储存和运输,因此对工具提供妥善的保护并且随时可用。

- 包含特别适用于手机的螺丝刀花形、平板电脑和笔记本电脑/台式电脑的维修。
- 在坚固的织物盒中存放和运输,因此对工具提供妥善的保护并且随时可用。

Kraftform 精密 ESD防静电 Big Pack 1 电子组装用螺丝刀套装



Code	EAN		
05134019001	4013288 219459		1
		1550 PH ESD Micro 1x PH 000x40 ^{1) 2)} ; 1x PH 00x40 ^{1) 2)} ; 1x PH 0x40 ³⁾ ; 1x PH 1x80	
		1550 PH S ESD Micro 1x # 01x40	
		1567 TORX® HF ESD Micro 1x TX 8x60; 1x TX 10x60	
		1567 TORX® ESD Micro 1x TX 2x40; 1x TX 3x40; 1x TX 4x40; 1x TX 5x40; 1x TX 6x40	
		1567 TORX® B0 ESD Micro 1x TX 6 B0x60; 1x TX 8 B0x60	
		1567 TORX PLUS® IPR ESD 1x 1 IPRx40	
		1572 ESD 1x mx40; 1x 00x40; 1x Fx40; 1x 0x40	
		1573 Pentalobe ESD 1x PL 1,1x40; 1x PL 1,4x40	
		1569 ESD 1x 3,0x60	
		1578 A ESD Micro 1x 0,16x0,8x40; 1x 0,23x1,5x40	
		1529 ESD 1x 1,0x3,5x50	

¹⁾ 专为亚洲的十字PH螺丝优化

²⁾ 刀头的标称长度为10 mm

³⁾ 尺寸0根据JCS 0 (日本相机工业标准) 修改

1578 A/6 防静电精密螺丝刀组套·带刀架

- 含实用的刀架,可整齐存放螺丝刀

1578 A/6 防静电精密螺丝刀组套·带刀架



Code	EAN			
05030170001	4013288 113900			1
		+	1550 PH ESD Micro 1x PH 0x60 ¹⁾ ; 1x PH 1x80	
		-	1578 A ESD Micro 1x 0,23x1,5x40; 1x 0,25x1,2x40; 1x 0,30x1,8x60; 1x 0,40x2,5x80	

¹⁾尺寸0根据JIS 0 (日本相机工业标准) 修改

1550/6 ESD 防静电精密螺丝刀组套·带刀架

- 含实用的刀架,可整齐存放螺丝刀

1550/6 ESD 防静电精密螺丝刀组套·带刀架



Code	EAN			
05030180001	4013288 194787			1
		+	1550 PH ESD Micro 1x PH 000x40 ^{1) 2)} ; 1x PH 00x40 ^{1) 2)} ; 1x PH 0x40 ³⁾	
		-	1578 A ESD Micro 1x 0,35x2,5x40	
		+	1567 TORX PLUS® IPR ESD 1x 1 IPRx40	
		+	1572 ESD 1x mx40	

¹⁾ 专为亚洲的十字PH螺丝优化

²⁾ 刀头的标称长度为10 mm

³⁾ 尺寸0根据JIS 0 (日本相机工业标准) 修改

1013 Kraftform 防静电精密螺丝刀手柄

ESD安全螺丝刀的规格要求在欧洲EN 61340-5-1标准中也有详细说明,这项标准也包括手柄制作时所使用的导线通料。

维拉的ESD系列产品满足这些标准,甚至可以满足某些技术公司提出的更为严苛的标准。

具有可适配半月驱动和HIOS双耳驱动批头的接头。可用于手机、移动电话、照相机及其他电子设备。

- Kraftform防静电精密批头接杆
- 防静电工具,表面电阻 $\leq 10^9$ Ohm
- Kraftform多重材料精密手柄,带防滚动保护和旋转帽
- 用于4mm半月驱动的批头夹具和4mm HIOS驱动的批头
- 可用于手机、移动电话、照相机及其他电子设备

1013 Kraftform 防静电精密螺丝刀手柄



	EAN	□	□	□				
Code	4013288	mm	mm					1
05300004001	168610	23	97	29/32"				

Rapidaptor 快速批头接杆 – 令人惊艳的多功能工具



- ESD防静电批头接杆, 用于防静电安全作业
- 表面电阻 $\leq 10^9$ Ohm
- Kraftform多重材料手柄, 符合人体工程学, 可快速拆装螺丝
- 六角防滚动保护, 防止螺丝刀的滚动
- 1/4"六角快速接头

816 R ESD 防静电螺丝刀手柄 · 无磁性



	EAN								
Code	4013288		mm						
05051464001	103918	1/4"	119						2

813 R ESD 防静电螺丝刀手柄 · 无磁性



	EAN								
Code	4013288		mm						
05051273001	103901	1/4"	90						2

Kraftform Kompakt 60 ESD 螺丝批组套

89mm批头, 帆布包装
17件套。1个Kraftform 816 R ESD 螺丝刀柄, 带快速接头。

维拉ESD材料的表面电阻 $\leq 10^9$ Ohm, 能有效地保护组件, 防止其产生静电并遭受相关的危害。

- 用于手动和电动工具
- 光滑的硬质区可在手上快速滑动, 软质抓握区可传递更大扭力
- Rapidaptor快速接头
- 坚固而具有韧性的通用批头
- 坚固的帆布腰包装

Kraftform Kompakt 60 ESD 螺丝批组套



Code	EAN			
05051043001	183934			1
			816 R ESD 1x 1/4"x119	
			851/4 Z PH 1x PH 1x89; 1x PH 2x89; 1x PH 3x89	
			855/4 Z PZ 1x PZ 1x89; 1x PZ 2x89; 1x PZ 3x89	
			867/4 Z TORX® B0 1x TX 10x89; 1x TX 15x89; 1x TX 20x89; 1x TX 25x89; 1x TX 30x89	
			840/4 Z Hex-Plus 1x 3,0x89; 1x 4,0x89; 1x 5,0x89; 1x 6,0x89	
			800/4 Z 1x 1,0x5,5x89	

Kraftform Kompakt Micro 21 ESD 1 防静电精密螺丝批组套

ESD安全螺丝刀的规格要求在欧洲EN 61340-5-1标准中也有详细说明，这项标准也包括手柄制作时所使用的导线通料。维拉的ESD系列产品满足这些标准，甚至可以满足某些技术公司提出的更为严苛的标准。具有可适配半月驱动和HIOS双耳驱动批头的接头。独特设计的快速手柄能快速换装刀杆。

Kraftform精密手柄，符合人体工程学，可快速作业。可更换式刀杆可以实现快速换装。在精调作业时，刀杆正上方的精密区域让用户可以很轻松地旋转到正确的转动角度。刀头端附近的力量区域融合了软质材料，确保松开或紧固螺丝的高扭力传输，防止螺丝刀滑出螺丝。

自由旋转螺帽下面的快速旋转区域使螺丝刀可快速转动，从而避免了使用其他普通精密螺丝刀时所需的握持位置调整。

Kraftform Kompakt Micro 21 ESD 1 防静电精密螺丝批组套



Code	EAN		
05135973001	194855		1
		1013 Kraftform Micro ESD 1x 97	
		851/9 C 1x PH 00x44 ¹⁾ ; 1x PH 0x44 ²⁾	
		867/9 C TORX® 1x TX 1x44; 1x TX 2x44; 1x TX 3x44; 1x TX 4x44; 1x TX 5x44	
		867/9 C TORX PLUS® 1x 1 IPx44; 1x 2 IPx44; 1x 3 IPx44; 1x 4 IPx44	
		867/9 IPR TORX® PLUS 1x 1 IPRx44	
		872/9 1x mx44; 1x 00x44; 1x Fx44; 1x 0x44	
		800/9 C 1x 0,23x1,5x44; 1x 0,35x2,5x44	
		869/9 1x 2,5x44,0	

¹⁾ 专为亚洲的十字PH螺丝优化

²⁾ 尺寸0根据JCS 0 (日本相机工业标准) 修改

Kraftform Kompakt Micro 20 ESD 1 防静电精密螺丝批组套

- 批头接杆，用于4mm半月和HIOS驱动的批头
- 手柄材料的表面电阻 ≤ 10⁹ Ohm
- 独特设计的快速手柄能快速换装刀杆
- Kraftform精密手柄，带旋转帽，可快速旋转
- 手动和电动工具批头

Kraftform Kompakt Micro 20 ESD 1 防静电精密螺丝批组套



Code	EAN		
05073671001	169662		1
		1013 Kraftform Micro ESD 1x 97	
		851/9 C 1x PH 00x44 ¹⁾ ; 1x PH 0x44 ²⁾ ; 1x PH 1x44 ¹⁾	
		867/9 C TORX® 1x TX 1x44; 1x TX 2x44; 1x TX 3x44; 1x TX 4x44; 1x TX 5x44; 1x TX 6x44	
		867/9 C TORX PLUS® 1x 1 IPx44; 1x 2 IPx44; 1x 3 IPx44; 1x 4 IPx44	
		840/9 C 1x 1,5x44; 1x 2,0x44	
		800/9 C 1x 0,23x1,5x44; 1x 0,40x2,0x44; 1x 0,50x3,0x44	
		867/9 IPR TORX® PLUS 1x 1 IPRx44	

¹⁾ 专为亚洲的十字PH螺丝优化

²⁾ 尺寸0根据JCS 0 (日本相机工业标准) 修改

Kraftform Kompakt Micro 11 ESD 1 防静电精密螺丝批组套



Code	EAN		
05073670001	168344		1
		1013 Kraftform Micro ESD 1x 97	
		851/9 C 1x PH 00x44 ¹⁾ ; 1x PH 0x44 ²⁾ ; 1x PH 1x44 ¹⁾	
		867/9 C TORX® 1x TX 5x44; 1x TX 6x44	
		800/9 C 1x 0,23x1,5x44; 1x 0,40x2,0x44; 1x 0,50x3,0x44	
		840/9 C 1x 1,5x44; 1x 2,0x44	

¹⁾ 专为亚洲的十字PH螺丝优化

²⁾ 尺寸0根据JICIS 0 (日本相机工业标准) 修改

Kraftform Kompakt Stubby ESD 1

可快速更换刀杆的手柄/换装刀杆系统。带有短刀杆331的ESD小批头接头用于静电安全作业,在狭小空间也游刃有余。

适用于符合 DIN ISO 1173-C 6.3标准的 1/4"六角驱动批头以及维拉系列1 强磁性磁将又大又重的螺丝也牢牢固定。双重材料手柄有硬质和软质区,确保牢固握抓并精确作业。

高品质通用批头 紧凑的织布盒坚固,体积小,重量轻。适宜用于Wera2go系列产品。

- 防静电ESD 螺丝刀柄,磁性
- 851/1 J: 专为亚洲PH-十字螺丝优化的批头

Kraftform Kompakt Stubby ESD 1



Code	EAN		
05057472001	214584		1
		811/1 Stubby ESD 1x 1/4"x54	
		851/1 Z PH 1x PH 0x25; 1x PH 1x25; 1x PH 2x25	
		851/1 J 1x PH 00x25x2,0 ¹⁾	
		800/1 Z 1x 0,5x3,0x25; 1x 0,6x4,5x25; 1x 1,0x5,5x25; 1x 1,2x6,5x25; 1x 1,2x8,0x25	

¹⁾ 尺寸00根据JICIS 00 (日本相机工业标准) 修改

809/1 ESD防静电 Stubby 批头手动接头 · 带卡环

- 小巧设计适合狭小空间内作业
- 批头接杆,带卡环,用于1/4"六角驱动的批头

809/1 ESD防静电 Stubby 批头手动接头 · 带卡环



	EAN						
Code	4013288		mm	mm			
05008882001	219206	1/4"	10	54	3/8"		2

811/1 ESD Stubby 防静电迷你螺丝刀柄 · 磁性

- 小巧设计适合狭小空间内作业
- 符合人体工程学的双重材料 Kraftform 手柄提升作业精确度
- 六角防滚动保护,防止螺丝刀的滚动
- 防静电ESD 螺丝刀柄,磁性
- 符合DIN ISO 1173-C 6.3标准的1/4" 批头

811/1 ESD Stubby 防静电迷你螺丝刀柄 · 磁性



	EAN						
Code			mm	mm			
05008881001	212382	1/4"	10	54	3/8"		2

9514 ESD 加消磁器 SB

着磁装置。只需沿着 Wera 着磁装置的正极拉动工具,工具就会将螺丝牢牢固定在刀杆上。

要消磁,沿负极移动刀具。

- 加消磁器
- 防静电工具,表面电阻 $\leq 10^9$ Ohm
- 充磁和消磁工具头
- 工具稳固夹持螺丝

9514 ESD 加消磁器 SB



	EAN						
Code	4013288	mm					
05073984001	225924	64,6					1

Kraftform 不锈钢系列 – 避免生锈

维拉的不锈钢工具通过真空冰处以达到所需硬度和强度，可满足工业级别的应用。

不锈钢材质避免外因锈蚀形成

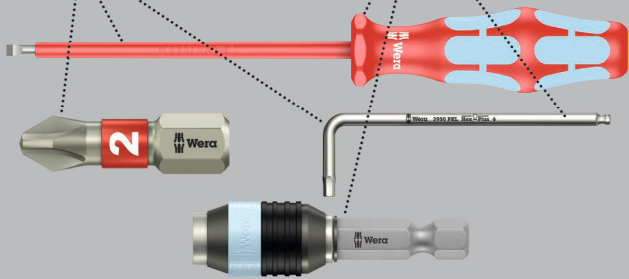

生锈问题的解决方案: 使用不锈钢工具拆装不锈钢螺丝。维拉不锈钢工具是由不锈钢材料制成, 可有效避免难看的锈蚀。维拉的不锈钢工具通过真空冰处以达到所需硬度和强度, 可满足工业级别的应用。按照IEC 60900的标准, 每件工具都必须通过10,000伏的绝缘性能测试, 保证其在1,000伏的环境下能安全工作。

在-40°C下进行冲击韧性测试, 以确保工具在极端环境下也能安全工作。

“Take it easy” 工具易寻色标系统: 通过彩色标识, 辨别螺丝刀头类型与大小。让用户更快的在工具包中找到自己所需要的工具。六角防滚设计能消除工作中因置放螺丝刀时的滚动而带来的烦恼。

Lasertip 激光切 – 镭射蚀刻刀头

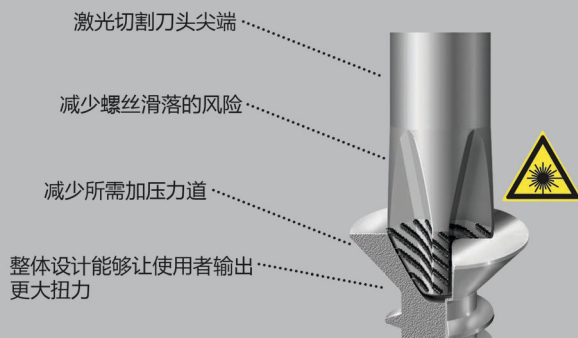

3160 i VDE 不锈钢一字绝缘螺丝刀



	EAN							
Code	4013288	mm	mm	mm	mm			
05022729001 ¹⁾	122353	0,5	3,0	80	81	1/8"	3 1/8"	10
05022730001 ¹⁾	122148	0,6	3,5	100	81	9/64"	4"	10
05022731001	122155	0,8	4,0	100	98	5/32"	4"	10
05022732001	122162	1,0	5,5	125	98	7/32"	5"	10

¹⁾ 不带Lasertip激光蚀刻刀头

3162 i PH VDE 不锈钢十字绝缘螺丝刀



	EAN						
Code	4013288		mm	mm			
05022733001	122179	PH 1	80	98	3 1/8"		5
05022734001	122186	PH 2	100	105	4"		5

3165 i PZ VDE 不锈钢米字绝缘螺丝刀



	EAN						
Code	4013288		mm	mm			
05022740001	183941	PZ 1	80	98	3 1/8"		5
05022741001	183965	PZ 2	100	105	4"		5

3167 i 电设用 绝缘 TORX® 螺丝刀 · 不锈钢



Code	EAN	Icon	TX	mm	mm	inch	Box
05022760001	220103	★	TX 8	80	81	3 1/8"	5
05022761001	220110	★	TX 9	80	81	3 1/8"	5
05022762001	220127	★	TX 10	80	81	3 1/8"	5
05022763001	220134	★	TX 15	80	98	3 1/8"	5
05022764001	220141	★	TX 20	80	98	3 1/8"	5
05022765001	220158	★	TX 25	100	105	4"	5
05022766001	220165	★	TX 30	100	105	4"	5

3160 i/7 不锈钢VDE绝缘螺丝刀组套 · 带刀架

• 含可有序存放螺丝刀的实用刀架

3160 i/7 不锈钢VDE绝缘螺丝刀组套 · 带刀架



Code	EAN	Icon	Description	Box
05022728001	118073	+	3162 i VDE 1x PH 1x80; 1x PH 2x100	1
		-	3160 i VDE 1x 0,5x3,0x80 ¹⁾ ; 1x 0,6x3,5x100 ¹⁾ ; 1x 0,8x4,0x100; 1x 1,0x5,5x125	
		-	3247 1x 0,5x3,0x70	

¹⁾ 不带Lasertip激光蚀刻刀头
²⁾ 未在美国和加拿大上市

3165 i/6 不锈钢螺丝刀组套 · 带刀架

• 含可有序存放螺丝刀的实用刀架

3165 i/6 不锈钢螺丝刀组套 · 带刀架



Code	EAN	Icon	Description	Box
05022745001	184207	+	3165 i PZ VDE 1x PZ 1x80; 1x PZ 2x100	1
		-	3160 i VDE 1x 0,5x3,0x80 ¹⁾ ; 1x 0,6x3,5x100 ¹⁾ ; 1x 0,8x4,0x100; 1x 1,0x5,5x125	

¹⁾ 不带Lasertip激光蚀刻刀头

3167 i/7 TORX® 螺丝刀组套 · 不锈钢 · 含展示架

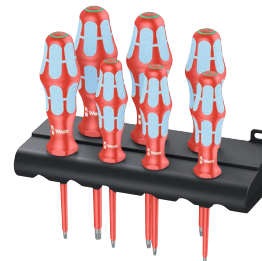
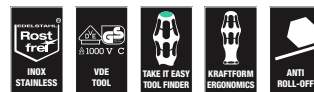

Code	EAN	Icon	Description	Box
05022767001	220172	★	3167 i TORX® VDE 1x TX 8x80; 1x TX 9x80; 1x TX 10x80; 1x TX 15x80; 1x TX 20x80; 1x TX 25x100; 1x TX 30x100	1

Lasertip 激光切 – 镭射蚀刻刀头

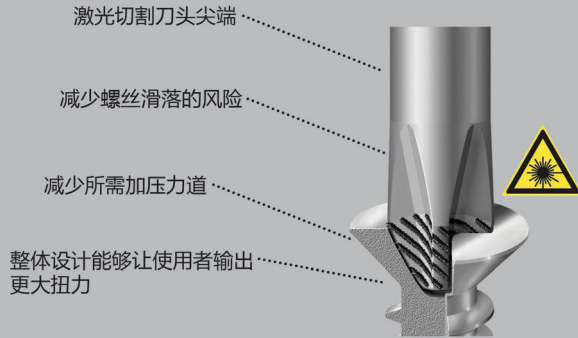

手柄的硬质材料使手部皮肤在握持时不会黏着手柄，而周围的大直径硬质区像轮子一样，可以快速转动。按照 IEC 60900 的标准，每件工具都必须通过 10,000 伏的绝缘性能测试，保证其在 1,000 伏的环境下能安全工作。

螺丝刀头用激光蚀刻出带有锋利边缘的沟槽，其硬度可高达 1000 HV 0.3。维拉 Lasertip 激光蚀刻刀头能抓紧螺丝头，有效防止打滑，可适用于一字、十字米字花螺丝。

“Take it easy” 工具易寻色标系统：通过彩色标识，辨别螺丝刀头类型与大小。让用户更快的在工具包中找到自己所需要的工具。六角防滚设计能消除工作中因置放螺丝刀时的滚动而带来的烦恼。

- 绝缘螺丝刀，在 1000V 电压下仍可安全作业
- 光滑的硬质区可在手上快速滑动，软质抓握区可传递更大扭力
- “易寻”色标系统：用特定的颜色代表不同端头种类和尺寸
- 六角防滚滚动保护，防止螺丝刀的滚动
- 锥形刀杆，Lasertip 激光蚀刻刀头

160 i VDE 一字绝缘螺丝刀

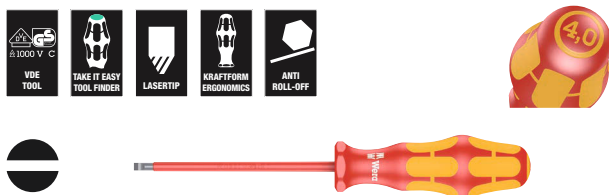

Code	EAN	mm	mm	mm	mm	mm	mm	mm	mm
05006100001 ¹⁾	027221	0,4	2,5	80	81	3/32"	3 1/8"	10	
05006105001 ¹⁾	027238	0,5	3,0	100	81	1/8"	4"	10	
05006110001 ¹⁾	027245	0,6	3,5	100	81	9/64"	4"	10	
05006115001	027252	0,8	4,0	100	98	5/32"	4"	10	
05006116001	105431	0,8	4,0	150	98	5/32"	6"	5	
05006120001	027269	1,0	5,5	125	98	7/32"	5"	10	
05006121001	105448	1,0	5,5	200	98	7/32"	8"	5	
05006125001	027276	1,2	6,5	150	105	1/4"	6"	10	
05006126001	105455	1,2	6,5	200	105	1/4"	8"	5	
05006130001	027283	1,2	8,0	175	112	5/16"	7"	5	
05006135001	028884	1,6	8,0	200	112	5/16"	8"	5	
05006140001	028877	1,6	10,0	200	112	3/8"	8"	5	

¹⁾ 不带 Lasertip 激光蚀刻刀头

160 i VDE 一字绝缘螺丝刀吊卡装



Code	EAN	mm	mm	mm	mm	mm	mm	mm
05100000001	181466	0,4	2,5	80	81	3/32"	3 1/8"	10
05100001001	181473	0,5	3,0	100	81	1/8"	4"	10
05100002001	181480	0,6	3,5	100	81	9/64"	4"	10
05100003001	181497	0,8	4,0	100	98	5/32"	4"	10
05100004001	181503	1,0	5,5	125	98	7/32"	5"	10

¹⁾ 不带 Lasertip 激光蚀刻刀头

160 iS VDE 一字绝缘螺丝刀 · 小直径刀杆

- 小直径刀杆
- 可在狭小空间内拆装螺丝
- 可进入并安装沉头螺丝以及弹簧原件

160 iS VDE 一字绝缘螺丝刀 · 小直径刀杆



Code	EAN	mm	mm	mm	mm	mm	mm	mm
05006440001	160089	0,6	3,5	100	81	9/64"	4"	10
05006441001	160102	0,8	4,0	100	98	5/32"	4"	10
05006442001	160126	1,0	5,5	125	98	7/32"	5"	10

160 iSS VDE 一字绝缘螺丝刀 · 小直径刀杆

- 小直径刀杆和手柄
- 可在狭小空间内拆装螺丝
- 可进入并安装沉头螺丝以及弹簧原件

160 iSS VDE 一字绝缘螺丝刀 · 小直径刀杆



Code	EAN	mm	mm	mm	mm	mm	mm	mm
05020129001	179548	0,8	4,0	100	81	5/32"	4"	5

162 i PH VDE 十字绝缘螺丝刀



Code	EAN	+	mm	mm	mm		
05006150001 ¹⁾	027290	PH 0	80	81	3 1/8"		5
05006152001	027306	PH 1	80	98	3 1/8"		5
05006153001	105417	PH 1	150	98	6"		5
05006154001	027313	PH 2	100	105	4"		5
05006159001	105424	PH 2	200	105	8"		5
05006156001	027320	PH 3	150	112	6"		5
05006158001 ¹⁾	027818	PH 4	200	112	8"		2

¹⁾ 不带Lasertip激光蚀刻刀头

162 i PH VDE 十字绝缘螺丝刀吊卡装



Code	EAN	+		
05100011001	181442	+	162 i PH VDE 1x PH 1x80	5
05100012001	181459	+	162 i PH VDE 1x PH 2x100	5

162 iS PH VDE 十字绝缘螺丝刀 · 小直径刀杆

- 小直径刀杆
- 可在狭小空间内拆装螺丝
- 可进入并安装沉头螺丝以及弹簧原件

162 iS PH VDE 十字绝缘螺丝刀 · 小直径刀杆



Code	EAN	+	mm	mm	mm		
05006450001	160140	PH 1	80	98	3 1/8"		5
05006451001	160164	PH 2	100	105	4"		5

162 iSS PH VDE 十字绝缘螺丝刀 · 小直径刀杆

- 小直径刀杆和手柄
- 可在狭小空间内拆装螺丝
- 可进入并安装沉头螺丝以及弹簧原件



162 iSS PH VDE 十字绝缘螺丝刀 · 小直径刀杆



Code	EAN	+	mm	mm	mm		
05020131001	179432	PH 1	80	81	3 1/8"		5
05020133001	179425	PH 2	100	98	4"		5

165 i PZ VDE 米字绝缘螺丝刀



Code	EAN	+	mm	mm	mm		
05006160001 ¹⁾	032782	PZ 0	80	81	3 1/8"		5
05006162001	029836	PZ 1	80	98	3 1/8"		5
05006163001	105462	PZ 1	150	98	6"		5
05006164001	029843	PZ 2	100	105	4"		5
05006165001	105479	PZ 2	200	105	8"		5
05006166001	029850	PZ 3	150	112	6"		5
05006168001 ¹⁾	029867	PZ 4	200	112	8"		2

¹⁾ 不带Lasertip激光蚀刻刀头

165 i PZ VDE 米字绝缘螺丝刀吊卡装

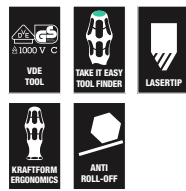

Code	EAN	+		
05100015001	181510	+	165 i PZ VDE 1x PZ 1x80	5
05100016001	181527	+	165 i PZ VDE 1x PZ 2x100	5

165 iS PZ VDE 米字绝缘螺丝刀 · 小直径刀杆

- 小直径刀杆
- 可在狭小空间内拆装螺丝
- 可进入并安装沉头螺丝以及弹簧原件

165 iS PZ VDE 米字绝缘螺丝刀 · 小直径刀杆

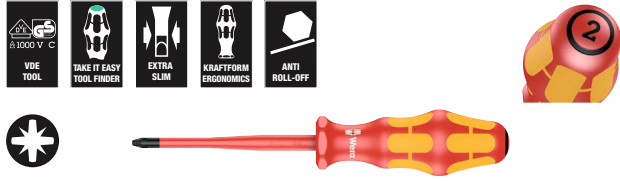

	EAN						
Code	4013288		mm	mm			
05006460001	160188	PZ 1	80	98	3 1/8"		5
05006461001	160249	PZ 2	100	105	4"		5

162 i PH/S VDE 穿心十字绝缘螺丝刀

- 用于穿心十字螺丝

162 i PH/S VDE 穿心十字绝缘螺丝刀



	EAN						
Code	4013288		mm	mm			
05006380001	102614	# 1	80	98	3 1/8"		5
05006381001	102621	# 2	100	105	4"		5

162 i PH/S SB VDE 绝缘穿心十字螺丝刀

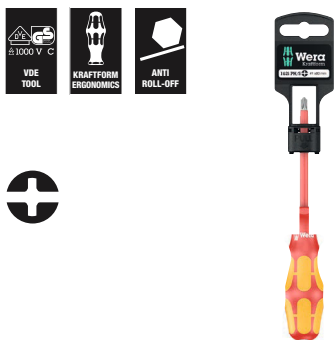

	Code	EAN		
		4013288		
	05100019001	186560	162 i PH/S VDE 1x # 1x80	5
	05100020001	186577	162 i PH/S VDE 1x # 2x100	5

162 iS PH/S VDE 穿心十字绝缘螺丝刀 · 小直径刀杆

- 小直径刀杆, 用于穿心十字螺丝
- 可在狭小空间内拆装螺丝
- 可进入并安装沉头螺丝以及弹簧原件

162 iS PH/S VDE 穿心十字绝缘螺丝刀 · 小直径刀杆



	EAN						
Code	4013288		mm	mm			
05006455001	160201	# 1	80	98	3 1/8"		5
05006456001	160225	# 2	100	105	4"		5

165 i PZ/S VDE 穿心米字绝缘螺丝刀

- 用于穿心米字螺丝

165 i PZ/S VDE 穿心米字绝缘螺丝刀



	EAN						
Code	4013288		mm	mm			
05006190001	102638	# 1	80	98	3 1/8"		5
05006191001	102645	# 2	100	105	4"		5

165 i PZ/S SB VDE 绝缘穿心米字螺丝刀

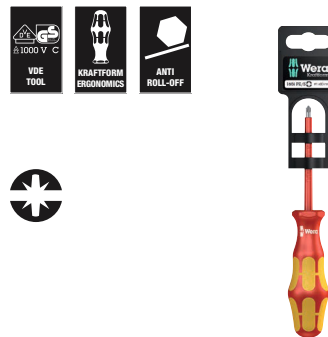

	Code	EAN		
		4013288		
	05100021001	186584	165 i PZ/S VDE 1x # 1x80	5
	05100022001	186591	165 i PZ/S VDE 1x # 2x100	5

165 iS PZ/S VDE 穿心米字绝缘螺丝刀 · 小直径刀杆

- 小直径刀杆, 用于穿心米字螺丝
- 可在狭小空间内拆装螺丝
- 可进入并安装沉头螺丝以及弹簧原件

165 iS PZ/S VDE 穿心米字绝缘螺丝刀 · 小直径刀杆



Code	EAN	⊕	⌀	⌀	⌀		
	4013288		mm	mm			
05006465001	160263	# 1	80	98	3 1/8"		5
05006466001	160287	# 2	100	105	4"		5

165 iSS PZ/S VDE 穿心米字绝缘螺丝刀 · 小直径刀杆

- 小直径刀杆和手柄
- 可在狭小空间内拆装螺丝
- 可进入并安装沉头螺丝以及弹簧原件

165 iSS PZ/S VDE 穿心米字绝缘螺丝刀 · 小直径刀杆



Code	EAN	⊕	⌀	⌀	⌀		
	4013288		mm	mm			
05020132001	179418	# 1	80	81	3 1/8"		5
05020134001	179401	# 2	100	98	4"		5

167 i VDE TORX® 梅花绝缘螺丝刀



Code	EAN	⊕	⌀	⌀	⌀		
	4013288		mm	mm			
05006181001	108876	TX 5	80	81	3 1/8"		5
05006182001	108883	TX 6	80	81	3 1/8"		5
05006183001	108890	TX 7	80	81	3 1/8"		5
05006184001	108906	TX 8	80	81	3 1/8"		5
05006169001	036452	TX 9	80	81	3 1/8"		5
05006170001	036667	TX 10	80	81	3 1/8"		5
05006172001	036674	TX 15	80	98	3 1/8"		5
05006174001	036681	TX 20	80	98	3 1/8"		5
05006176001	036698	TX 25	100	105	4"		5
05006177001	036469	TX 27	100	105	4"		5
05006178001	036704	TX 30	100	105	4"		5
05006179001	036476	TX 40	150	112	6"		5

168 i VDE 内四方头绝缘螺丝刀



Code	EAN	⊕	⌀	⌀	⌀		
	4013288		mm	mm			
05004780001	038777	# 1	80	98	3 1/8"		5
05004783001	105486	# 1	150	98	6"		5
05004781001	038784	# 2	100	105	4"		5
05004784001	105493	# 2	200	105	8"		5
05004782001	040909	# 3	150	112	6"		5

168 i VDE 内四方头绝缘螺丝刀吊卡装



Code	EAN	⊕		
	4013288			
05100024001	181534	⊕	168 i VDE 1x # 1x80	5
05100025001	181541	⊕	168 i VDE 1x # 2x100	5
05100026001	181558	⊕	168 i VDE 1x # 3x150	5

190 i VDE 绝缘螺母螺丝刀



	EAN							
Code	4013288	mm		mm	mm	mm		
05005300001	032485	5,5		125	98	11,0	5"	5
05005305001	032492	6,0		125	98	12,0	5"	5
05005310001	032508	7,0		125	105	14,0	5"	5
05005315001	032515	8,0		125	105	15,0	5"	5
05005320001	032522	9,0		125	105	16,0	5"	5
05005325001	032539	10,0		125	112	17,0	5"	5
05005330001	032546	11,0		125	112	19,0	5"	5
05005335001	032553	12,0		125	112	20,0	5"	5
05005340001	032560	13,0		125	112	21,0	5"	5

247 单极测电笔



	EAN							
Code	4013288	mm	mm	mm	mm			
05005655001	002686	0,5	3,0	70	3,0	1/8"	2 3/4"	5

¹⁾ 未在美国和加拿大上市

247 单极测电笔



Code	EAN			
05100100001	181664	247	1x 0.5x3.0x70	5

¹⁾ 未在美国和加拿大上市

Kraftform 100 VDE 绝缘大组套

14 件螺丝刀组套, 每个螺丝刀均通过独立测试并绝缘, 符合 IEC 60900 标准。接受 10,000 伏特水槽的单独测试, 以确保在 1,000 伏特的允许电压下安全工作。Kraftform 增强型手柄舒适、符合人体工程学, 使水泡和老茧成为过去。硬质区确保高效作业, 软质区确保高扭矩传输。部分激光打印刀头: 激光打印刀头抓紧螺丝头, 并防止意外滑出螺丝凹槽。含测电笔和 2 个刀架。

“易寻”色标系统, 用特定颜色代表不同花形和尺寸。防滚动保护, 防止螺丝刀的滚动。含测电笔和 2 个刀架。

- 绝缘螺丝刀, 在1000V电压下仍可安全作业
- Kraftform多重材料手柄, 符合人体工程学, 可快速拆装螺丝
- “易寻”色标系统: 用特定的颜色代表不同端头种类和尺寸
- 六角防滚动保护, 防止螺丝刀的滚动
- Lasertip激光蚀刻刀头, 可精确配合螺丝头

Kraftform 100 VDE 绝缘大组套

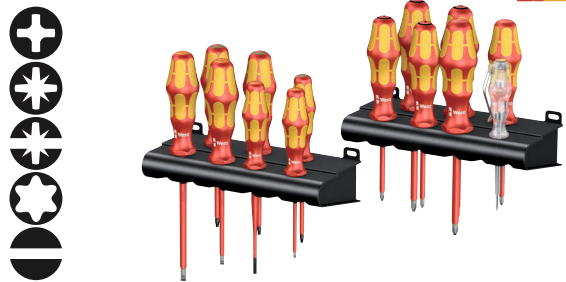

Code	EAN		
05105631001	163639		1
		162 i PH VDE 1x PH 1x80; 1x PH 2x100	
		165 i PZ VDE 1x PZ 1x80; 1x PZ 2x100	
		165 i PZ/S VDE 1x # 1x80; 1x # 2x100	
		167 i TORX® VDE 1x TX 10x80; 1x TX 15x80; 1x TX 20x80	
		160 iS 1x 0,6x3,5x100	
		160 i VDE 1x 0,4x2,5x80 ¹⁾ ; 1x 0,8x4,0x100; 1x 1,0x5,5x125	
		247 1x 0,5x3,0x70	
		Rack 2x 190,0x50,0	

¹⁾ 不带Lasertip激光蚀刻刀头

¹⁾ 未在美国和加拿大上市

Kraftform 2go 100 工具袋

11件VDE绝缘的Kraftform 螺丝刀,适用于十字PH及米PZ、TORX® 梅花型与一字。“Take it easy” 易寻色标识系统以颜色辨识螺丝刀花形与尺寸。附带一个可靠耐用工具插袋,带把手,方便运输与携带;耐刀割与穿刺,带魔术贴,可配合Wera2go工具包使用,并附赠一个有五个隔间可装卸的内袋。

- 带尼龙魔术贴,可粘贴到Wera 2go系列工具箱包上

Kraftform 2go 100 工具袋

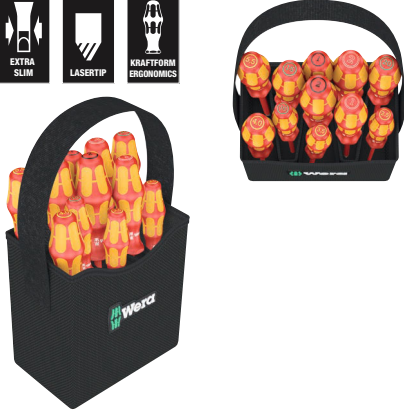

Code	EAN		
05004310001	187826		1
		Wera 2go 4 1x 165,0x165,0x105,0	
		⊕ 162 i PH VDE 1x PH 1x80; 1x PH 2x100	
		⊕ 165 i PZ VDE 1x PZ 1x80; 1x PZ 2x100	
		⊕ 167 i TORX® VDE 1x TX 10x80; 1x TX 15x80; 1x TX 20x80	
		● 160 i VDE 1x 0,4x2,5x80 ¹⁾ ; 1x 0,8x4,0x150; 1x 1,0x5,5x200	
		● 160 iS 1x 0,6x3,5x100	
		K120 1x 50,0x120,0	

¹⁾ 不带Lasertip激光蚀刻刀头

160 i/6 Kraftform Plus 100 绝缘系列螺丝刀组套 · 带刀架

- 含可有序存放螺丝刀的实用刀架

160 i/6 Kraftform Plus 100 绝缘系列螺丝刀组套 · 带刀架

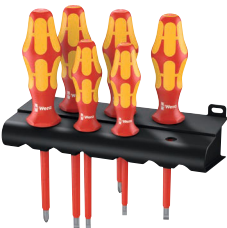

Code	EAN		
05006145001	027887		1
		⊕ 162 i PH VDE 1x PH 1x80; 1x PH 2x100	
		● 160 i VDE 1x 0,4x2,5x80 ¹⁾ ; 1x 0,6x3,5x100 ¹⁾ ; 1x 0,8x4,0x100; 1x 1,0x5,5x125	

¹⁾ 不带Lasertip激光蚀刻刀头

160 i/7 Kraftform Plus 100 系列螺丝刀组套 · 带单极测电笔和刀架

- 含可有序存放螺丝刀的实用刀架

160 i/7 Kraftform Plus 100 系列螺丝刀组套 · 带单极测电笔和刀架



Code	EAN		
05006147001	041708		1
		⊕ 162 i PH VDE 1x PH 1x80; 1x PH 2x100	
		● 160 i VDE 1x 0,4x2,5x80 ¹⁾ ; 1x 0,6x3,5x100 ¹⁾ ; 1x 0,8x4,0x100; 1x 1,0x5,5x125	
		● 247 1x 0,5x3,0x70	

¹⁾ 不带Lasertip激光蚀刻刀头
²⁾ 未在美国和加拿大上市

160 i/165 i/7 Kraftform Plus 100 绝缘系列螺丝刀组套 · 带单极测电笔和刀架

- 含可有序存放螺丝刀的实用刀架

160 i/165 i/7 Kraftform Plus 100 绝缘系列螺丝刀组套 · 带单极测电笔和刀架



Code	EAN		
05006148001	041715		1
		⊕ 165 i PZ VDE 1x PZ 1x80; 1x PZ 2x100	
		● 160 i VDE 1x 0,4x2,5x80 ¹⁾ ; 1x 0,6x3,5x100 ¹⁾ ; 1x 0,8x4,0x100; 1x 1,0x5,5x125	
		● 247 1x 0,5x3,0x70	

¹⁾ 不带Lasertip激光蚀刻刀头
²⁾ 未在美国和加拿大上市

167 i/6 Kraftform Plus 100 绝缘系列螺丝刀组套



Code		EAN		1
05133356001		4013288 160072		
		167 i TORX® VDE		
		1x TX 8x80; 1x TX 9x80; 1x TX 10x80;		
		1x TX 15x80; 1x TX 20x80; 1x TX 25x100		

160 iS/7 Kraftform Plus 100 绝缘系列螺丝刀组套 · 带单极测电笔和刀架 · 小直径刀杆

- 小直径刀杆
- 含可有序存放螺丝刀的实用刀架
- 可在狭小空间内拆装螺丝
- 可进入并安装沉头螺丝以及弹簧原件

160 iS/7 Kraftform Plus 100 绝缘系列螺丝刀组套 · 带单极测电笔和刀架 · 小直径刀杆



Code		EAN		1
05006480001		4013288 160713		
		162 iS		
		1x PH 1x80; 1x PH 2x100		
		165 iS PZ/S		
		1x # 2x100		
		160 iS		
		1x 0,6x3,5x100; 1x 0,8x4,0x100;		
		1x 1,0x5,5x125		
		247		
		1x 0,5x3,0x70		

¹⁾ 未在美国和加拿大上市

160 iSS/7 Kraftform 增强型 100 系列螺丝刀组套 · 小直径刀杆和手柄

- Kraftform螺丝刀, 小直径刀杆, 纤细型手柄设计
- 可在狭小空间内拆装螺丝
- 可进入并安装沉头螺丝以及弹簧原件
- 每一只都经过单独的水浴测试, 可在1000V电压下安全作业

160 iSS/7 Kraftform 增强型 100 系列螺丝刀组套 · 小直径刀杆和手柄



Code		EAN		1
05135961001		4013288 178640		
		160 iSS 1x 0,8x4,0x100		
		160 iS 1x 0,6x3,5x100; 1x 1,0x5,5x125		
		162 iSS 1x PH 1x80; 1x PH 2x100		
		165 iSS PZ/S 1x # 1x80; 1x # 2x100		

160 i/168 i/6 Kraftform Plus 100 绝缘系列螺丝刀组套 · 带刀架

- 含可有序存放螺丝刀的实用刀架

160 i/168 i/6 Kraftform Plus 100 绝缘系列螺丝刀组套 · 带刀架



Code		EAN		1
05347777001		4013288 122957		
		162 i PH VDE		
		1x PH 1x80; 1x PH 2x100		
		160 i VDE		
		1x 0,6x3,5x100 ¹⁾ ; 1x 1,0x5,5x125		
		168 i VDE		
		1x # 1x80; 1x # 2x100		

¹⁾ 不带Lasertip激光蚀刻刀头

160 i/162 i/167 i/9 Kraftform Plus 100 绝缘系列螺丝刀组套



Code	EAN		
05133355001	4013288 160065		1
		+	162 i PH VDE 1x PH 2x100
		+	165 i PZ VDE 1x PZ 2x100
		+	165 i PZ/S VDE 1x # 1x80; 1x # 2x100
		+	167 i TORX® VDE 1x TX 15x80; 1x TX 20x80; 1x TX 25x100
		●	160 i VDE 1x 0,4x2,5x80 ¹⁾ ; 1x 1,0x5,5x125

¹⁾ 不带Lasertip激光蚀刻刀头

165 iS PZ/S # 1 + 2 扳手套装Kraftform Plus系列100。小直径刀杆

- 小直径刀杆, 用于穿心米字螺丝
- 可在狭小空间内拆装螺丝
- 可进入并安装沉头螺丝以及弹簧原件

165 iS PZ/S # 1 + 2 扳手套装Kraftform Plus系列100。小直径刀杆



Code	EAN		
05006470001	4013288 214317		1
		+	165 iS PZ/S 1x # 1x80; 1x # 2x100

Kraftform Kompakt VDE 不锈钢 17 超薄 1 工具查找装置

两个 3817 VDE Kraftform 批头夹持螺丝刀, 符合人体工程学, 旋转更舒适。15 个 VDE 可更换刀杆, 有些刀杆缩短了刀杆直径 (iS), 即使难以触及的螺丝和弹簧元件也可触及; 带 "Take it easy": 工具查找装置: 带有侧面彩色编码和激光雕刻尺寸指示 - 以便快捷识别所需的工具。已在 10000 V 下完成独立测试, 可在批准的 1000 V 电压下安全工作。

Wera 的不锈钢工具经过真空冰回火, 因此具备螺丝拧紧所需的硬度和强度。

工业应用不受限制。装在坚固的腰带皮套中。折叠袋在背侧设有弯钩和环扣系统, 适合安装到墙壁、柜子、车间用滚轮小车和 Wera 2go 系统。



Kraftform Kompakt VDE 不锈钢 17 超薄 1 工具查找装置



Code	EAN		
05006631001	4013288 230034		1
		●	3817 VDE Stainless 2x 9x98
		+	Kraftform Kompakt VDE 3062 iS Take it easy 1x PH 1x157; 1x PH 2x157
		+	Kraftform Kompakt VDE 3065 iS PZ Take it easy 1x PZ 1x157; 1x PZ 2x157
		+	Kraftform Kompakt VDE 3065 iS PZ/S Take it easy 1x # 1x157; 1x # 2x157
		+	Kraftform Kompakt VDE 3067 i Take it easy 1x TX 10x157
		+	Kraftform Kompakt VDE 3067 iS Take it easy 1x TX 15x157; 1x TX 20x157; 1x TX 25x157
		●	Kraftform Kompakt VDE 3060 i Take it easy 1x 0,4x2,5x157; 1x 1,2x6,5x157
		●	Kraftform Kompakt VDE 3060 iS Take it easy 1x 0,6x3,5x157; 1x 0,8x4,0x157; 1x 1,0x5,5x157
			魔术贴 70 1x 50,0x70,0

Kraftform Kompakt VDE 不锈钢 8 超薄 1 工具查找装置

一个 3817 VDE Kraftform 批头夹持螺丝刀, 符合人体工程学, 旋拧更舒适。7 个 VDE 可更换刀杆, 有些刀杆缩短了刀杆直径 (iS), 即使难以触及的螺丝和弹簧元件也可触及; 带 "Take it easy": 工具查找装置: 带有侧面彩色编码和激光雕刻尺寸指示 - 以便快捷识别所需的工具。

已在 10000 V 下完成独立测试, 可在批准的 1000 V 电压下安全工作。Wera 的不锈钢工具经过真空冰回火, 因此具备螺丝拧紧所需的硬度和强度。工业应用不受限制。装在坚固的腰带皮套中。

折叠袋在背侧设有弯钩和环扣系统, 适合安装到墙壁、柜子、车间用滚轮小车和 Wera 2go 系统。

Kraftform Kompakt VDE 不锈钢 8 超薄 1 工具查找装置



Code	EAN		
05006630001	4013288 229656		1
		● 3817 VDE 不锈钢 1x 9x98	
		✳ Kraftform Kompakt VDE 3067 i Take it easy 1x TX 8x157; 1x TX 9x157; 1x TX 10x157; 1x TX 30x157	
		✳ Kraftform Kompakt VDE 3067 iS Take it easy 1x TX 15x157; 1x TX 20x157; 1x TX 25x157	
		魔术贴 70 1x 50,0x70,0	

3817 VDE Kraftform 不锈钢刀杆固持手柄 SB

仅用于 Wera VDE 不锈钢刀杆的高级 VDE 批头夹持螺丝刀。手柄/刀杆系统可以快速更换所需的刀杆, 从而实现广泛的应用。

Kraftform Plus 手柄, 符合人体工学设计的旋拧操作舒适, 可避免出现起泡和老茧。硬质手柄区域, 适合较高的操作速度, 软质手柄区域则适用于高扭矩传输。

- Kraftform Kompakt VDE 不锈钢批头夹持手柄
- 光滑的硬质区可在手上快速滑动, 软质抓握区可传递更大扭力

3817 VDE Kraftform 不锈钢刀杆固持手柄 SB



	EAN	mm	mm				
Code	4013288	mm	mm				
05003991001	220189	9	98				1

Kraftform Kompakt VDE 3060 i Take it easy SB · 不锈钢

VDE 不锈钢刀杆用于 Kraftform Kompakt 手柄/刀杆系统, 超快速更换刀杆, 无需特殊工具。根据 IEC 60900 对工具进行单个测试。已在 10000 V 下完成独立测试, 可在批准的 1000 V 电压下安全工作。

Wera 的不锈钢工具经过真空冰硬化, 因此具备螺丝拧紧所需的硬度和强度。工业应用不受限制。

- Kraftform Kompakt VDE 可更换式绝缘刀杆, 用于一字螺丝
- 按照 IEC 60900 的标准, 每件绝缘工具都经过单独测试
- 不锈钢刀杆, 防止外部锈蚀
- 真空冰淬硬化以达到所需要的硬度和强度
- 9 mm 六角驱动, 带倒角
- “Take it easy” 工具查找装置: 带有侧面彩色编码和激光雕刻尺寸指示

Kraftform Kompakt VDE 3060 i Take it easy SB · 不锈钢



Code	EAN			
	4013288			
05006575001	229236	●	Kraftform Kompakt VDE 3060 i Take it easy 1x 0.4x2.5x157	5
05006576001	229243	●	Kraftform Kompakt VDE 3060 i Take it easy 1x 1.2x6.5x157	5

Kraftform Kompakt VDE 3060 iS Take it easy SB · 不锈钢

- 小直径刀杆, 一体式绝缘保护
- 这样即可进入并安装沉头螺丝以及弹簧原件
- “Take it easy” 工具查找装置: 带有侧面彩色编码和激光雕刻尺寸指示



Kraftform Kompakt VDE 3060 iS Take it easy SB · 不锈钢



Code	EAN			
	4013288			
05006577001	229250	●	Kraftform Kompakt VDE 3060 iS Take it easy 1x 0.6x3.5x157	5
05006578001	229274	●	Kraftform Kompakt VDE 3060 iS Take it easy 1x 0.8x4.0x157	5
05006579001	229281	●	Kraftform Kompakt VDE 3060 iS Take it easy 1x 1.0x5.5x157	5

Kraftform Kompakt VDE 3062 iS Take it easy SB · 不锈钢

- 小直径刀杆, 一体式绝缘保护
- 这样即可进入并操作沉头十字螺丝
- “Take it easy” 工具查找装置: 带有侧面彩色编码和激光雕刻尺寸指示

Kraftform Kompakt VDE 3062 iS Take it easy SB · 不锈钢



Code	EAN			
	4013288			
05006580001	229304	+	Kraftform Kompakt VDE 3062 iS Take it easy 1x PH 1x157	5
05006581001	229427	+	Kraftform Kompakt VDE 3062 iS Take it easy 1x PH 2x157	5

Kraftform Kompakt VDE 3065 iS PZ Take it easy SB · 不锈钢 小直径刀杆, 一体式绝缘保护

- 这样即可进入并操作沉头米字螺丝
- “Take it easy” 工具查找装置: 带有侧面彩色编码和激光雕刻尺寸指示

Kraftform Kompakt VDE 3065 iS PZ Take it easy SB · 不锈钢



Code	EAN		
05006582001	229533	+	Kraftform Kompakt VDE 3065 iS PZ Take it easy 1x PZ 1x157
05006583001	229540	+	Kraftform Kompakt VDE 3065 iS PZ Take it easy 1x PZ 2x157

Kraftform Kompakt VDE 3065 iS PZ/S Take it easy · 不锈钢

- 小直径刀杆, 一体式绝缘保护
- 这样即可进入并操作沉头穿心螺丝
- “Take it easy” 工具查找装置: 带有侧面彩色编码和激光雕刻尺寸指示

Kraftform Kompakt VDE 3065 iS PZ/S Take it easy SB · 不锈钢



Code	EAN		
05006584001	229502	+	Kraftform Kompakt VDE 3065 iS PZ/S Take it easy 1x # 1x157
05006585001	229526	+	Kraftform Kompakt VDE 3065 iS PZ/S Take it easy 1x # 2x157

Kraftform Kompakt VDE 3067 iS TORX® Take it easy SB · 不锈钢

- 小直径刀杆, 一体式绝缘保护
- 这样即可进入并操作沉头TORX®梅花螺丝
- “Take it easy” 工具查找装置: 带有侧面彩色编码和激光雕刻尺寸指示

Kraftform Kompakt VDE 3067 iS TORX® Take it easy SB · 不锈钢

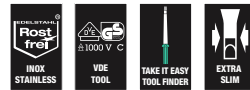

Code	EAN		
05006590001	229472	+	Kraftform Kompakt VDE 3067 iS Take it easy 1x TX 15x157
05006591001	229489	+	Kraftform Kompakt VDE 3067 iS Take it easy 1x TX 20x157
05006592001	229496	+	Kraftform Kompakt VDE 3067 iS Take it easy 1x TX 25x157

Kraftform Kompakt VDE 3067 i TORX® Take it easy SB · 不锈钢

- Kraftform Kompakt VDE可更换式绝缘刀杆, 用于TORX® 梅花螺丝
- “Take it easy” 工具查找装置: 带有侧面彩色编码和激光雕刻尺寸指示

Kraftform Kompakt VDE 3067 i TORX® Take it easy SB · 不锈钢



Code	EAN			
	4013288			
05006586001	229434	☸	Kraftform Kompakt VDE 3067 i Take it easy 1x TX 8x157	5
05006587001	229441	☸	Kraftform Kompakt VDE 3067 i Take it easy 1x TX 9x157	5
05006588001	229458	☸	Kraftform Kompakt VDE 3067 i Take it easy 1x TX 10x157	5
05006589001	229465	☸	Kraftform Kompakt VDE 3067 i Take it easy 1x TX 30x157	5

具有棘轮功能的 837 i RA Kraftform 批头夹持螺丝刀

用于 Wera Kraftform Kompakt VDE 刀杆的批头夹持螺丝刀, 手柄 (40 齿/回转角 9°) 集成细齿棘轮。棘轮加速了旋拧, 而不必重新定位工具。

棘轮机构完全嵌入到手柄中, 确保了非常轻松舒适的工作。手柄/刀杆系统可以快速更换所需的刀杆, 从而实现广泛的应用。

- 具有棘轮功能的 VDE Kraftform 批头夹持螺丝刀
- 细齿集成棘轮保证快速安全工作
- 高工作速度: 旋拧时, 棘轮也可以用来“旋转”
- 符合人体工程学的直观切换到顺时针/逆时针或位置 0
- Kraftform Plus 手柄, 适合舒适的人体工程学工作



具有棘轮功能的 837 i RA Kraftform 批头夹持螺丝刀



Code	EAN	mm	mm					
05057490001	229700	9	115					1

Kraftform Kompakt VDE 17 RA 1

17 件 Kraftform Kompakt VDE 组套。一把带棘轮功能的 837 i RA 批头夹持螺丝刀 (40 齿, 回转角 9°), 一个 817 VDE 批头夹持螺丝刀, 15 个带 “Take it easy” 工具查找装置的 VDE 刀杆: 带有侧面彩色编码和激光雕刻尺寸指示。

根据 IEC 60900 对工具进行单个测试。在 10,000 伏特电压下在水淬中进行单独测试, 确保在 1,000 伏特电压下安全工作。装在坚固的腰带皮套中。

- 一把带棘轮功能的 Kraftform Kompakt VDE Kraftform 837 i RA 的批头夹持螺丝刀 (40 齿, 回转角 9°), 一个用于刀杆的 817 VDE 批头夹持螺丝刀
- 手柄中集成有棘轮的 837 i RA 批头夹持螺丝刀可确保快速安全的工作
- 高工作速度: 旋转时, 棘轮也可以用来“旋转”
- 符合人体工程学的直观切换到顺时针/逆时针或位置 0
- VDE 刀杆 (长 157 mm) 具有实用的旋转功能、防侧倾保护和 “Take it easy” 工具查找装置: 带有侧面彩色编码和激光雕刻尺寸指示
- 根据 IEC 60900 对工具进行单个测试
- 坚固的帆布腰包
- 适用于 Wera 2go

Kraftform Kompakt VDE 17 RA 1



Code	EAN		
05006618001	4013288		1
	229694		
		● 837 i RA 1x 9x115	
		● 817 VDE 1x 9x98	
		⊕ Kraftform Kompakt VDE 62 i Take it easy 1x PH 1x157; 1x PH 2x157	
		⊕ Kraftform Kompakt VDE 65 i Take it easy 1x PZ 1x157; 1x PZ 2x157	
		⊕ Kraftform Kompakt VDE 65 i PZ/S Take it easy 1x # 1x157; 1x # 2x157	
		⊕ Kraftform Kompakt VDE 67 i Take it easy 1x TX 10x157; 1x TX 15x157; 1x TX 20x157; 1x TX 25x157	
		⊖ Kraftform Kompakt VDE 60 i Take it easy 1x 0,4x2,5x157; 1x 0,8x4,0x157; 1x 1,0x5,5x157; 1x 1,2x6,5x157	
		⊖ Kraftform Kompakt VDE 60 iS Take it easy 1x 0,6x3,5x157	

Kraftform Kompakt VDE 17 RA Imperial 1



Code	EAN		
05006619001	4013288		1
	229885		
		● 837 i RA 1x 9x115	
		● 817 VDE 1x 9x98	
		⊕ Kraftform Kompakt VDE 62 i Take it easy 1x PH 1x157; 1x PH 2x157	
		⊕ Kraftform Kompakt VDE 65 i PZ/S Take it easy 1x # 1x157; 1x # 2x157	
		⊕ Kraftform Kompakt VDE 67 i Take it easy 1x TX 10x157; 1x TX 15x157; 1x TX 20x157; 1x TX 25x157	
		⊖ Kraftform Kompakt VDE 60 i Take it easy 1x 0,4x2,5x157; 1x 0,8x4,0x157; 1x 1,0x5,5x157; 1x 1,2x6,5x157	
		⊖ Kraftform Kompakt VDE 60 iS Take it easy 1x 0,6x3,5x157	
		□ Kraftform Kompakt VDE 68 i Take it easy 1x # 1x157; 1x # 2x157	

Kraftform Kompakt Kraftform组合螺丝批套和绝缘型螺丝批套 – 一应俱全

Kraftform Kompakt VDE 16 扭矩 1.2-3.0 Nm 超薄 1 工具查找装置

16 件扭矩 VDE 刀杆组套。含 14 个刀杆 (其中 12 个缩小刀杆直径), 含一体式绝缘防护。

带 “Take it easy” 工具查找装置: 带有侧面彩色编码和激光雕刻尺寸指示 - 以便快捷识别所需的工具。扭矩值可在 1.2-3.0 Nm 范围内调节的扭矩 VDE 批头夹持螺丝刀和 817 VDE 批头夹持螺丝刀。

均带符合人体工学设计的 Kraftform Plus 手柄, 硬质区确保高效作业, 软质区确保高扭矩传输。

Kraftform Kompakt VDE 16 扭矩 1.2-3.0 Nm 超薄 1 工具查找装置



Code	EAN		
05006609001	4013288 229953		1
		7400 VDE 1x 7441 VDE, 1,2-3,0 Nm	
		817 VDE 1x 9x98	
		Kraftform Kompakt VDE 62 iS Take it easy 1x PH 1x157; 1x PH 2x157	
		Kraftform Kompakt VDE 65 iS Take it easy 1x PZ 1x157; 1x PZ 2x157	
		Kraftform Kompakt VDE 65 iS PZ/S Take it easy 1x # 1x157; 1x # 2x157	
		Kraftform Kompakt VDE 67 i Take it easy 1x TX 10x157	
		Kraftform Kompakt VDE 67 iS Take it easy 1x TX 15x157; 1x TX 20x157; 1x TX 25x157	
		Kraftform Kompakt VDE 60 i Take it easy 1x 0,4x2,5x157	
		Kraftform Kompakt VDE 60 iS Take it easy 1x 0,6x3,5x157; 1x 0,8x4,0x157; 1x 1,0x5,5x157	
		魔术贴 70 1x 50,0x70,0	

Kraftform Kompakt VDE 15 扭矩 1.2-3.0 Nm 超薄 1 工具查找装置

15 件扭矩 VDE 刀杆组套。一把扭矩值可在 1.2-3.0 Nm 范围内调节的扭矩 VDE 批头夹持螺丝刀。

带符合人体工学设计的 Kraftform Plus 手柄, 硬质区确保高效作业, 软质区确保高扭矩传输。

含 14 个刀杆 (其中 12 个缩小刀杆直径), 含一体式绝缘防护。

带 “Take it easy” 工具查找装置: 带有侧面彩色编码和激光雕刻尺寸指示 - 以便快捷识别所需的工具。装在坚固的腰带皮套中。

帆布工具袋在背面含成网区。利用所含的自粘钩和环扣带, 帆布袋可以连接至 Wera 2go 组件。

或连接至墙壁、货架或车间手推车。

Kraftform Kompakt VDE 15 扭矩 1.2-3.0 Nm 超薄 1 工具查找装置

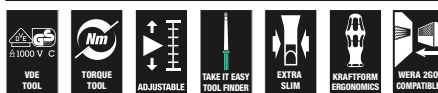

Code	EAN		
05006605001	4013288 229915		1
		7400 VDE 1x 7441 VDE, 1,2-3,0 Nm	
		Kraftform Kompakt VDE 62 iS Take it easy 1x PH 1x157; 1x PH 2x157	
		Kraftform Kompakt VDE 65 iS Take it easy 1x PZ 1x157; 1x PZ 2x157	
		Kraftform Kompakt VDE 65 iS PZ/S Take it easy 1x # 1x157; 1x # 2x157	
		Kraftform Kompakt VDE 67 i Take it easy 1x TX 10x157	
		Kraftform Kompakt VDE 67 iS Take it easy 1x TX 15x157; 1x TX 20x157; 1x TX 25x157	
		Kraftform Kompakt VDE 60 i Take it easy 1x 0,4x2,5x157	
		Kraftform Kompakt VDE 60 iS Take it easy 1x 0,6x3,5x157; 1x 0,8x4,0x157; 1x 1,0x5,5x157	
		魔术贴 70 1x 50,0x70,0	

Kraftform Kompakt VDE Big Pack 1

26 件 Kraftform Kompakt VDE 组套、2 把 817 VDE Kraftform 批头夹持螺丝刀、24 把 VDE 刀杆 (每把长度为 157 mm)，其中大部分刀杆的直径 (iS) 都有所减小，因此即使难以触及的螺丝和弹簧元件也可触及。在 10,000 伏特电压下根据 IEC 60900 进行单独测试，确保在 1,000 伏特电压下安全工作。

“Take it easy” 工具查找装置，根据型面进行颜色编码和尺寸压印标记，可快速方便地找到所需工具。Kraftform Plus 手柄，符合人体工学设计的舒适旋拧操作舒适，可避免出现起泡和老茧。硬质手柄区域，适合较高的操作速度，软质手柄区域则适用于高扭矩传输。防滚动保护，防止批头在工作场所滚动。

- 2 个 VDE 绝缘 Kraftform 817 VDE 批头夹持螺丝刀，带防滚翻保护
- VDE 刀杆 (长 157 mm) 具有实用的旋转功能、防侧倾保护和 “Take it easy” 工具查找装置：带有侧面彩色编码和激光雕刻尺寸指示
- 经绝缘处理的工具，刀片部分采用缩小直径，可在最大 1,000V 电压下安全操作
- 根据 IEC 60900 对工具进行单个测试
- 坚固的帆布腰包装
- 适用于 Wera 2go

Kraftform Kompakt VDE Big Pack 1



Code	EAN		
05006617001	4013288 229557		1
		● 817 VDE 2x 9x98	
		⊕ Kraftform Kompakt VDE 62 iS Take it easy 1x PH 1x157; 1x PH 2x157	
		⊕ Kraftform Kompakt VDE 65 iS Take it easy 1x PZ 1x157; 1x PZ 2x157	
		⊕ Kraftform Kompakt VDE 62 iS PH/S Take it easy 1x # 1x157; 1x # 2x157	
		⊕ Kraftform Kompakt VDE 65 iS PZ/S Take it easy 1x # 1x157; 1x # 2x157	
		⊕ Kraftform Kompakt VDE 67 i Take it easy 1x TX 8x157; 1x TX 9x157; 1x TX 10x157; 1x TX 30x157	
		⊕ Kraftform Kompakt VDE 67 iS Take it easy 1x TX 15x157; 1x TX 20x157; 1x TX 25x157	
		○ Kraftform Kompakt VDE 64 i Take it easy 1x 2,5x157; 1x 3,0x157; 1x 4,0x157; 1x 5,0x157	
		● Kraftform Kompakt VDE 60 i Take it easy 1x 0,4x2,5x157; 1x 1,2x6,5x157	
		● Kraftform Kompakt VDE 60 iS Take it easy 1x 0,6x3,5x157; 1x 0,8x4,0x157; 1x 1,0x5,5x157	

Kraftform Kompakt VDE 18 通用型 1 工具查找装置

一把 817 VDE Kraftform 螺丝刀和 12 个 VDE 刀杆，带“Take it easy”工具查找装置：带有侧面彩色编码和激光雕刻尺寸指示 - 以便快捷识别所需的工具，4 个控制柜钥匙，一个单极相位测试仪。

在 10,000 伏特电压下进行单独测试，确保在 1,000 伏特电压下安全工作。装在坚固的腰带皮套中。帆布工具袋在背面含成网区。

利用所含的自粘钩和环扣带，帆布袋可以连接至 Wera 2go 组件。或连接至墙壁、货架或车间手推车。

- VDE 刀杆 (长 157 mm) 具有实用的旋转功能、防侧倾保护和“Take it easy”工具查找装置：带有侧面彩色编码和激光雕刻尺寸指示

Kraftform Kompakt VDE 18 通用型 1 工具查找装置



Code	EAN		
05006613001	229991		1
		● 817 VDE 1x 9x98	
		⊕ Kraftform Kompakt VDE 62 i Take it easy 1x PH 1x157; 1x PH 2x157	
		⊕ Kraftform Kompakt VDE 65 i Take it easy 1x PZ 1x157; 1x PZ 2x157	
		⊕ Kraftform Kompakt VDE 62 i PH/S Take it easy 1x # 1x157; 1x # 2x157	
		⊕ Kraftform Kompakt VDE 65 i PZ/S Take it easy 1x # 1x157; 1x # 2x157	
		⊖ Kraftform Kompakt VDE 60 i Take it easy 1x 0,4x2,5x157; 1x 0,6x3,5x157; 1x 0,8x4,0x157; 1x 1,0x5,5x157	
		■ Kraftform Kompakt 96 VK 6,3 1x 6,3x89	
		■ Kraftform Kompakt 97 VK 8,1 1x 8,1x89	
		▲ Kraftform Kompakt 98 DK 1x 89	
		● Kraftform Kompakt 99 FL 1x 89	
		⊖ 247 1x 0,5x3,0x70	
		魔术贴 70 1x 50,0x70,0	

7) 未在美国和加拿大上市

Kraftform Kompakt VDE 18 Imperial 1 工具查找装置



Code	EAN		
05006616001	230027		1
		● 817 VDE 2x 9x98	
		⊕ Kraftform Kompakt VDE 62 i Take it easy 1x PH 1x157; 1x PH 2x157	
		⊕ Kraftform Kompakt VDE 62 i PH/S Take it easy 1x # 1x157; 1x # 2x157	
		⊕ Kraftform Kompakt VDE 65 i PZ/S Take it easy 1x # 1x157; 1x # 2x157	
		⊖ Kraftform Kompakt VDE 60 i Take it easy 1x 0,4x2,5x157; 1x 0,6x3,5x157; 1x 0,8x4,0x157; 1x 1,0x5,5x157	
		○ Kraftform Kompakt VDE 68 i Take it easy 1x # 1x157; 1x # 2x157	
		■ Kraftform Kompakt 96 VK 6,3 1x 6,3x89	
		■ Kraftform Kompakt 97 VK 8,1 1x 8,1x89	
		▲ Kraftform Kompakt 98 DK 1x 89	
		● Kraftform Kompakt 99 FL 1x 89	
		魔术贴 70 1x 50,0x70,0	

Kraftform Kompakt VDE 18 通用型 2 工具查找装置



Code	EAN		
05006614001	4013288 230010		1
		● 817 VDE 2x 9x98	
		+ Kraftform Kompakt VDE 62 i Take it easy 1x PH 1x157; 1x PH 2x157	
		+ Kraftform Kompakt VDE 65 i Take it easy 1x PZ 1x157; 1x PZ 2x157	
		+ Kraftform Kompakt VDE 62 i PH/S Take it easy 1x # 1x157; 1x # 2x157	
		+ Kraftform Kompakt VDE 65 i PZ/S Take it easy 1x # 1x157; 1x # 2x157	
		- Kraftform Kompakt VDE 60 i Take it easy 1x 0,4x2,5x157; 1x 0,6x3,5x157; 1x 0,8x4,0x157; 1x 1,0x5,5x157	
		■ Kraftform Kompakt 96 VK 6,3 1x 6,3x89	
		■ Kraftform Kompakt 97 VK 8,1 1x 8,1x89	
		▲ Kraftform Kompakt 98 DK 1x 89	
		● Kraftform Kompakt 99 FL 1x 89	
		魔术贴 70 1x 50,0x70,0	

Kraftform Kompakt VDE 17 超薄 1 工具查找装置

- 经单个测试的VDE可替换型刀杆, 刀片直径更小
- 2个多组件、符合人体工程学原理的Kraftform VDE手柄, 具有防滚动保护功能
- 采用经久耐用的织物收纳用腰包
- 多功能夹钳用于电气安装: 电线切割、剥线、夹紧、弯折、去毛边, 压接芯线端部铁箍
- 夹钳包含电缆剪, 具有精确切割轮缘 (经感应硬化处理) 用于铜线和铝线, 最大规格5 x 2.5mm²/Ø 15 mm
- VDE 刀杆 (长 157 mm) 具有实用的旋转功能、防侧倾保护和“Take it easy”工具查找装置: 带有侧面彩色编码和激光雕刻尺寸指示

Kraftform Kompakt VDE 17 超薄 1 工具查找装置



Code	EAN		
05006612001	4013288 229977		1
		● 817 VDE 2x 9x98	
		+ Kraftform Kompakt VDE 62 iS Take it easy 1x PH 1x157; 1x PH 2x157	
		+ Kraftform Kompakt VDE 65 iS Take it easy 1x PZ 1x157; 1x PZ 2x157	
		+ Kraftform Kompakt VDE 65 iS PZ/S Take it easy 1x # 1x157; 1x # 2x157	
		+ Kraftform Kompakt VDE 67 i Take it easy 1x TX 10x157	
		+ Kraftform Kompakt VDE 67 iS Take it easy 1x TX 15x157; 1x TX 20x157; 1x TX 25x157	
		- Kraftform Kompakt VDE 60 i Take it easy 1x 0,4x2,5x157	
		- Kraftform Kompakt VDE 60 iS Take it easy 1x 0,6x3,5x157; 1x 0,8x4,0x157; 1x 1,0x5,5x157	
		KNIPEX 13 96 200	
		魔术贴 70 1x 50,0x70,0	

Kraftform Kompakt VDE 17 通用型 1 工具查找装置

- 17 件组套
- 2 个 VDE 绝缘 Kraftform 817 VDE 批头夹持螺丝刀, 带防滚翻保护
- VDE 刀杆 (长 157 mm) 具有实用的旋转功能、防侧倾保护和“Take it easy”工具查找装置: 带有侧面彩色编码和激光雕刻尺寸指示
- 根据 IEC 60900 对工具进行单个测试
- 坚固的帆布腰包装
- 可适配 Wera 2go

Kraftform Kompakt VDE 17 通用型 1 工具查找装置



Code	EAN		
05006611001	4013288 229564		1
		● 817 VDE 2x 9x98	
		⊕ Kraftform Kompakt VDE 62 i Take it easy 1x PH 1x157; 1x PH 2x157	
		⊕ Kraftform Kompakt VDE 65 i Take it easy 1x PZ 1x157; 1x PZ 2x157	
		⊕ Kraftform Kompakt VDE 65 i PZ/S Take it easy 1x # 1x157; 1x # 2x157	
		⊕ Kraftform Kompakt VDE 67 i Take it easy 1x TX 10x157; 1x TX 15x157; 1x TX 20x157; 1x TX 25x157	
		● Kraftform Kompakt VDE 60 i Take it easy 1x 0,4x2,5x157; 1x 0,8x4,0x157; 1x 1,0x5,5x157; 1x 1,2x6,5x157	
		● Kraftform Kompakt VDE 60 iS Take it easy 1x 0,6x3,5x157	
		魔术贴 70 1x 50,0x70,0	

Kraftform Kompakt VDE 16 超薄 1 工具查找装置

- 可更换式小直径绝缘刀杆
- 可在狭小空间内拆装螺丝
- 可进入并安装沉头螺丝以及弹簧原件
- VDE 刀杆 (长 157 mm) 具有实用的旋转功能、防侧倾保护和“Take it easy”工具查找装置: 带有侧面彩色编码和激光雕刻尺寸指示

Kraftform Kompakt VDE 16 超薄 1 工具查找装置



Code	EAN		
05006608001	4013288 229946		1
		● 817 VDE 1x 9x98	
		⊕ Kraftform Kompakt VDE 62 iS Take it easy 1x PH 1x157; 1x PH 2x157	
		⊕ Kraftform Kompakt VDE 65 iS Take it easy 1x PZ 1x157; 1x PZ 2x157	
		⊕ Kraftform Kompakt VDE 65 iS PZ/S Take it easy 1x # 1x157; 1x # 2x157	
		⊕ Kraftform Kompakt VDE 67 i Take it easy 1x TX 10x157	
		⊕ Kraftform Kompakt VDE 67 iS Take it easy 1x TX 15x157; 1x TX 20x157; 1x TX 25x157	
		● Kraftform Kompakt VDE 60 i Take it easy 1x 0,4x2,5x157	
		● Kraftform Kompakt VDE 60 iS Take it easy 1x 0,6x3,5x157; 1x 0,8x4,0x157; 1x 1,0x5,5x157	
		● 247 1x 0,5x3,0x70	
		魔术贴 70 1x 50,0x70,0	

⌚ 未在美国和加拿大上市



Kraftform Kompakt VDE 16 通用型 1 工具查找装置



Code	EAN		
05006607001	4013288 229922		1
		● 817 VDE 1x 9x98	
		⊕ Kraftform Kompakt VDE 62 i Take it easy 1x PH 1x157; 1x PH 2x157	
		⊕ Kraftform Kompakt VDE 65 i Take it easy 1x PZ 1x157; 1x PZ 2x157	
		⊕ Kraftform Kompakt VDE 65 i PZ/S Take it easy 1x # 1x157; 1x # 2x157	
		⊕ Kraftform Kompakt VDE 67 i Take it easy 1x TX 10x157; 1x TX 15x157; 1x TX 20x157; 1x TX 25x157	
		● Kraftform Kompakt VDE 60 i Take it easy 1x 0,4x2,5x157; 1x 0,6x3,5x157; 1x 0,8x4,0x157; 1x 1,0x5,5x157	
		● 247 1x 0,5x3,0x70	
		魔术贴 70 1x 50,0x70,0	

⁷ 未在美国和加拿大上市

Kraftform Kompakt VDE 7 超薄 1 工具查找装置

- 经单个测试的VDE可替换型刀杆，刀片直径更小
- 采用经久耐用的折叠袋，兼容 Wera 2go
- VDE 刀杆 (长 157 mm) 具有实用的旋转功能、防侧倾保护和“Take it easy”工具查找装置：带有侧面彩色编码和激光雕刻尺寸指示

Kraftform Kompakt VDE 7 超薄 1 工具查找装置



Code	EAN		
05006603001	4013288 229687		1
		● 817 VDE 1x 9x98	
		⊕ Kraftform Kompakt VDE 62 iS Take it easy 1x PH 1x157; 1x PH 2x157	
		⊕ Kraftform Kompakt VDE 65 iS PZ/S Take it easy 1x # 2x157	
		⊕ Kraftform Kompakt VDE 67 iS Take it easy 1x TX 15x157; 1x TX 20x157	
		● Kraftform Kompakt VDE 60 iS Take it easy 1x 0,6x3,5x157	
		魔术贴 70 1x 50,0x70,0	

Kraftform Kompakt VDE 7 通用型 1 工具查找装置

一把 817 VDE Kraftform 螺丝刀和 6 个 VDE 刀杆，带“Take it easy”工具查找装置：彩色编码和激光雕刻尺寸指示。在 10,000 伏特电压下进行单独测试，确保在 1,000 伏特电压下安全工作。

装在坚固的腰带皮套中。帆布工具袋在背面合成网区。利用所含的自粘钩和环扣带，帆布袋可以连接至 Wera 2go 组件。或连接至墙壁、货架或车间手推车。

- VDE 刀杆 (长 157 mm) 具有实用的旋转功能、防侧倾保护和“Take it easy”工具查找装置：带有侧面彩色编码和激光雕刻尺寸指示

Kraftform Kompakt VDE 7 通用型 1 工具查找装置



Code	EAN			
0500660001	4013288 229663			1
		●	817 VDE 1x 9x98	
		+	Kraftform Kompakt VDE 62 i Take it easy 1x PH 1x157; 1x PH 2x157	
		-	Kraftform Kompakt VDE 60 i Take it easy 1x 0,4x2,5x157; 1x 0,6x3,5x157; 1x 0,8x4,0x157; 1x 1,0x5,5x157	
			魔术贴 70 1x 50,0x70,0	

Kraftform Kompakt VDE 7 Imperial 1 工具查找装置



Code	EAN			
05006604001	4013288 229892			1
		●	817 VDE 1x 9x98	
		+	Kraftform Kompakt VDE 62 i Take it easy 1x PH 1x157; 1x PH 2x157	
		-	Kraftform Kompakt VDE 60 i Take it easy 1x 0,6x3,5x157; 1x 1,0x5,5x157	
		□	Kraftform Kompakt VDE 68 i Take it easy 1x # 1x157; 1x # 2x157	
			魔术贴 70 1x 50,0x70,0	

Kraftform Kompakt VDE 7 通用型 2 工具查找装置



Code	EAN			
05006601001	4013288 229670			1
		●	817 VDE 1x 9x98	
		+	Kraftform Kompakt VDE 65 i Take it easy 1x PZ 1x157; 1x PZ 2x157	
		-	Kraftform Kompakt VDE 60 i Take it easy 1x 0,4x2,5x157; 1x 0,6x3,5x157; 1x 0,8x4,0x157; 1x 1,0x5,5x157	
			魔术贴 70 1x 50,0x70,0	

7400 系列 Kraftform VDE 可调式绝缘扭矩手柄 (0.3-3.5 Nm)

- Kraftform可调式绝缘扭矩螺丝刀手柄
- 可调扭矩范围: 0.3-1.2
- 达到设定扭矩数值时可听到清晰的超负荷信号
- 适用于Kraftform Kompakt VDE绝缘刀杆
- 可更换式刀杆可以实现快速换装

7400 系列 Kraftform VDE 可调式绝缘扭矩手柄 (0.3-3.5 Nm)



Code	EAN	Art.No.	mm	Nm	Nm	mm		
05074752001	179111	7440 VDE	9	0,3-1,2	0,05	192	7 ⁹ / ₁₆ "	1
05074750001	168535	7441 VDE	9	1,2-3,0	0,10	192	7 ⁹ / ₁₆ "	1
05074757001	184412	7444 VDE	9	1,7-3,5	0,10	192	7 ⁹ / ₁₆ "	1

Kraftform Kompakt Turbo i 1 工具查找装置

许多用户希望在不妥协的情况下更快地执行旋拧操作。使用精确的螺丝刀，允许强力的末端旋拧，并且比传统螺丝刀快得多。解决方案是：可开关行星传动：它集成在手柄中，可将光滑联轴器的的工作速度提高四倍。一只手握住手柄的前部，另一只手转动手柄的后部。涡轮增压功能可一键开启或关闭。

关闭可用于高扭矩松紧作业或精密调节。涡轮增压功能停用后，坚固的免维护钢制驱动装置的最大扭矩为 14 Nm。在 VDE 版本中，827 T i Kraftform Turbo 批头夹持螺丝刀带有按照 IEC 60900 标准单独测试的 Wera VDE 刀杆，即使在张力下（高达 1,000 伏）也能确保快速安全地工作。

带“Take it easy”工具查找装置的 VDE 刀杆：带有侧面彩色编码和激光雕刻尺寸指示 - 以便快捷识别所需的工具。装在坚固的腰带皮套中。帆布工具袋在背面合成网区。利用所含的自粘钩和环扣带，帆布袋可以连接至 Wera 2go 组件。或连接至墙壁、货架或车间手推车。

- 不需要电池，只使用人力（手）驱动下作业下可瞬间提高转动速度四倍的插换式螺丝刀柄（公制）
- 按下按钮启动和关闭 Turbo 功能
- 涡轮增压功能，特别用于精密咬合链接工件
- 可在没有涡轮增压功能的情况下作为常规螺丝刀使用，用于连接件，含稳步增加扭矩
- 零维护的金属耐用齿轮

Kraftform Kompakt Turbo i 1 工具查找装置



Code	EAN			
	4013288			
05006640001	230041			1
			827 T Kraftform Turbo 1x 9x125	
			817 VDE 1x 9x98	
			Kraftform Kompakt VDE 62 iS Take it easy 1x PH 1x157; 1x PH 2x157	
			Kraftform Kompakt VDE 65 iS Take it easy 1x PZ 1x157; 1x PZ 2x157	
			Kraftform Kompakt VDE 65 iS PZ/S Take it easy 1x # 1x157; 1x # 2x157	
			Kraftform Kompakt VDE 67 i Take it easy 1x TX 10x157	
			Kraftform Kompakt VDE 67 iS Take it easy 1x TX 15x157; 1x TX 20x157; 1x TX 25x157	
			Kraftform Kompakt VDE 60 i Take it easy 1x 0,4x2,5x157	
			Kraftform Kompakt VDE 60 iS Take it easy 1x 0,6x3,5x157; 1x 0,8x4,0x157; 1x 1,0x5,5x157	
			魔术贴 120 1x 50,0x120,0	

817 VDE Kraftform 绝缘刀杆夹持手柄

- Kraftform Kompakt VDE Kraftform手柄
- 仅用于维拉可更换式绝缘刀杆
- 光滑的硬质区可在手上快速滑动，软质抓握区可传递更大扭力
- 六角防滚动保护，防止螺丝刀的滚动

817 VDE Kraftform 绝缘刀杆夹持手柄



Code	EAN								
	4013288	mm	mm						
05003990001	104359	9	102						1

Kraftform Kompakt Turbo i Imperial 1 工具查找装置



Code	EAN						
05006641001	4013288 230058						1
		●	827 T Kraftform Turbo 1x 9x125				
		●	817 VDE 1x 9x98				
		+	Kraftform Kompakt VDE 62 iS Take it easy 1x PH 1x157; 1x PH 2x157				
		+	Kraftform Kompakt VDE 62 iS PH/S Take it easy 1x # 1x157; 1x # 2x157				
		+	Kraftform Kompakt VDE 67 i Take it easy 1x TX 10x157				
		+	Kraftform Kompakt VDE 67 iS Take it easy 1x TX 15x157; 1x TX 20x157; 1x TX 25x157				
		●	Kraftform Kompakt VDE 60 i Take it easy 1x 0,4x2,5x157				
		●	Kraftform Kompakt VDE 60 iS Take it easy 1x 0,6x3,5x157; 1x 0,8x4,0x157; 1x 1,0x5,5x157				
		○	Kraftform Kompakt VDE 68 iS Take it easy 1x # 1x157; 1x # 2x157				
			魔术贴 120 1x 50,0x120,0				

827 T i Kraftform Turbo 纯机械式螺丝刀柄

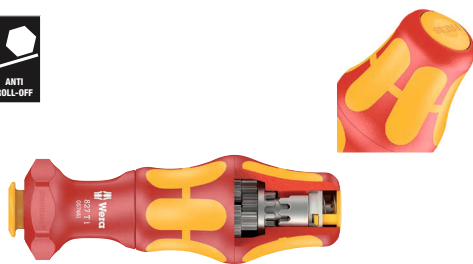

Code	EAN	mm	mm				
05057481001	4013288 214607	9	125				1

Kraftform Kompakt VDE 60 i Take it easy

用于Kraftform Kompakt电设手柄/可插换系统的电设用刀杆, 无需任何其他工具即可快速更换刀杆。根据IEC 60900进行绝缘测试。在10,000伏特下进行个别测试, 确保在1,000伏特电压条件下的安全作业。

- “Take it easy” 工具查找装置: 带有侧面彩色编码和激光雕刻尺寸指示



Kraftform Kompakt VDE 60 i Take it easy

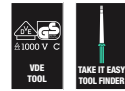

Code	EAN	mm	mm	mm	mm	mm	
05006500001	228420	0,4	2,5	157	3/32"	6 3/16"	5
05006501001	228437	0,5	3,0	157	1/8"	6 3/16"	5
05006502001	228444	0,6	3,5	157	9/64"	6 3/16"	5
05006503001	228451	0,8	4,0	157	5/32"	6 3/16"	5
05006504001	228468	1,0	5,5	157	7/32"	6 3/16"	5
05006505001	228475	1,2	6,5	157	1/4"	6 3/16"	5

Kraftform Kompakt VDE 60 i Take it easy SB



Code	EAN						
05006550001	228925	●	Kraftform Kompakt VDE 60 i Take it easy 1x 0.4x2.5x157				5
05006551001	228932	●	Kraftform Kompakt VDE 60 i Take it easy 1x 0.5x3.0x157				5
05006552001	229007	●	Kraftform Kompakt VDE 60 i Take it easy 1x 0.6x3.5x157				5
05006553001	229014	●	Kraftform Kompakt VDE 60 i Take it easy 1x 0.8x4.0x157				5
05006554001	229021	●	Kraftform Kompakt VDE 60 i Take it easy 1x 1.0x5.5x157				5
05006555001	229038	●	Kraftform Kompakt VDE 60 i Take it easy 1x 1.2x6.5x157				5

Kraftform Kompakt VDE 60 iS Take it easy

- 小直径刀杆, 一体式绝缘保护
- 可在狭小空间内拆装螺丝
- 可进入并安装沉头螺丝以及弹簧原件
- “Take it easy” 工具查找装置: 带有侧面彩色编码和激光雕刻尺寸指示

Kraftform Kompakt VDE 60 iS Take it easy



	EAN	刀尖直径	刀杆直径	刀杆长度	刀尖长度	刀尖宽度	包装
Code	4013288	mm	mm	mm			
05006506001	228482	0,6	3,5	157	9/64"	6 3/16"	5
05006507001	228499	0,8	4,0	157	5/32"	6 3/16"	5
05006508001	228505	1,0	5,5	157	7/32"	6 3/16"	5

Kraftform Kompakt VDE 60 iS Take it easy SB



Code	EAN	描述	包装
Code	4013288		
05006556001	229045	➔ Kraftform Kompakt VDE 60 iS Take it easy 1x 0.6x3.5x157	5
05006557001	229052	➔ Kraftform Kompakt VDE 60 iS Take it easy 1x 0.8x4.0x157	5
05006558001	229069	➔ Kraftform Kompakt VDE 60 iS Take it easy 1x 1.0x5.5x157	5

Kraftform Kompakt VDE 62 i Take it easy



	EAN	刀尖类型	刀尖直径	刀杆长度	刀尖宽度	包装
Code	4013288		mm			
05006509001	228512	PH 0	157	6 3/16"		5
05006510001	228529	PH 1	157	6 3/16"		5
05006511001	228536	PH 2	157	6 3/16"		5

Kraftform Kompakt VDE 62 iS Take it easy

- 小直径刀杆, 一体式绝缘保护
- 可在狭小空间内拆装螺丝
- 可进入并安装沉头螺丝以及弹簧原件
- “Take it easy” 工具查找装置: 带有侧面彩色编码和激光雕刻尺寸指示

Kraftform Kompakt VDE 62 iS Take it easy



	EAN	刀尖类型	刀尖直径	刀杆长度	刀尖宽度	包装
Code	4013288		mm			
05006512001	228543	PH 1	157	6 3/16"		5
05006513001	228550	PH 2	157	6 3/16"		5

Kraftform Kompakt VDE 62 iS Take it easy SB



Code	EAN	描述	包装
Code	4013288		
05006559001	229076	➔ Kraftform Kompakt VDE 62 iS Take it easy 1x PH 1x157	5
05006560001	229083	➔ Kraftform Kompakt VDE 62 iS Take it easy 1x PH 2x157	5

Kraftform Kompakt VDE 65 i Take it easy



	EAN	刀尖类型	刀尖直径	刀杆长度	刀尖宽度	包装
Code	4013288		mm			
05006523001	228659	PZ 0	157	6 3/16"		5
05006524001	228666	PZ 1	157	6 3/16"		5
05006525001	228673	PZ 2	157	6 3/16"		5

Kraftform Kompakt VDE 65 iS Take it easy

- 小直径刀杆，一体式绝缘保护
- 可在狭小空间内拆装螺丝
- 可进入并安装沉头螺丝以及弹簧原件
- “Take it easy” 工具查找装置：带有侧面彩色编码和激光雕刻尺寸指示

Kraftform Kompakt VDE 65 iS Take it easy

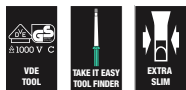

	EAN					
Code	4013288		mm			
05006526001	228680	PZ 1	157	6 3/16"		5
05006527001	228697	PZ 2	157	6 3/16"		5

Kraftform Kompakt VDE 65 iS Take it easy SB

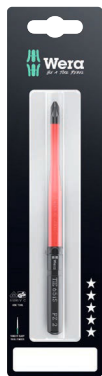

Code	EAN			
	4013288			
05006566001	229212		Kraftform Kompakt VDE 65 iS Take it easy 1x PZ 1x157	5
05006567001	229229		Kraftform Kompakt VDE 65 iS Take it easy 1x PZ 2x157	5

Kraftform Kompakt VDE 62 i PH/S Take it easy

- Kraftform Kompakt VDE可更换式绝缘刀杆，用于穿心十字螺丝
- 特别适用于端子盒、保险丝盒、开关和继电器内的作业
- “Take it easy” 工具查找装置：带有侧面彩色编码和激光雕刻尺寸指示

Kraftform Kompakt VDE 62 i PH/S Take it easy



	EAN					
Code	4013288		mm			
05006514001	228567	# 1	157	6 3/16"		5
05006515001	228574	# 2	157	6 3/16"		5

Kraftform Kompakt VDE 62 iS PH/S Take it easy

- Kraftform Kompakt VDE可更换式绝缘刀杆，用于穿心十字螺丝
- 小直径刀杆，一体式绝缘保护
- 可在狭小空间内拆装螺丝
- 可进入并安装沉头螺丝以及弹簧原件
- “Take it easy” 工具查找装置：带有侧面彩色编码和激光雕刻尺寸指示

Kraftform Kompakt VDE 62 iS PH/S Take it easy

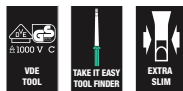

	EAN					
Code	4013288		mm			
05006516001	228581	# 1	157	6 3/16"		5
05006517001	228598	# 2	157	6 3/16"		5

Kraftform Kompakt VDE 65 i PZ/S Take it easy

- 用于穿心米字螺丝
- 特别适用于端子盒、保险丝盒、开关和继电器内的作业
- “Take it easy” 工具查找装置：带有侧面彩色编码和激光雕刻尺寸指示

Kraftform Kompakt VDE 65 i PZ/S Take it easy



	EAN					
Code	4013288		mm			
05006528001	228703	# 1	157	6 3/16"		5
05006529001	228710	# 2	157	6 3/16"		5

Kraftform Kompakt VDE 65 iS PZ/S Take it easy

- 用于穿心米字螺丝
- 小直径刀杆, 一体式绝缘保护
- 可在狭小空间内拆装螺丝
- 可进入并安装沉头螺丝以及弹簧原件
- “Take it easy” 工具查找装置: 带有侧面彩色编码和激光雕刻尺寸指示

Kraftform Kompakt VDE 65 iS PZ/S Take it easy



	EAN						
Code	4013288		mm				
05006530001	228727	# 1	157	6 3/16"			5
05006531001	228734	# 2	157	6 3/16"			5

Kraftform Kompakt VDE 65 iS PZ/S Take it easy SB



Code	EAN				
05006568001	229199		Kraftform Kompakt VDE 65 i PZ/S Take it easy	1x # 1x157	5
05006569001	229205		Kraftform Kompakt VDE 65 iS PZ/S Take it easy	1x # 2x157	5

Kraftform Kompakt VDE 67 i TORX® Take it easy

- Kraftform Kompakt VDE可更换式绝缘刀杆, 用于TORX® 梅花螺丝
- “Take it easy” 工具查找装置: 带有侧面彩色编码和激光雕刻尺寸指示

Kraftform Kompakt VDE 67 i TORX® Take it easy



	EAN						
Code	4013288		mm				
05006532001	228758	TX 8	157	6 3/16"			5
05006533001	228765	TX 9	157	6 3/16"			5
05006534001	228772	TX 10	157	6 3/16"			5
05006535001	228789	TX 15	157	6 3/16"			5
05006536001	228796	TX 20	157	6 3/16"			5
05006537001	228802	TX 25	157	6 3/16"			5
05006538001	228819	TX 27	157	6 3/16"			5
05006539001	228826	TX 30	157	6 3/16"			5

Kraftform Kompakt VDE 67 i TORX® Take it easy SB



Code	EAN				
05006570001	229151		Kraftform Kompakt VDE 67 i Take it easy	1x TX 10x157	5
05006571001	229144		Kraftform Kompakt VDE 67 i Take it easy	1x TX 15x157	5
05006572001	229168		Kraftform Kompakt VDE 67 i Take it easy	1x TX 20x157	5
05006573001	229175		Kraftform Kompakt VDE 67 i Take it easy	1x TX 25x157	5
05006574001	229182		Kraftform Kompakt VDE 67 i Take it easy	1x TX 30x157	5

Kraftform Kompakt VDE 67 iS TORX® Take it easy

- 小直径刀杆，一体式绝缘保护
- 可在狭小空间内拆装螺丝
- 可进入并安装沉头螺丝以及弹簧原件
- “Take it easy” 工具查找装置：带有侧面彩色编码和激光雕刻尺寸指示

Kraftform Kompakt VDE 67 iS TORX® Take it easy



	EAN					
Code	4013288		mm			
05006540001	228833	TX 15	157	6 3/16"		5
05006541001	228840	TX 20	157	6 3/16"		5
05006542001	228857	TX 25	157	6 3/16"		5

Kraftform Kompakt VDE 68 i Take it easy



	EAN					
Code	4013288		mm			
05006543001	228864	# 1	157	6 3/16"		5
05006544001	228871	# 2	157	6 3/16"		5

Kraftform Kompakt VDE 68 iS Take it easy

- 小直径刀杆，一体式绝缘保护
- 可在狭小空间内拆装螺丝
- 可进入并安装沉头螺丝以及弹簧原件
- “Take it easy” 工具查找装置：带有侧面彩色编码和激光雕刻尺寸指示

Kraftform Kompakt VDE 68 iS Take it easy



	EAN					
Code	4013288		mm			
05006545001	228888	# 1	157	6 3/16"		5
05006546001	228895	# 2	157	6 3/16"		5

Kraftform Kompakt VDE 64 i Take it easy

- Kraftform Kompakt VDE可更换式绝缘刀杆，用于内六角螺丝
- 内六角外形（防止内六角螺丝转动圆柱）
- “Take it easy” 工具查找装置：带有侧面彩色编码和激光雕刻尺寸指示



Kraftform Kompakt VDE 64 i Take it easy



	EAN					
Code	4013288		mm	mm		
05006518001	228604	2,5	157	6 3/16"		5
05006519001	228611	3,0	157	6 3/16"		5
05006520001	228628	4,0	157	6 3/16"		5
05006521001	228635	5,0	157	6 3/16"		5
05006522001	228642	6,0	157	6 3/16"		5

Kraftform Kompakt VDE 64 i Take it easy SB

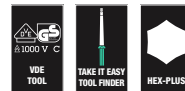

Code	EAN			
	4013288			
05006561001	229090		Kraftform Kompakt VDE 64 i Take it easy 1x 2.5x157	5
05006562001	229106		Kraftform Kompakt VDE 64 i Take it easy 1x 3.0x157	5
05006563001	229113		Kraftform Kompakt VDE 64 i Take it easy 1x 4.0x157	5
05006564001	229120		Kraftform Kompakt VDE 64 i Take it easy 1x 5.0x157	5
05006565001	229137		Kraftform Kompakt VDE 64 i Take it easy 1x 6.0x157	5

KK 96 VK 6,3 控制柜钥匙

控制柜钥匙, 玻璃纤维增强复合材料。适用于7400 VDE 817和VDE Kraftform绝缘刀杆夹持手柄 827 T i Kraftform Turbo。

KK 96 VK 6,3 控制柜钥匙



	EAN							
Code	4013288	mm	mm					
05003460001	105349	6,3	89	3 9/16"				5

KK 97 VK 8,1 控制柜钥匙

- Kraftform Kompakt 8.1mm控制柜钥匙

KK 97 VK 8,1 控制柜钥匙



	EAN							
Code	4013288	mm	mm					
05003461001	105370	8,1	89	3 9/16"				5

KK 98 DK 控制柜钥匙



	EAN							
Code	4013288		mm					
05003462001	105356		89	3 9/16"				5

KK 99 FL 控制柜钥匙



	EAN							
Code	4013288		mm					
05003463001	105363		89	3 9/16"				5

Kraftform - 1000 VDE 绝缘系列

优质 Kraftform 电设用 螺丝刀。Kraftform 多重材料手柄, 可快速拆装螺丝, 降低疲劳。维拉 黑色刀头和精密的硬化工艺提高耐用度、抗腐蚀性和尺寸精度。

在 10,000 伏特电压下进行个别测试, 确保在 1,000 伏特电压下安全作业。六角防滚动设计, 防止螺丝刀的滚动。标记手柄以轻松查找和分类管理工具。

- 经VDE绝缘处理的螺丝刀, 可在最大1,000伏电压下安全操作
- 每一只都经过单独的水浴测试
- Kraftform多重材料手柄, 可快速作业, 降低疲劳程度
- 手柄上的标识方便了工具的寻找和分类
- 维拉黑色刀头, 可精确配合, 具有最佳的抗腐蚀性

1060 i 电设用 绝缘 Kraftform 一字螺丝刀



	EAN							
Code	4013288	mm	mm	mm	mm			
05051580001	222268	0,4	2,5	80	81	3/32"	3 1/8"	10
05051582001	222275	0,6	3,5	100	81	9/64"	4"	10
05051583001	222282	0,8	4,0	100	98	5/32"	4"	10
05051587001	222299	1,0	5,5	125	98	7/32"	5"	10

1062 i 十字 电设用 绝缘 Kraftform 十字螺丝刀



	EAN	+	mm	mm	mm		
Code	4013288						
05051601001	222220	PH 1	80	98	3 1/8"		5
05051603001	222237	PH 2	100	105	4"		5

1065 i PZ 电设用 绝缘 Kraftform 十字螺丝刀



	EAN	*	mm	mm	mm		
Code	4013288						
05051611001	222244	PZ 1	80	98	3 1/8"		5
05051613001	222251	PZ 2	100	105	4"		5

1060 i/1062 i/6 Kraftform 电设用 螺丝刀组套

优质 Kraftform 电设用 螺丝刀组套。Kraftform 多重材料手柄,可快速拆装螺丝,降低疲劳。维拉 黑色刀头和精密的硬化工艺提高耐用度、抗腐蚀性和尺寸精度。

在 10,000 伏特电压下进行个别测试,确保在 1,000 伏特电压下安全作业。六角防滚动设计,防止螺丝刀的滚动。标记手柄以轻松查找和分类管理工具。



1060 i/1062 i/6 Kraftform 电设用 螺丝刀组套



Code	EAN		
	4013288		
05051575001	222381		1
		+	1062 i PH VDE 1x PH 1x80; 1x PH 2x100
		⊖	1060 i VDE 1x 0,4x2,5x80; 1x 0,6x3,5x100; 1x 0,8x4,0x100; 1x 1,0x5,5x125

1060 i/1065 i/6 Kraftform 电设用 螺丝刀组套



Code	EAN		
	4013288		
05051576001	222374		1
		+	1065 i PZ VDE 1x PZ 1x80; 1x PZ 2x100
		⊖	1060 i VDE 1x 0,4x2,5x80; 1x 0,6x3,5x100; 1x 0,8x4,0x100; 1x 1,0x5,5x125

410 i 电设用 B 电设用 绝缘 T 型柄螺丝刀适配器 · 用于 3/8" 套筒

T 型柄的形状允许传递极高的拧紧和松开扭矩。手柄的几何形状完美贴合手掌，手指手掌皆能完美贴合握柄曲线。确保传递符合人体工程学。

按照 IEC 60900 标准在 10,000 伏特电压下进行个别测试，确保在 1,000 伏特电压下安全作业。

仅适用于 维拉 Zyklop 电设用系列 8740、8760、8767、8790 的 3/8" 电设用 批头套筒和套筒。手柄涂层可保护敏感表面不受损。

- 3/8" 电设用 T 型柄螺丝刀允许传递极高的拧紧和松开扭矩
- 二重材质 T 型柄符合人体工程学，手指舒适贴合握柄下凹处，可确保传递极高的扭矩，操作不易产生疲劳感
- 绝缘，根据 IEC 60900 个别测试，确保在 1,000 伏特电压下安全作业
- 仅适用于 维拉 Zyklop 电设用系列 8740、8760、8767、8790 的 3/8" 电设用 批头套筒和套筒

410 i 电设用 B 电设用 绝缘 T 型柄螺丝刀适配器 · 用于 3/8" 套筒

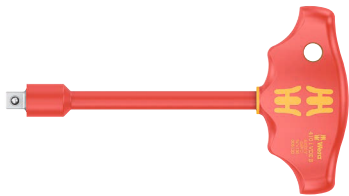

	EAN						
Code	4013288		mm	mm	mm		
05005120001	222664	3/8"	130	49	99	5 1/8"	1

8100 SB VDE 1 Zyklop 绝缘棘轮扳手套组 · 换向拨杆 · 3/8" 驱动 · 公制

极为紧凑的套装，可在有限空间内存放更多工具。每件棘轮扳手、套筒和延长杆都经过 10,000 伏绝缘性能测试，满足 IEC 60900 标准，确保在 1,000 伏电压下的安全作业。极为坚固耐用的织物包可竖直放置于车间架子上。

织物包可为工具提供表面防护。轻便便携。平滑的旋转设计，使绝缘套筒安全储存、便于移除。

- 绝缘，每件棘轮扳手、套筒和延长杆都经过绝缘性能测试，确保在 1,000 伏电压下的安全作业
- 80 细齿，小至 4.5° 的回转角
- 超薄型设计，手柄柔软，带人体工程学设计，方便在狭小空间作业
- 坚固的紧凑型织物包，带套筒座，可安全保存套筒，转动便可取出使用
- 坚固的织布包装，可以和 Wera 2go 系列配合使用

8100 SB VDE 1 Zyklop 绝缘棘轮扳手套组 · 换向拨杆 · 3/8" 驱动 · 公制



	Code	EAN	
		4013288	
	05004970001	190970	1
		8007 B VDE 1x 3/8"x222,0	
		8790 B VDE 1x 6,0x46,0; 1x 7,0x46,0; 1x 8,0x46,0; 1x 9,0x46,0; 1x 10,0x46,0; 1x 11,0x46,0; 1x 12,0x46,0; 1x 13,0x46,0; 1x 14,0x46,0; 1x 15,0x46,0; 1x 16,0x46,0; 1x 17,0x46,0; 1x 18,0x46,0; 1x 19,0x46,0	
		8794 SB VDE 1x 3/8"x91,0	
		8794 LB VDE 1x 3/8"x166,0	

工具带Zyklop套筒组件 六角套筒，经绝缘处理，具有固持功能， $\frac{3}{8}$ "驱动

10个Zyklop套筒，带 $\frac{3}{8}$ "驱动，经VDE绝缘处理，根据IEC 60900进行了个别测试。采用双组件绝缘，安全性能更高，其中黄色VDE绝缘内芯位于红色VDE绝缘外层下方，可在外层红色VDE绝缘层出现损坏时则清晰可见。具有适用于符合Acument知识产权规范的TORX®螺丝，或用于内六角套筒螺钉的固持功能。

牢固耐用的织物工具带，采用典型的Wera设计，在紧凑的空间内放置10个VDE批头套筒。顺滑的旋转扣，可确保稳固的夹持效果，同时方便取下套筒。随附用于连接到腰带或工具包的吊钩。

采用纤维网底面以及弯钩和环扣带，安装方便，例如可黏附在墙壁、置物架、车间工具车以及Wera 2go工具携带系列。

VDE $\frac{3}{8}$ "英寸批头套筒，带固持功能，可实现尤为舒适的旋拧操作，在送至组件时可降低螺螺丝遗失风险。采用黄色VDE绝缘内芯，安全性能更高，可在外层红色VDE绝缘层出现损坏时清晰可见。

根据IEC 60900标准在10,000 V条件下进行了个别测试，可采用经认可的1,000 V条件下安全操作。

- 10件装的 $\frac{3}{8}$ "套筒组件，采用牢固耐用的织物带
- 平滑的拧开解锁设计使得套筒的保存更安全，使用更方便
- 长度极短且设计紧凑的VDE $\frac{3}{8}$ "批头套筒，即便在狭小空间，也可实现方便的操作
- 固持功能确保螺丝牢固黏着在工具上
- 根据IEC 60900标准在10,000 V条件下进行了个别测试，可在最高1,000 V条件下安全操作
- 可附着到墙壁、架子、工具车和维拉2go系列产品上

工具带Zyklop套筒组件 六角套筒，经绝缘处理，具有固持功能， $\frac{3}{8}$ "驱动



	Code	EAN		
	05004930001	4013288 210234		1
		8767 B VDE HF		
		1x TX 20x55,0; 1x TX 25x55,0; 1x TX 27x55,0; 1x TX 30x55,0; 1x TX 40x55,0; 1x TX 45x59,0		
		8740 B VDE HF		
		1x 4,0x55,0; 1x 5,0x55,0; 1x 6,0x55,0; 1x 8,0x59,0		
		Belt B VDE 0/10		
		1x 71,0x209,0		
		K30		
		1x 30,0x200,0		

8007 B VDE Zyklop绝缘棘轮扳手·带换向拨杆， $\frac{3}{8}$ "驱动

- 绝缘，每件Zyklop绝缘棘轮扳手都经过绝缘测试，可在1,000伏电压下安全作业
- 80细齿，小至4.5°的回转角
- 超薄型设计，手柄柔软，带人体工程学设计，方便在狭小空间作业
- 通过按钮安全锁住套筒，换向拨杆，方便换向
- 热塑镀膜表面防护

8007 B VDE Zyklop绝缘棘轮扳手·带换向拨杆， $\frac{3}{8}$ "驱动

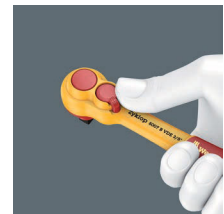

	EAN						
Code	4013288 190963	$\frac{3}{8}$ "	mm				3
05004966001	190963	$\frac{3}{8}$ "	222,0				

8790 B VDE Zyklop 3/8"绝缘套筒

- 每件产品都经过10,000伏绝缘性能测试, 满足IEC 60900标准
- 红色绝缘外层下带双层黄色绝缘内芯, 具有更高的安全性
- 热塑镀膜表面防护

8790 B VDE Zyklop 3/8"绝缘套筒



	EAN						
Code	4013288	mm	mm	mm	mm		
05004950001	192936	6,0	46,0	14,8	23,0		1
05004951001	192943	7,0	46,0	15,7	23,0		1
05004952001	192950	8,0	46,0	17,0	23,0		1
05004953001	192967	9,0	46,0	18,2	23,0		1
05004954001	192974	10,0	46,0	19,4	23,0		1
05004955001	192981	11,0	46,0	20,7	23,0		1
05004956001	192998	12,0	46,0	23,0	23,0		1
05004957001	193001	13,0	46,0	23,0	23,0		1
05004958001	193018	14,0	46,0	24,7	23,0		1
05004959001	193025	15,0	46,0	26,0	23,0		1
05004960001	193032	16,0	46,0	26,8	23,0		1
05004961001	193049	17,0	46,0	29,0	23,0		1
05004962001	193056	18,0	46,0	29,6	23,0		1
05004963001	193063	19,0	46,0	30,7	23,0		1

8767 B VDE HF TORX® Zyklop 绝缘套筒 · 3/8"; 驱动 · 带固持功能

- 固持功能确保螺丝牢固黏着在工具上
- 长度极短且设计紧凑的VDE 3/8"批头套筒, 即便在狭小空间, 也可实现方便的操作

8767 B VDE HF TORX® Zyklop 绝缘套筒 · 3/8" 驱动 · 带固持功能



	EAN						
Code	4013288		mm	mm	mm		
05004920001	210173	TX 20	55,0	23,0	9,0		1
05004921001	210180	TX 25	55,0	23,0	9,0		1
05004922001	210197	TX 27	55,0	23,0	9,0		1
05004923001	210203	TX 30	55,0	23,0	9,0		1
05004924001	210210	TX 40	55,0	23,0	9,0		1
05004925001	210227	TX 45	59,0	23,0	13,0		1

8740 B VDE HF Zyklop 套筒 · 3/8" 驱动 · 带固持功能

- 固持功能确保螺丝牢固黏着在工具上
- 长度极短且设计紧凑的VDE 3/8"批头套筒, 即便在狭小空间, 也可实现方便的操作

8740 B VDE HF Zyklop 套筒 · 3/8" 驱动 · 带固持功能



	EAN						
Code	4013288	mm	mm	mm	mm		
05004900001	210135	4,0	55,0	23,0	9,0		1
05004901001	210142	5,0	55,0	23,0	9,0		1
05004902001	210159	6,0	55,0	23,0	9,0		1
05004903001	210166	8,0	59,0	23,0	13,0		1

8760 B VDE XZN Zyklop 套筒 · 3/8" 驱动 · 用于XZN花键螺丝

- 长度极短且设计紧凑的VDE 3/8"批头套筒, 即便在狭小空间, 也可实现方便的操作

8760 B VDE XZN Zyklop 套筒 · 3/8" 驱动 · 用于XZN花键螺丝



	EAN						
Code	4013288		mm	mm	mm		
05004940001	211453	M 8	59,0	23,0	13,0		1
05004941001	211460	M 10	59,0	23,0	13,0		1
05004942001	211477	M 12	59,0	23,0	13,0		1

8794 LB VDE Zyklop绝缘延长杆 · 长款 · 3/8"

- 3/8" VDE Zyklop绝缘延长杆
- 每件产品都经过10,000伏绝缘性能测试, 满足IEC 60900标准
- 红色绝缘外层下带双层黄色绝缘内芯, 具有更高的安全性
- 热塑镀膜表面防护
- 长款

8794 LB VDE Zyklop绝缘延长杆 · 长款 · 3/8"



	EAN	□	⏏							
Code	4013288	□	⏏	mm						
05004965001	190956	3/8"	166,0							1

8794 SB VDE Zyklop绝缘延长杆 · 短款 · 3/8"

- 短款

8794 SB VDE Zyklop绝缘延长杆 · 短款 · 3/8"



	EAN	□	⏏							
Code	4013288	□	⏏	mm						
05004964001	190949	3/8"	91,0							1

套筒条带 (织物带) B VDE · 10个位置

- 空的织物工具带, 可放置10个VDE扳手/批头套筒, 3/8"
- 带方便的弹簧扣
- 平滑的拧开解锁设计使得套筒的保存更安全, 使用更方便
- 可附着到墙壁、架子、工具车和维拉2go系列产品上



套筒条带 (织物带) B VDE · 10个位置



Code	EAN		
05003982001	4013288		1
	210913		
		Belt B VDE 0/10 1x 71,0x209,0	
		K30 1x 30,0x200,0	

6004 Joker VDE 4 组套 1 VDE 绝缘自调式扳手组套

根据IEC 60900在10,000 V电压下进行单独测试的工具, 以便在批准的电压1,000 V下安全工作。可调的VDE扳手可以连续自动夹紧指示尺寸范围内的所有六角形尺寸 (公制和英制)。

通过集成式杠杆机构牢固地将钳口之间的六角螺丝或螺栓夹紧, 从而显著降低了出现滑脱或损坏的风险。

棘轮功能可确保快速一致的旋拧操作, 且无需移开工具。

使用角宽直角棱形体, 可获得仅30°的反向旋转角度。采用单臂式设计, 结合棘轮功能和角宽棱形体, 即使在狭小空间内, 也能够进行操作。

由于具有2个部件的塑料绝缘, 可调焦的Joker 6004 VDE具有自然舒适的手柄。

手柄前端的防滑保护增加了安全性。滑动功能为非绝缘钳口提供了无触点安全开口, 从而提供了额外的保护。

- 内含 4 把可调节 Joker 6004 VDE的紧凑型帆布工具袋, 涵盖了 7 至 19mm 或 1/4" 至 3/4" 的所有公制和英制尺寸的应用

6004 Joker VDE VDE 绝缘自调式扳手

根据IEC 60900在10,000 V电压下进行单独测试的工具, 以便在批准的电压1,000 V下安全工作。可调的VDE扳手可以连续自动夹紧指示尺寸范围内的所有六角形尺寸 (公制和英制)。

通过集成式杠杆机构牢固地将钳口之间的六角螺丝或螺栓夹紧, 从而显著降低了出现滑脱或损坏的风险。

棘轮功能可确保快速一致的旋拧操作, 且无需移开工具。使用角宽直角棱形体, 可获得仅30°的反向旋转角度。

采用单臂式设计, 结合棘轮功能和角宽棱形体, 即使在狭小空间内, 也能够进行操作。由于具有2个部件的塑料绝缘, 可调焦的Joker 6004 VDE具有自然舒适的手柄。

手柄前端的防滑保护增加了安全性。滑动功能为非绝缘钳口提供了无触点安全开口, 从而提供了额外的保护。

- 可调 Joker 6004 VDE 涵盖相应应用领域的所有公制和英制尺寸
- 带有绝缘手柄的单独测试工具, 用于安全工作, 工作电压不超过 1,000 伏, 具有防滑保护功能, 可安全打开非绝缘钳口
- 自动无阻碍地夹紧六角螺栓和螺帽
- 避免在夹紧过程中产生打滑和损坏的杠杆机构
- 借助杠杆棘轮功能, 无需取下扳手便可快速流畅完成螺丝紧固工序
- 开口凹槽设计实现 30° 回转角

6004 Joker VDE 4 组套 1 VDE 绝缘自调式扳手组套

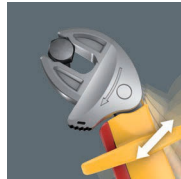

Code	EAN		
05020170001	221803		1
		6004 Joker VDE XS 1x 7-10 (1/4"-3/8")x119	
		6004 Joker VDE S 1x 10-13 (7/16"-1/2")x155	
		6004 Joker VDE M 1x 13-16 (1/2"-5/8")x190	
		6004 Joker VDE L 1x 16-19 (5/8"-3/4")x226	
		魔术贴 120 1x 50,0x120,0	

6004 Joker VDE XS VDE 绝缘自调式扳手

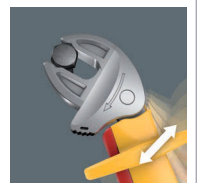

Code	EAN	mm	mm	mm		
05020150001	221797	7-10	1/4"-3/8"	119	7,7	3

6004 Joker VDE S VDE 绝缘自调式扳手

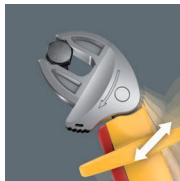

Code	EAN	mm	mm	mm		
05020151001	221766	10-13	7/16"-1/2"	155	10	3

6004 Joker VDE M VDE 绝缘自调式扳手

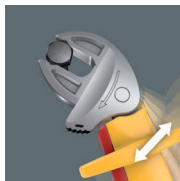

Code	EAN	mm	mm	mm		
05020152001	221780	13-16	1/2"-5/8"	190	12,4	3

6004 Joker VDE L VDE 绝缘自调式扳手

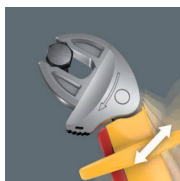

Code	EAN	mm	mm	mm		
05020153001	221773	16-19	5/8"-3/4"	226	14	3

400 i VDE 内六角绝缘螺丝刀

维拉VDE绝缘T型柄六角定扭螺丝刀适用于螺栓, 螺丝和螺帽。定扭装置配有防盗设计。

耐用的空转设计会发出清晰的响声和触觉反馈, 以避免过度施加扭力。

松开螺丝时可是加的扭力并无制限, 所以在拆卸螺丝时不必要追加使用其他工具。

- VDE绝缘, 每一件VDE绝缘T型柄定扭六角螺丝刀都经过测试, 保证在1, 000伏的环境下的安全使用。
- T型柄的设计适合传输紧固松开时施加的扭力
- 正确的紧固源于不失灵的定扭装置和准确的扭力传输
- 达到设定扭矩数值时可听到清晰的超负荷信号。
- 定扭装置的防盗设计避免意外地触动和激活造成扭力大小的更动



400 i VDE 内六角绝缘螺丝刀



Code	EAN	mm	Nm	mm	mm	mm	mm	
05004980001	206398	4,0	5,0	90	48	100	3 1/2"	1
05004981001	206114	5,0	5,0	90	48	100	3 1/2"	1





棘轮扳手

Zyklop Speed - 无法置信的快速和灵活



令人惊艳的紧凑收纳空间。独家开发的织布包使全新的棘轮套装更加坚固耐用。可直接摆放展示于工作间的搁板。织布包的材质能增加表层防护。更轻便更易于携带。“易寻”系统使用颜色区分尺寸。

- 42件棘轮组套，织布包
- 可自由转动的棘轮头，带5种预设的锁定位置
- 拥有维拉批头技术的所有优点
- 带固持功能的旋具套筒，适用于TORX®螺丝、适用于内六角螺丝、用于六角头螺栓、螺丝和螺母
- “易寻”色标系统：用特定的颜色代表不同端头种类和尺寸
- 可适配Wera 2go

8100 SA All-in Zyklop Speed 棘轮扳手组套 · 带固持功能， 1/4" 驱动 · 公制



Code	EAN		
05003755001	4013288 190994		1
		8000 A 1x 1/4"x152,0	
		8796 LA 1x 1/4"x150,0	
		8794 A 1x 1/4"x56,0	
		8790 HMA HF 1x 4,0x23,0; 1x 4,5x23,0; 1x 5,0x23,0; 1x 5,5x23,0; 1x 6,0x23,0; 1x 7,0x23,0; 1x 8,0x23,0; 1x 9,0x23,0; 1x 10,0x23,0; 1x 11,0x23,0; 1x 12,0x23,0; 1x 13,0x23,0; 1x 14,0x23,0	
		8767 A HF 1x TX 8x28,0; 1x TX 9x28,0; 1x TX 10x28,0; 1x TX 15x28,0; 1x TX 20x28,0; 1x TX 25x28,0; 1x TX 27x28,0; 1x TX 30x28,0; 1x TX 40x28,0	
		8740 A 1x 2,0x28,0; 1x 2,5x28,0	
		8740 A HF 1x 3,0x28,0; 1x 4,0x28,0; 1x 5,0x28,0; 1x 6,0x28,0; 1x 7,0x28,0; 1x 8,0x28,0	
		8751 A 1x PH 1x28,0; 1x PH 2x28,0; 1x PH 3x28,0	
		8755 A 1x PZ 1x28,0; 1x PZ 2x28,0; 1x PZ 3x28,0	
		8700 A FL 1x 0,8x5,5x28,0; 1x 1,2x6,5x28,0	
		螺帽取出器 1x 14,0x43,0	
		魔术贴 120 1x 50,0x120,0	

8100 SA 6 Zyklop Speed 棘轮扳手组套 · 1/4" 驱动 · 公制

- 可自由转动的棘轮头, 带5种预设的锁定位置
- 72细齿
- 小至5°的回转角
- 自由旋转护套, 可高效作业
- “易寻”色标系统: 用特定的颜色代表不同端头种类和尺寸
- 紧凑而极为坚固的织物盒包装, 体积小而轻便

8100 SA 6 Zyklop Speed 棘轮扳手组套 · 1/4" 驱动 · 公制



Code	EAN		
05004016001	174000		1
		□ 8000 A 1x 1/4"x152,0	
		● 8790 HMA 1x 5,0x23,0; 1x 5,5x23,0; 1x 6,0x23,0; 1x 7,0x23,0; 1x 8,0x23,0; 1x 10,0x23,0; 1x 11,0x23,0; 1x 12,0x23,0; 1x 13,0x23,0	
		■ 8794 LA 1x 1/4"x150,0	
		■ 8794 A 1x 1/4"x56,0	
		● 8784 A1 1x 1/4"x1/4"x37,0	
		+ 851/4 TZ PH 1x PH 1x50; 1x PH 2x50; 1x PH 3x50	
		+ 855/4 TZ PZ 1x PZ 1x50; 1x PZ 2x50	
		* 867/4 Z TORX® 1x TX 10x50; 1x TX 15x50; 1x TX 20x50; 1x TX 25x50; 1x TX 27x50; 1x TX 30x50	
		○ 840/4 Z Hex-Plus 1x 3,0x50; 1x 4,0x50; 1x 5,0x50; 1x 6,0x50	
		魔术贴 120 1x 50,0x120,0	

8100 SA 9 Zyklop Speed 棘轮扳手组套 · 1/4" 驱动 · 英制



Code	EAN		
05004019001	173843		1
		□ 8000 A 1x 1/4"x152,0	
		● 8790 HMA 1x 3/16"x23,0; 1x 7/32"x23,0; 1x 1/4"x23,0; 1x 3/32"x23,0; 1x 5/16"x23,0; 1x 11/32"x23,0; 1x 3/8"x23,0; 1x 7/16"x23,0; 1x 1/2"x23,0	
		■ 8794 LA 1x 1/4"x150,0	
		■ 8794 A 1x 1/4"x56,0	
		● 8784 A1 1x 1/4"x1/4"x37,0	
		+ 851/4 TZ PH 1x PH 1x50; 1x PH 2x50; 1x PH 3x50	
		+ 855/4 TZ PZ 1x PZ 1x50; 1x PZ 2x50	
		* 867/4 Z TORX® 1x TX 10x50; 1x TX 15x50; 1x TX 20x50; 1x TX 25x50; 1x TX 27x50; 1x TX 30x50	
		○ 840/4 Z Hex-Plus 1x 3/32"x50; 1x 3/16"x50; 1x 7/32"x50; 1x 1/4"x50	
		魔术贴 120 1x 50,0x120,0	

KK Zyklop MS1 Metal/Speed 组套 · 1/4" 驱动

- 极为快速的1/4" Zyklop Speed棘轮扳手, 可自由转动的棘轮头, 带5种预设的锁定位置
- 纤细型Zyklop Metal棘轮扳手, 超省力
- 小至5°的回转角
- 拨杆便于换向
- 坚固的织物盒包装

KK Zyklop MS1 Metal/Speed 组套 · 1/4" 驱动



Code	EAN		
05135949001	4013288 178633		1
		□ 8000 A 1x 1/4"x152,0	
		□ 8004 A 1x 1/4"x141,0	
		◐ 8796 LA 1x 1/4"x150,0	
		◐ 8794 LA 1x 1/4"x150,0	
		◐ 8794 SA 1x 1/4"x75,0	
		◐ 8784 A1 1x 1/4"x1/4"x37,0	
		◐ 8794 A 1x 1/4"x56,0	
		◐ 8795 A 1x 1/4"x35,5	

8100 SA 2 Zyklop Speed 棘轮扳手组套 · 1/4" 驱动 · 公制

- 42件套, 坚固的金属工具盒装

8100 SA 2 Zyklop Speed 棘轮扳手组套 · 1/4" 驱动 · 公制



Code	EAN		
05003533001	4013288 121103		1
		□ 8000 A 1x 1/4"x152,0	
		◐ 8790 HMA 1x 4,0x23,0; 1x 4,5x23,0; 1x 5,0x23,0; 1x 5,5x23,0; 1x 6,0x23,0; 1x 7,0x23,0; 1x 8,0x23,0; 1x 9,0x23,0; 1x 10,0x23,0; 1x 11,0x23,0; 1x 12,0x23,0; 1x 13,0x23,0; 1x 14,0x23,0	
		□ 8789 A 1x 1/4"x110,0	
		◐ 8794 A 1x 1/4"x56,0	
		◐ 8795 A 1x 1/4"x35,5	
		◐ 8784 A1 1x 1/4"x1/4"x37,0	
		◐ 8796 SA 1x 1/4"x75,0	
		◐ 8796 LA 1x 1/4"x150,0	
		⊕ 851/1 Z PH 1x PH 1x25; 1x PH 2x25; 1x PH 3x25	
		⊕ 855/1 Z PZ 1x PZ 1x25; 1x PZ 2x25; 1x PZ 3x25	
		⊕ 867/1 Z TORX® B0 1x TX 8x25; 1x TX 9x25; 1x TX 10x25; 1x TX 15x25; 1x TX 20x25; 1x TX 25x25; 1x TX 30x25; 1x TX 40x25	
		◐ 840/1 Z Hex-Plus 1x 3,0x25; 1x 4,0x25; 1x 5,0x25; 1x 6,0x25; 1x 8,0x25	
		◐ 800/1 Z 1x 0,6x4,5x25; 1x 1,0x5,5x25; 1x 1,2x8,0x25	

8100 SA 4 Zyklop Speed 棘轮扳手组套 · 1/4" 驱动 · 英制

- 41件套, 坚固的金属工具盒装

8100 SA 4 Zyklop Speed 棘轮扳手组套 · 1/4" 驱动 · 英制



Code	EAN		
05003535001	4013288 121127		1
		<ul style="list-style-type: none"> □ 8000 A 1x 1/4"x152,0 ● 8790 HMA 1x 3/16"x23,0; 1x 7/32"x23,0; 1x 1/4"x23,0; 1x 9/32"x23,0; 1x 5/16"x23,0; 1x 11/32"x23,0; 1x 3/8"x23,0; 1x 7/16"x23,0; 1x 1/2"x23,0; 1x 9/16"x23,0 □ 8789 A 1x 1/4"x110,0 □ 8794 A 1x 1/4"x56,0 □ 8795 A 1x 1/4"x35,5 ● 8784 A1 1x 1/4"x1/4"x37,0 □ 8796 SA 1x 1/4"x75,0 □ 8796 LA 1x 1/4"x150,0 + 851/1 Z PH 1x PH 1x25; 1x PH 2x25; 1x PH 3x25 + 855/1 Z PZ 1x PZ 1x25; 1x PZ 2x25; 1x PZ 3x25 ⊗ 867/1 Z TORX® BO 1x TX 8x25; 1x TX 9x25; 1x TX 10x25; 1x TX 15x25; 1x TX 20x25; 1x TX 25x25; 1x TX 30x25; 1x TX 40x25 ○ 840/1 Z Hex-Plus 1x 5/64"x25; 1x 3/32"x25; 1x 1/8"x25; 1x 9/64"x25; 1x 5/32"x25; 1x 3/16"x25; 1x 7/32"x25 ● 800/1 Z 1x 0,6x4,5x25; 1x 1,0x5,5x25; 1x 1,2x8,0x25 	

8100 SA/SC 2 Zyklop Speed 棘轮扳手组套 · 1/4" 驱动和 1/2" 驱动 · 公制

- 43件套, 坚固的金属工具盒装

8100 SA/SC 2 Zyklop Speed 棘轮扳手组套 · 1/4" 驱动和 1/2" 驱动 · 公制



Code	EAN		
05160785001	4013288 126610		1
		<ul style="list-style-type: none"> □ 8000 A 1x 1/4"x152,0 ● 8790 HMA 1x 4,0x23,0; 1x 4,5x23,0; 1x 5,0x23,0; 1x 5,5x23,0; 1x 6,0x23,0; 1x 7,0x23,0; 1x 8,0x23,0; 1x 9,0x23,0; 1x 10,0x23,0; 1x 12,0x23,0; 1x 13,0x23,0 ● 8784 A1 1x 1/4"x1/4"x37,0 □ 8796 LA 1x 1/4"x150,0 □ 8000 C 1x 1/2"x277,0 ● 8790 HMC 1x 13,0x37,0; 1x 14,0x37,0; 1x 15,0x37,0; 1x 16,0x37,0; 1x 17,0x37,0; 1x 18,0x37,0; 1x 19,0x37,0; 1x 21,0x37,0; 1x 22,0x37,0; 1x 24,0x37,0 □ 8796 LC 1x 1/2"x250,0 ● 816 R 1x 1/4"x119 ● 800/4 Z 1x 1,0x5,5x89 ○ 840/4 Z Hex-Plus 1x 3,0x89; 1x 4,0x89; 1x 5,0x89; 1x 6,0x89 + 851/4 Z PH 1x PH 1x89; 1x PH 2x89; 1x PH 3x89 + 855/4 Z PZ 1x PZ 1x89; 1x PZ 2x89; 1x PZ 3x89 ⊗ 867/4 Z TORX® BO 1x TX 10x89; 1x TX 15x89; 1x TX 20x89; 1x TX 25x89; 1x TX 30x89 	

KK Zyklop Speed 组套

- 帆布包可系在腰带上

KK Zyklop Speed 组套



Code	EAN		
05051045001	155313		1
	4013288		
		8000 A 1x 1/4"x152,0	
		8784 A1 1x 1/4"x1/4"x37,0	
		8794 LA 1x 1/4"x150,0	
		851/4 TZ PH 1x PH 1x50; 1x PH 2x50; 1x PH 3x50	
		855/4 TZ PZ 1x PZ 1x50; 1x PZ 2x50	
		867/4 Z TORX® 1x TX 10x50; 1x TX 15x50; 1x TX 20x50; 1x TX 25x50; 1x TX 27x50; 1x TX 30x50	
		800/4 Z 1x 1,0x5,5x50	
		840/4 Z Hex-Plus 1x 3,0x50; 1x 4,0x50; 1x 5,0x50; 1x 6,0x50	
		8790 HMA 1x 5,5x23,0; 1x 6,0x23,0; 1x 7,0x23,0; 1x 8,0x23,0; 1x 10,0x23,0; 1x 12,0x23,0; 1x 13,0x23,0	
		魔术贴 70 1x 50,0x70,0	

8000 A Zyklop Speed 棘轮扳手 · 1/4" 驱动

- 集物种不同的棘轮功能于一身
- 飞轮的设计和易于抓握的自由旋转护套提高了工作效率
- 可自由转动的棘轮头, 按钮释放, 可拨杆左右换向
- 细齿结构得到小至5°的回转角
- 也可用作螺丝刀

8000 A Zyklop Speed 棘轮扳手 · 1/4" 驱动



Code	EAN						
05003500001	121868	1/4"	152,0				1

8000 A Zyklop Speed 棘轮扳手吊卡装 · 1/4" 驱动



Code	EAN						
05073260001	128034		8000 A 1x 1/4"x152,0				3

Zyklop Metal推杆式棘轮扳手



织布包装更加便于携带,更节省空间,这意味着存放同样工具的组套拥有更小更舒适的包装。

新包装寻找工具更加方便,同时比以往任何一种包装形式都更加轻巧便携。这种包装的保护性能使得里面的工具在织布包掉落时不会因相互碰撞而带来伤害。

- 棘轮扳手极为纤细、省力
- 小至4.7°的回转角
- 非拆卸式的推杆头可平滑转换
- “易寻”色标系统

8100 SA 7 Zyklop Metal 推杆换向棘轮扳手套组 · 1/4" 驱动 · 公制



Code	EAN			
05004017001	4013288 173898			1
		□	8003 A 1x 1/4"x141,0	
		●	8790 HMA 1x 5,0x23,0; 1x 5,5x23,0; 1x 6,0x23,0; 1x 7,0x23,0; 1x 8,0x23,0; 1x 10,0x23,0; 1x 11,0x23,0; 1x 12,0x23,0; 1x 13,0x23,0	
		◻◻	8794 LA 1x 1/4"x150,0	
		◻◻	8794 A 1x 1/4"x56,0	
		●◻	8784 A1 1x 1/4"x1/4"x37,0	
		+	851/1 Z PH 1x PH 1x25; 1x PH 2x25; 1x PH 3x25	
		+	855/1 Z PZ 1x PZ 1x25; 1x PZ 2x25	
		✦	867/1 TORX® 1x TX 10x25; 1x TX 15x25; 1x TX 20x25; 1x TX 25x25; 1x TX 27x25; 1x TX 30x25	
		○	840/1 Z Hex-Plus 1x 3,0x25; 1x 4,0x25; 1x 5,0x25; 1x 6,0x25	

8100 SA 10 Zyklop Metal 推杆换向棘轮扳手套组 · 1/4" 驱动 · 英制



Code	EAN			
05004020001	4013288 173904			1
		□	8003 A 1x 1/4"x141,0	
		●	8790 HMA 1x 3/16"x23,0; 1x 7/32"x23,0; 1x 1/4"x23,0; 1x 9/32"x23,0; 1x 5/16"x23,0; 1x 11/32"x23,0; 1x 3/8"x23,0; 1x 7/16"x23,0; 1x 1/2"x23,0	
		◻◻	8794 LA 1x 1/4"x150,0	
		◻◻	8794 A 1x 1/4"x56,0	
		●◻	8784 A1 1x 1/4"x1/4"x37,0	
		+	851/1 Z PH 1x PH 1x25; 1x PH 2x25; 1x PH 3x25	
		+	855/1 Z PZ 1x PZ 1x25; 1x PZ 2x25	
		✦	867/1 TORX® 1x TX 10x25; 1x TX 15x25; 1x TX 20x25; 1x TX 25x25; 1x TX 27x25; 1x TX 30x25	
		○	840/1 Z Hex-Plus 1x 5/32"x25; 1x 3/16"x25; 1x 7/32"x25; 1x 1/4"x25	

8003 A Zyklop Metal 推杆换向棘轮扳手 · 1/4" 驱动

- 用于1/4"内四方，带球锁
- 带换向拨杆，扁长设计。较长杠杆。极其坚固，无需担心扭矩过载。通体铬钼钢锻造
- Zyklop Metal 推杆式：双齿结构使其坚固的38齿也能得到和76细齿一样的4.7°回转角
- 非拆卸式的推杆头可平滑转换

8003 A Zyklop Metal 推杆换向棘轮扳手 · 1/4" 驱动



Code	EAN	1/4"	mm	mm	mm		
05004003001	174017	1/4"	141,0	21	22		3

Zyklop Metal 拨杆式棘轮扳手



织布包装更加便于携带，更节省空间，这意味着存放同样工具的组套拥有更小更舒适的包装。新包装寻找工具更加方便，同时比以往任何一种包装形式都更加轻巧便携。这种包装的保护性能使得里面的工具在织布包掉落时不会因相互碰撞而带来伤害。

- 棘轮扳手极为纤细、省力
- 小至4.7°的回转角
- 非拆卸式的推杆头可平滑转换
- “易寻”色标系统
- 拨杆便于换向
- 棘轮扳手极为纤细、省力
- 小至5°的回转角

8100 SA 8 Zyklop Metal 拨杆换向棘轮扳手套组 · 1/4" 驱动 · 公制



Code	EAN		
05004018001	173836		1
		<ul style="list-style-type: none"> 8004 A 1x 1/4"x141,0 8790 HMA 1x 5,0x23,0; 1x 5,5x23,0; 1x 6,0x23,0; 1x 7,0x23,0; 1x 8,0x23,0; 1x 10,0x23,0; 1x 11,0x23,0; 1x 12,0x23,0; 1x 13,0x23,0 8794 LA 1x 1/4"x150,0 8794 A 1x 1/4"x56,0 8784 A1 1x 1/4"x1/4"x37,0 851/1 Z PH 1x PH 1x25; 1x PH 2x25; 1x PH 3x25 855/1 Z PZ 1x PZ 1x25; 1x PZ 2x25 867/1 TORX® 1x TX 10x25; 1x TX 15x25; 1x TX 20x25; 1x TX 25x25; 1x TX 27x25; 1x TX 30x25 840/1 Z Hex-Plus 1x 3,0x25; 1x 4,0x25; 1x 5,0x25; 1x 6,0x25 魔术贴 120 1x 50,0x120,0 	

8100 SA 11 Zyklop Metal 拨杆换向棘轮扳手组套 · 1/4" 驱动 · 英制



Code	EAN			
05004021001	173850			1
		8004 A	1x 1/4"x141,0	
		8790 HMA	1x 3/16"x23,0; 1x 7/32"x23,0; 1x 1/4"x23,0; 1x 9/32"x23,0; 1x 5/16"x23,0; 1x 11/32"x23,0; 1x 3/8"x23,0; 1x 7/16"x23,0; 1x 1/2"x23,0	
		8794 LA	1x 1/4"x150,0	
		8794 A	1x 1/4"x56,0	
		8784 A1	1x 1/4"x1/4"x37,0	
		851/1 Z PH	1x PH 1x25; 1x PH 2x25; 1x PH 3x25	
		855/1 Z PZ	1x PZ 1x25; 1x PZ 2x25	
		867/1 TORX®	1x TX 10x25; 1x TX 15x25; 1x TX 20x25; 1x TX 25x25; 1x TX 27x25; 1x TX 30x25	
		840/1 Z Hex-Plus	1x 3/32"x25; 1x 3/16"x25; 1x 7/32"x25; 1x 1/4"x25	

8100 SA 12 HF Zyklop Metal 拨杆换向棘轮扳手组套 · 1/4" 驱动 · 公制

- 操作螺丝、螺栓和螺母时带固持功能

8100 SA 12 HF Zyklop Metal 拨杆换向棘轮扳手组套 · 1/4" 驱动 · 公制



Code	EAN			
05003756001	190987			1
		8004 A	1x 1/4"x141	
		8794 LA	1x 1/4"x150,0	
		8794 A	1x 1/4"x56,0	
		8790 HMA HF	1x 5,0x23,0; 1x 5,5x23,0; 1x 6,0x23,0; 1x 7,0x23,0; 1x 8,0x23,0; 1x 10,0x23,0; 1x 11,0x23,0; 1x 12,0x23,0; 1x 13,0x23,0	
		螺帽取出器	1x 14,0x43,0	
		魔术贴 120	1x 50,0x120,0	

8004 A Zyklop Metal 拨杆换向棘轮扳手 · 1/4" 驱动

- 拨杆便于换向
- 棘轮扳手极为纤细、省力
- 小至5°的回转角
- 套筒锁定装置

8004 A Zyklop Metal 拨杆换向棘轮扳手 · 1/4" 驱动



Code	EAN						
05004004001	174024	1/4"	141,0	19	22		3

8790 HMA Zyklop 1/4" 套筒

- 1/4" Zyklop套筒
- 用于手动和非冲击电动工具
- 尾部滚花以便于手指握持操作
- 带球锁
- “易寻”色标系统: 用特定的颜色代表不同端头种类和尺寸

8790 HMA Zyklop 1/4" 套筒



Code	EAN		mm	mm	mm	mm	
05003501001	120083		4,0	23,0	6,9	13,0	1
05003502001	120106		4,5	23,0	7,5	13,0	1
05003503001	120113		5,0	23,0	8,2	13,0	1
05003504001	120120		5,5	23,0	8,8	13,0	1
05003505001	120137		6,0	23,0	9,4	13,0	1
05003506001	120144		7,0	23,0	11,0	13,0	1
05003507001	120151		8,0	23,0	12,0	13,0	1
05003508001	120090		9,0	23,0	13,0	14,0	1
05003509001	120168		10,0	23,0	14,5	14,5	1
05003510001	120175		11,0	23,0	16,0	15,0	1
05003511001	120182		12,0	23,0	17,0	16,0	1
05003512001	120199		13,0	23,0	18,0	17,0	1
05003513001	120205		14,0	23,0	20,0	18,0	1
05003499001	206862		15,0	23,0	21,5	19,0	1
05003514001	120212		3/16"	23,0	7,5	13,0	1
05003515001	120229		7/32"	23,0	8,8	13,0	1
05003516001	120236		1/4"	23,0	11,0	13,0	1
05003517001	120243		9/32"	23,0	11,0	13,0	1
05003518001	120250		5/16"	23,0	12,0	13,0	1
05003519001	120267		11/32"	23,0	13,0	14,0	1
05003520001	120274		3/8"	23,0	14,5	14,5	1
05003521001	120281		7/16"	23,0	16,0	15,0	1
05003522001	120298		1/2"	23,0	18,0	17,0	1
05003523001	120304		9/16"	23,0	20,0	18,0	1

8790 HMA HF Zyklop 1/4" 套筒 · 带固持功能

- (非冲击) 套筒, 用于机动和电动工具
- 固持功能确保螺丝牢固黏着在工具上
- “易寻”色标系统: 用特定的颜色代表不同端头种类和尺寸
- 高品质铬钢制, 亚光镀铬
- 带球锁, 尾部滚花以便于手指握持

8790 HMA HF Zyklop 1/4" 套筒 · 带固持功能



Code	EAN		mm	mm	mm	mm	
05003717001	185631		4,0	23,0	7,0	11,0	1
05003718001	185648		4,5	23,0	7,8	11,0	1
05003719001	185655		5,0	23,0	8,9	11,0	1
05003720001	185662		5,5	23,0	9,2	11,0	1
05003721001	185679		6,0	23,0	10,5	11,0	1
05003722001	185686		7,0	23,0	11,9	11,0	1
05003723001	185693		8,0	23,0	12,9	11,0	1
05003724001	185709		9,0	23,0	14,1	12,0	1
05003725001	185716		10,0	23,0	15,6	12,5	1
05003726001	185723		11,0	23,0	17,4	13,0	1
05003727001	185730		12,0	23,0	18,4	14,0	1
05003728001	185747		13,0	23,0	19,5	15,0	1
05003729001	185754		14,0	23,0	20,8	16,0	1
05003010001	206855		15,0	23,0	21,5	18,5	1

套筒条带 A 1 Zyklop 套筒组套 · 带固持功能 · 1/4" 驱动

采用维拉的典型设计, 牢固的织物条带内装有9个旋具套筒, 非常节省空间。平滑的拧开解锁设计使得套筒的保存更安全, 使用更方便。

带“易寻”色标系统, 可轻松快速地根据尺寸找到所需套筒。带弹簧扣, 可以牢固地扣在皮带环或口袋上。带固持功能, 操作方便, 并可防止作业中在接近工件时丢失螺丝。

可通过反面的魔术贴将条带附着到墙壁、架子、工具车和维拉2go系列产品上。

- 牢固的织物条带, 内含9个1/4"驱动的旋具套筒
- 操作螺丝、螺栓和螺母时带固持功能
- 平滑的拧开解锁设计使得套筒的保存更安全, 使用更方便
- “易寻”色标系统: 用特定的颜色代表不同端头种类和尺寸
- 可附着到墙壁、架子、工具车和维拉2go系列产品上

套筒条带 A 1 Zyklop 套筒组套 · 带固持功能 · 1/4" 驱动



Code	EAN		
05003880001	4013288 190758		1
		● 8790 HMA HF 1x 4,0x23,0; 1x 4,5x23,0; 1x 5,0x23,0; 1x 5,5x23,0; 1x 6,0x23,0; 1x 7,0x23,0; 1x 8,0x23,0; 1x 10,0x23,0; 1x 13,0x23,0	
		螺帽取出器 1x 14,0x43,0	
		Belt A 0/9 1x 39,0x238,0	
		魔术贴 30 1x 30,0x200,0	

螺帽取出器

- 用于从带固持功能的套筒中简单地取出螺母
- 用于从带固持功能的套筒中简单地取出螺母(1/4", 3/8", 1/2")
- 六角防滚动保护, 防止螺丝刀的滚动

螺帽取出器



	EAN								
Code	4013288	mm	mm						
05050005001	192554	14,0	43,0						1

织布条带 A 4 Zyklop 套筒组套 · 1/4" 驱动

- 牢固的织物条带, 内含9个1/4"驱动的套筒
- 用于手动和非冲击电动工具
- 平滑的拧开解锁设计使得套筒的保存更安全, 使用更方便
- “易寻”色标系统: 用特定的颜色代表不同端头种类和尺寸
- 可附着到墙壁、架子、工具车和维拉2go系列产品上

织布条带 A 4 Zyklop 套筒组套 · 1/4" 驱动



Code	EAN		
05003883001	4013288 190789		1
		● 8790 HMA 1x 5,0x23,0; 1x 5,5x23,0; 1x 6,0x23,0; 1x 7,0x23,0; 1x 8,0x23,0; 1x 10,0x23,0; 1x 11,0x23,0; 1x 12,0x23,0; 1x 13,0x23,0	
		Belt A 0/9 1x 39,0x238,0	
		魔术贴 30 1x 30,0x200,0	

套筒磁性条带 A 4 Zyklop 套筒组套 · 1/4" 驱动
套筒条带, 含9件手动和机器操作的套筒 (非冲击), 1/4".
拧转解锁设计, 用于安全收纳并轻松取放套筒。

含“易寻”色标系统用特定颜色代表不同刀头花形和尺寸, 有助于轻松快速查找所需工具。

条带可暂时吸附到金属表面, 含拧转解锁设计, 确保安全固定收纳套筒套筒。

- 9 件套筒组件含套筒条带, 1/4"
- 条带含便于取用的套筒旋转扣支座, 用于暂时安装到墙壁、柜子、车间用滚轮小车
- 平滑的拧开解锁设计使得套筒的保存更安全, 使用更方便
- 带“易寻”色标系统, 可轻松找到所需套筒

套筒磁性条带 A 4 Zyklop 套筒组套 · 1/4" 驱动



Code	EAN		
05005400001	223197		1
		● 8790 HMA 1x 5,0x23,0; 1x 5,5x23,0; 1x 6,0x23,0; 1x 7,0x23,0; 1x 8,0x23,0; 1x 10,0x23,0; 1x 11,0x23,0; 1x 12,0x23,0; 1x 13,0x23,0	
		9600 1x 30,0x270,0	

织布条带 A Imperial 1 Zyklop 增强型内六角旋具套筒组套 · 带固持功能 · 1/4" 驱动 · 英式



Code	EAN		
05003884001	194992		1
		○ 8740 A 1x 5/64"x28,0; 1x 3/32"x28,0; 1x 7/64"x28,0	
		○ 8740 A HF 1x 1/8"x28,0; 1x 9/64"x28,0; 1x 5/32"x28,0; 1x 3/16"x28,0; 1x 7/32"x28,0; 1x 1/4"x28,0	
		Belt A 0/9 1x 39,0x238,0	
		魔术贴 30 1x 30,0x200,0	

套筒磁性条带 A Imperial 1 Zyklop 套筒组套 · 1/4" 驱动 · 英制

套筒条带, 含9件手动和机器操作的套筒 (非冲击), 1/4".
拧转解锁设计, 用于安全收纳并轻松取放套筒。

含“易寻”色标系统用特定颜色代表不同刀头花形和尺寸, 有助于轻松快速查找所需工具。

条带可暂时吸附到金属表面, 含拧转解锁设计, 确保安全固定收纳套筒套筒。

- 9 件套筒组件含套筒条带, 1/4"
- 条带含便于取用的套筒旋转扣支座, 用于暂时安装到墙壁、柜子、车间用滚轮小车
- 平滑的拧开解锁设计使得套筒的保存更安全, 使用更方便
- 带“易寻”色标系统, 可轻松找到所需套筒

套筒磁性条带 A Imperial 1 Zyklop 套筒组套 · 1/4" 驱动 · 英制



Code	EAN		
05005420001	223227		1
		● 8790 HMA 1x 3/16"x23,0; 1x 7/32"x23,0; 1x 1/4"x23,0; 1x 9/32"x23,0; 1x 5/16"x23,0; 1x 11/32"x23,0; 1x 3/8"x23,0; 1x 7/16"x23,0; 1x 1/2"x23,0	
		9600 1x 30,0x270,0	

8790 HMA Deep 1/4" 加长型套筒

加长型 1/4" 手动和机械用套筒 (ISO 2725 第3部分) 内藏卡位球锁; 用于外六角螺栓和套筒。用于手动和机器操作 (非敲击型), 可应用于低位紧固和凸头螺纹杆。带“易寻”色标系统, 可轻松找到所需套筒。即便是手上有油, 也能轻松握持。

与双六角形批头相比, 此六角形批头允许强大的传输力量及减少螺栓边缘或螺丝头的形变。

尽管在有限空间内, 由于它的小后回转角度, 细齿棘轮让双六角形变得多余。

- 长型扳手用于低位旋紧, 甚至可以应用在狭小空间的凸头螺纹杆上。
- 采用六角型面, 可实现高力矩传输的精确螺栓紧固操作, 同时对螺丝帽凹槽部分提供了更良好的保护
- “易寻”色标系统: 用特定的颜色代表不同端头种类和尺寸
- 尾部滚花以便于手指握持操作
- 用于手动和机器运行 (非冲击型), 球型档环
- 采用亚光镀铬的铬钒合金材质

8790 HMA Deep 1/4" 加长型套筒



Code	EAN		mm	mm	mm	mm	
05004500001	210258		4,0	50,0	6,7	11,8	1
05004501001	210128		5,0	50,0	8,0	11,8	1
05004502001	210241		5,5	50,0	8,6	11,8	1
05004503001	210265		6,0	50,0	9,2	11,8	1
05004504001	210272		7,0	50,0	10,8	11,8	1
05004505001	210289		8,0	50,0	11,8	11,0	1
05004506001	210296		9,0	50,0	12,8	12,0	1
05004507001	210302		10,0	50,0	14,7	12,8	1
05004508001	210319		11,0	50,0	15,8	14,0	1
05004509001	210326		12,0	50,0	16,8	15,0	1
05004510001	210333		13,0	50,0	17,8	16,0	1
05004511001	210340		14,0	50,0	19,8	17,0	1
05004512001	210357		15,0	50,0	20,8	18,0	1

织布条带 A Deep 1 套筒组套 · 1/4" 驱动

牢固耐用的织物带, 采用典型的Wera设计, 具有9长型1/4英寸手动和机器套筒插件 (非抗冲击型) 可用于狭小空间。更为顺滑的旋转机构, 可确保稳固的握持效果, 同时方便取下套筒。随附用于连接到束带圈或工具包的抓钩。

采用纤维网底面以及弯钩和环扣带, 安装方便, 例如可安装在墙壁、置物架、工具小车或Wera 2go工具运输系统。Wera出品的长型1/4英寸、3/8英寸、1/2英寸手动和机器套筒扳手插口 (ISO 2725 第3部分), 适用于手动和机器操作 (非敲击型), 也可采用低位旋拧和凸头螺纹杆。

通过简单易用的工具寻找器, 采用基于尺寸的颜色编码-可快速方便地找到所需工具。即便是手上有油, 也能轻松握紧。具有六角型面和球头固定槽。与双六角形批头相比, 此六角形批头允许强大的传输力量及减少螺栓边缘或螺丝头的形变。

尽管在有限空间内, 由于它的小后回转角度, 细齿棘轮让双六角形变得多余。用于外六角螺栓和套筒。

- 牢固的织物条带, 内含9个1/4"驱动的套筒
- 平滑的拧开解锁设计使得套筒的保存更安全, 使用更方便
- 加长型 1/4" 手动和机械 (非抗冲击型) 套筒, 用于紧凑结构空间内的低挡位的螺纹配合连接, 以及凸头螺纹杆
- 采用六角型面, 可更有效的实现高力矩传输的精确紧固操作, 同时可保护工具表面。
- “易寻”色标系统: 用特定的颜色代表不同端头种类和尺寸

织布条带 A Deep 1 套筒组套 · 1/4" 驱动



Code	EAN		
05004525001	210371		1
		8790 HMA Deep 1x 5,0x50,0; 1x 5,5x50,0; 1x 6,0x50,0; 1x 7,0x50,0; 1x 8,0x50,0; 1x 10,0x50,0; 1x 11,0x50,0; 1x 12,0x50,0; 1x 13,0x50,0	
		Belt A 0/9 1x 39,0x238,0	
		魔术贴 30 1x 30,0x200,0	

套筒磁性条带 A Deep 1 套筒组套 · 1/4" 驱动
套筒条带, 含 9 件手动和机器操作的长型套筒 (非冲击), 1/4"。拧转解锁设计, 用于安全收纳并轻松取放套筒。

维拉长型 1/4" 手动和机器操作的套筒 (ISO 2725 第 3 部分) 允许手动和 (非冲击) 机械用, 用于难以触及的连接件和伸出的螺纹杆。

含“易寻”色标系统用特定颜色代表不同刀头花形和尺寸, 有助于轻松快速查找所需工具。采用防滑设计, 即使手上有油也可轻松持握。

带六角端头和球锁。

六角端头可实现高力度传递, 螺栓或螺丝边缘的负荷比双六角花形小。由于细齿棘轮的反向旋转角度较小, 可在密闭空间内作业, 因此也不需要双六角花形。

用于外六角螺栓和螺丝。条带可暂时吸附到金属表面, 含拧转解锁设计, 确保安全固定收纳套筒套筒。

- 9 件套筒组件含套筒条带, 1/4"
- 条带含便于取用的套筒旋转扣支座, 用于暂时安装到墙壁、柜子、车间用滚轮小车
- 平滑的拧开解锁设计使得套筒的保存更安全, 使用更方便
- 加长型 1/4" 手动和机械 (非抗冲击型) 套筒, 用于紧凑结构空间内的低挡位的螺纹配合连接, 以及凸头螺纹杆
- 采用六角型面, 可传输高力矩并更精确旋紧操作, 同时可保护花形

套筒磁性条带 A Deep 1 套筒组套 · 1/4" 驱动



Code	EAN		
05005410001	223210		1
		8790 HMA Deep 1x 5,0x50,0; 1x 5,5x50,0; 1x 6,0x50,0; 1x 7,0x50,0; 1x 8,0x50,0; 1x 10,0x50,0; 1x 11,0x50,0; 1x 12,0x50,0; 1x 13,0x50,0	
		9600 1x 30,0x270,0	

8767 A TORX® Zyklop 旋具 套筒 · 1/4" 驱动



Code	EAN							
Code	EAN		mm	mm	mm	mm	mm	
05003390001	219602		TX 10	28,0	12,0	12,5	11,0	1
05003391001	219619		TX 20	28,0	12,0	12,5	11,0	1
05003392001	219626		TX 25	28,0	12,0	12,5	11,0	1
05003393001	219633		TX 30	28,0	12,0	12,5	11,0	1

8767 A HF TORX® Zyklop 旋具 套筒 · 1/4" 驱动 · 带固持功能

- 旋具套筒 (非冲击), 用于手动和机动工具
- 固持功能确保螺丝牢固黏着在工具上
- “易寻”色标系统: 用特定的颜色代表不同端头种类和尺寸
- 尾部滚花以便于手指握持操作
- 高品质铬钒钢, 亚光镀铬

8767 A HF TORX® Zyklop 旋具 套筒 · 1/4" 驱动 · 带固持功能



Code	EAN							
Code	EAN		mm	mm	mm	mm	mm	
05003360001	186829		TX 8	28,0	12,0	12,5	11,0	1
05003361001	186843		TX 9	28,0	12,0	12,5	11,0	1
05003362001	186836		TX 10	28,0	12,0	12,5	11,0	1
05003363001	186850		TX 15	28,0	12,0	12,5	11,0	1
05003364001	186867		TX 20	28,0	12,0	12,5	11,0	1
05003365001	186874		TX 25	28,0	12,0	12,5	11,0	1
05003366001	186881		TX 25	100,0	12,0	12,5	83,0	1
05003367001	186898		TX 27	28,0	12,0	12,5	11,0	1
05003368001	186904		TX 27	100,0	12,0	12,5	83,0	1
05003369001	186911		TX 30	28,0	12,0	12,5	11,0	1
05003370001	186928		TX 30	100,0	12,0	12,5	83,0	1
05003371001	186935		TX 40	28,0	12,0	12,5	11,0	1
05003372001	186942		TX 40	100,0	12,0	12,5	83,0	1

套筒条带 A 3 TORX® HF Zyklop 旋具套筒组套 · 带固持功能 · 1/4" 驱动

采用维拉的典型设计, 牢固的织物条带内装有9个套筒, 非常节省空间。平滑的拧开解锁设计使得套筒的保存更安全, 使用更方便。带“易寻”色标系统, 可轻松快速地根据尺寸找到所需套筒。带弹簧扣, 可以牢固地扣在皮带环或口袋上。

坚固的超短型旋具套筒, 拥有维拉批头技术的所有优点。带固持功能, 操作方便, 并可防止作业中在接近工件时丢失螺丝。

可通过反面的魔术贴将条带附着到墙壁、架子、工具车和维拉2go系列产品上。

- 牢固的织物条带, 内含9个1/4"驱动的旋具套筒
- 拥有维拉批头技术的所有优点
- 操作螺丝、螺栓时带固持功能
- 平滑的拧开解锁设计使得套筒的保存更安全, 使用更方便
- 可附着到墙壁、架子、工具车和维拉2go系列产品上
- “易寻”色标系统: 用特定的颜色代表不同端头种类和尺寸

套筒条带 A 3 TORX® HF Zyklop 旋具套筒组套 · 带固持功能 · 1/4" 驱动



Code	EAN			
05003882001	190772			1
			8767 A HF 1x TX 8x28,0; 1x TX 9x28,0; 1x TX 10x28,0; 1x TX 15x28,0; 1x 3,7x3,7xTX 20x28,0; 1x 4,1x4,1xTX 25x28,0; 1x 4,8x4,8xTX 27x28,0; 1x 5,4x5,4xTX 30x28,0; 1x 6,5x6,5xTX 40x28,0	
			Belt A 0/9 1x 39,0x238,0	
			魔术贴 30 1x 30,0x200,0	

8767 A TORX® HF 1 Zyklop 旋具套筒组套 · 带固持功能 · 1/4" 驱动

- 紧凑而极为坚固的织物盒包装, 体积小而轻便
- 旋具套筒 (非冲击), 用于手动和电动工具
- 固持功能确保螺丝牢固黏着在工具上
- “易寻”色标系统: 用特定的颜色代表不同端头种类和尺寸
- 套筒尾部滚花以便于手指握持操作
- 加长型设计

8767 A TORX® HF 1 Zyklop 旋具套筒组套 · 带固持功能 · 1/4" 驱动



Code	EAN			
05003375001	191014			1
			8767 A HF 1x TX 25x100,0; 1x TX 27x100,0; 1x TX 30x100,0; 1x TX 40x100,0	
			魔术贴 70 1x 50,0x70,0	

8740 A HF Zyklop 套筒 · 1/4" 驱动 · 带固持功能

- 旋具套筒 (非冲击), 用于手动和机动工具
- 固持功能确保螺丝牢固黏着在工具上
- Hex-Plus六角增强型可延长螺丝头的寿命

8740 A HF Zyklop 套筒 · 1/4" 驱动 · 带固持功能



Code	EAN	Hex	Hex	Length	Width	Height	Weight
Code	EAN	mm	mm	mm	mm	mm	g
05003332001	187123	3,0		28,0	12,0	12,5	1
05003333001	187178	4,0		28,0	12,0	12,5	1
05003334001	187185	4,0		100,0	12,0	12,5	1
05003335001	187192	5,0		28,0	12,0	12,5	1
05003336001	187208	5,0		100,0	12,0	12,5	1
05003337001	187215	6,0		28,0	12,0	12,5	1
05003338001	187222	6,0		100,0	12,0	12,5	1
05003341001	189547	7,0		28,0	12,0	12,5	1
05003342001	189554	7,0		100,0	12,0	12,5	1
05003339001	187239	8,0		28,0	12,0	12,5	1
05003340001	187246	8,0		100,0	12,0	12,5	1
05003383001	189868		1/8"	28,0	12,0	12,5	1
05003384001	189875		9/64"	28,0	12,0	12,5	1
05003385001	189882		5/32"	28,0	12,0	12,5	1
05003386001	189899		3/16"	28,0	12,0	12,5	1
05003387001	189905		7/32"	28,0	12,0	12,5	1
05003388001	189912		1/4"	28,0	12,0	12,5	1
05003389001	189844		5/16"	28,0	12,0	12,5	1

8740 A Zyklop 套筒 · 1/4" 驱动

- 旋具套筒 (非冲击), 用于手动和机动工具
- Hex-Plus六角增强型可延长螺丝头的寿命

8740 A Zyklop 套筒 · 1/4" 驱动



Code	EAN	Hex	Hex	Length	Width	Height	Weight
Code	EAN	mm	mm	mm	mm	mm	g
05003330001	187154	2,0		28,0	12,0	12,5	1
05003331001	187161	2,5		28,0	12,0	12,5	1
05003380001	189820		5/64"	28,0	12,0	12,5	1
05003381001	189837		3/32"	28,0	12,0	12,5	1
05003382001	189851		7/64"	28,0	12,0	12,5	1

套筒条带 A 2 Zyklop 增强型内六角旋具套筒组套 · 带固持功能 · 1/4" 驱动

采用维拉的典型设计, 牢固的织物条带内装有8个内六角旋具套筒, 非常节省空间。

平滑的拧开解锁设计使得套筒的保存更安全, 使用更方便。

带“易寻”色标系统, 可轻松快速地根据尺寸找到所需套筒。带弹簧扣, 可以牢固地扣在皮带环或口袋上。

可通过反面的魔术贴将条带附着到墙壁、架子、工具车和维拉2go系列产品上。

- 牢固的织物条带, 内含8个1/4"驱动的旋具套筒
- 拥有维拉批头技术的所有优点
- 带固持功能的旋具套筒, 适用于内六角螺丝
- “易寻”色标系统: 用特定的颜色代表不同端头种类和尺寸
- 平滑的拧开解锁设计使得套筒的保存更安全, 使用更方便
- 可附着到墙壁、架子、工具车和维拉2go系列产品上

套筒条带 A 2 Zyklop 增强型内六角旋具套筒组套 · 带固持功能 · 1/4" 驱动



Code	EAN	Content	Weight
05003381001	190765	8740 A 1x 2,0x28,0; 1x 2,5x28,0 8740 A HF 1x 3,0x28,0; 1x 4,0x28,0; 1x 5,0x28,0; 1x 6,0x28,0; 1x 7,0x28,0; 1x 8,0x28,0 Belt A 0/8 1x 39,0x220,0 魔术贴 30 1x 30,0x200,0	1

8740 A HF 1 Zyklop 旋具套筒组套 · 带固持功能 · 1/4" 驱动

- 紧凑而极为坚固的织物盒包装, 体积小而轻便
- 旋具套筒 (非冲击), 用于手动和电动工具
- 固持功能确保螺丝牢固黏着在工具上
- “易寻”色标系统: 用特定的颜色代表不同端头种类和尺寸
- 套筒尾部滚花以便于手指握持操作
- 加长型设计

8740 A HF 1 Zyklop 旋具套筒组套 · 带固持功能 · 1/4" 驱动

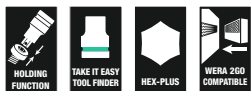

Code	EAN		
05003345001	191007		1
		8740 A HF 1x 4,0x100,0; 1x 5,0x100,0; 1x 6,0x100,0; 1x 7,0x100,0; 1x 8,0x100,0 魔术贴 70 1x 50,0x70,0	

8751 A Phillips Zyklop 旋具套筒 · 1/4" 驱动

- 短小设计

8751 A Phillips Zyklop 旋具套筒 · 1/4" 驱动



Code	EAN						
05003350001	187253	PH 1	28,0	12,0	11,0	12,5	1
05003351001	187260	PH 2	28,0	12,0	11,0	12,5	1
05003352001	187277	PH 3	28,0	12,0	11,0	12,5	1

8755 A Pozidriv 旋具套筒 · 1/4" 驱动

- 短小设计

8755 A Pozidriv 旋具套筒 · 1/4" 驱动

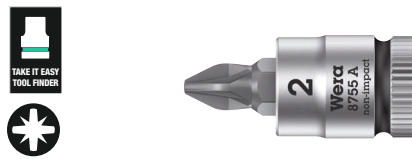

Code	EAN						
05003353001	187284	PZ 1	28,0	12,0	11,0	12,5	1
05003354001	187291	PZ 2	28,0	12,0	11,0	12,5	1
05003355001	187307	PZ 3	28,0	12,0	11,0	12,5	1

8700 A FL 用于一字螺丝 Zyklop 旋具套筒 · 1/4" 驱动

- 短小设计

8700 A FL 用于一字螺丝 Zyklop 旋具套筒 · 1/4" 驱动

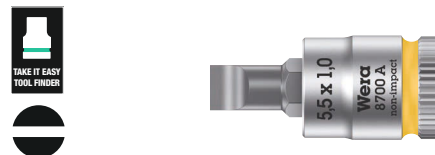

Code	EAN						
05003320001	187314	0,8	5,5	28,0	12,0	11,0	11,0
05003321001	187321	1,0	5,5	28,0	12,0	11,0	11,0
05003322001	187338	1,2	6,5	28,0	12,0	11,0	11,0

8796 LA Zyklop 活锁延长杆 · 带自由旋转护套 · 长型 · 1/4" 驱动

- 用于1/4"内四方, 带球锁
- 快速锁定装置即可锁定、也可快速更换套筒
- 带自由旋转护套, 可快速紧固和松开螺丝螺母

8796 LA Zyklop 活锁延长杆 · 带自由旋转护套 · 长型 · 1/4" 驱动



Code	EAN						
05003531001	121059	1/4"	150,0				1

8796 SA Zyklop活锁延长杆，带自由旋转护套，短型，1/4"

- 用于1/4"内四方，带球锁
- 快速锁定装置即可锁定、也可快速更换套筒
- 带自由旋转护套，可快速紧固和松开螺丝螺母

8796 SA Zyklop活锁延长杆，带自由旋转护套，短型，1/4"



Code	EAN	□	⌀						
05003530001	121042	1/4"	75,0						1

8794 LA Zyklop 延长杆，带自由旋转护套，长型，1/4"

带自由旋转护套，可快速紧固和松开螺丝螺母。

8794 LA Zyklop 延长杆，带自由旋转护套，长型，1/4"



Code	EAN	□	⌀						
05003526001	121073	1/4"	150,0						1

8794 SA Zyklop 延长杆，带自由旋转护套，短型，1/4"

带自由旋转护套，可快速紧固和松开螺丝螺母。

8794 SA Zyklop 延长杆，带自由旋转护套，短型，1/4"



Code	EAN	□	⌀						
05003525001	121066	1/4"	75,0						1

8789 A Zyklop T型滑动手柄，1/4"

1/4" Zyklop T型滑动手柄，带滑柄驱动。用于1/4"内四方，带球锁。用于高扭矩传递。

8789 A Zyklop T型滑动手柄，1/4"



Code	EAN	□	⌀						
05003524001	121493	1/4"	110,0						3

8795 A Zyklop 万向接头，1/4"

1/4" Zyklop万向接头。用于1/4"内四方，带球锁。

8795 A Zyklop 万向接头，1/4"



Code	EAN	□	⌀						
05003528001	121509	1/4"	35,5						1

8784 A1 Zyklop 批头用转接头 · 1/4"

- 1/4" Zyklop转接头, 带快速接头, 可快速更换批头

8784 A1 Zyklop 批头用转接头 · 1/4"



Code	EAN				mm				
05003529001	121035	1/4"	1/4"	37,0					1

8794 A Zyklop 摆动延长杆 · 1/4"

Zyklop摆动式延长杆可以在15°的范围内活动, 使得工具可在隐蔽或封闭的安装区域内快速而精确地工作。

8794 A Zyklop 摆动延长杆 · 1/4"



Code	EAN			mm					
05003527001	121080	1/4"	56,0						1

套筒条带 (织物带) A · 9个位置



Code	EAN								
05003891001	192424								1
								Belt A 0/9 1x 39,0x238,0	
								魔术贴 30 1x 30,0x200,0	

套筒条带 (织物带) A · 8个位置



Code	EAN								
05003890001	192417							1	
								Belt A 0/8 1x 39,0x220,0	
								魔术贴 30 1x 30,0x200,0	

9600 磁性套筒条带 · 1/4" · 空

1 套筒条带, 空。用于至多 10 件套筒和/或批头套筒, 1/4" 驱动。条带可暂时吸附到金属表面, 含拧转解锁设计, 确保安全固定收纳套筒套筒。

- 条带含便于取用的套筒旋转扣支座, 用于暂时安装到墙壁、柜子、车间用滚轮小车
- 平滑的拧开解锁设计使得套筒的保存更安全, 使用更方便
- 空, 用于至多 10 件套筒, 1/4"

9600 磁性套筒条带 · 1/4" · 空

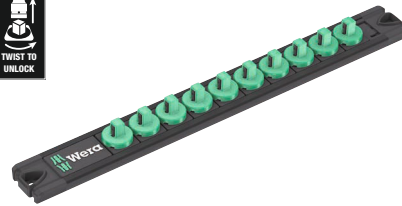

Code	EAN			mm	mm				
05136420001	223326	30,0	270,0						1

Zyklop Speed - 无法置信的快速和灵活



织布包装更加便于携带, 更节省空间, 这意味着存放同样工具的组套拥有更小更舒适的包装。新包装寻找工具更加方便, 同时比以往任何一种包装形式都更加轻巧便携。这种包装的保护性能使得里面的工具在织布包掉落时不会因相互碰撞而带来伤害。

- 可自由转动的棘轮头, 带5种预设的锁定位置
- 72细齿
- 小至5°的回转角
- 自由旋转护套, 可高效作业
- “易寻”色标系统: 用特定的颜色代表不同端头种类和尺寸
- 紧凑而极为坚固的织物盒包装, 体积小而轻便

8100 SB 多合一 Zyklop Speed 棘轮组套 · 3/8"驱动

- 采用扭动解锁系统, 方便拆卸棘轮

8100 SB 多合一 Zyklop Speed 棘轮组套 · 3/8"驱动



Code	EAN		
05003536001	4013288 225573		1
		8000 B 1x 3/8"x199,0	
		8794 B 1x 3/8"x76,0	
		8796 LB 1x 3/8"x200,0	
		8790 HMB HF 1x 6,0x29,0; 1x 7,0x29,0; 1x 8,0x29,0; 1x 9,0x29,0; 1x 10,0x29,0; 1x 11,0x29,0; 1x 12,0x29,0; 1x 13,0x29,0; 1x 14,0x29,0; 1x 15,0x29,0; 1x 16,0x29,0; 1x 17,0x29,0; 1x 18,0x29,0; 1x 19,0x29,0	
		8767 B HF 1x TX 10x35,0; 1x TX 15x35,0; 1x TX 20x35,0; 1x TX 25x35,0; 1x TX 27x35,0; 1x TX 30x35,0; 1x TX 40x35,0; 1x TX 45x38,5; 1x TX 50x38,5	
		8740 B HF 1x 3,0x35,0; 1x 4,0x35,0; 1x 5,0x35,0; 1x 6,0x35,0; 1x 7,0x38,5; 1x 8,0x38,5; 1x 9,0x38,5; 1x 10,0x38,5	
		螺帽取出器 1x 14,0x43,0	
		魔术贴 240 1x 50,0x240,0	

8100 SB 6 Zyklop Speed 棘轮扳手组套 · 3/8" 驱动 · 公制



Code	EAN		
05004046001	4013288 173911		1
		<input type="checkbox"/> 8000 B 1x 3/8"x199,0	
		<input checked="" type="checkbox"/> 8790 HMB 1x 8,0x29,0; 1x 10,0x29,0; 1x 12,0x29,0; 1x 13,0x29,0; 1x 15,0x29,0; 1x 16,0x30,0; 1x 17,0x30,0; 1x 18,0x30,0; 1x 19,0x30,0	
		<input checked="" type="checkbox"/> <input type="checkbox"/> 8794 LB 1x 3/8"x200,0	
		<input checked="" type="checkbox"/> <input type="checkbox"/> 8794 B 1x 3/8"x76,0	
		<input checked="" type="checkbox"/> <input type="checkbox"/> 8784 B1 1x 1/4"x3/8"x44,0	
		<input checked="" type="checkbox"/> 851/4 TZ PH 1x PH 1x50; 1x PH 2x50; 1x PH 3x50	
		<input checked="" type="checkbox"/> 855/4 TZ PZ 1x PZ 1x50; 1x PZ 2x50; 1x PZ 3x50	
		<input checked="" type="checkbox"/> 867/4 Z TORX® 1x TX 20x50; 1x TX 25x50; 1x TX 27x50; 1x TX 30x50; 1x TX 40x50	
		<input type="checkbox"/> 840/4 Z Hex-Plus 1x 4,0x50; 1x 5,0x50; 1x 6,0x50; 1x 8,0x50	
		<input type="checkbox"/> 800/4 Z 1x 1,0x5,5x50	

8100 SB 9 Zyklop Speed 棘轮扳手组套 · 3/8" 驱动 · 英制



Code	EAN		
05004049001	4013288 173980		1
		<input type="checkbox"/> 8000 B 1x 3/8"x199,0	
		<input checked="" type="checkbox"/> 8790 HMB 1x 1/4"x29,0; 1x 5/16"x29,0; 1x 3/8"x29,0; 1x 7/16"x29,0; 1x 1/2"x29,0; 1x 9/16"x29,0; 1x 5/8"x30,0; 1x 11/16"x30,0; 1x 3/4"x30,0	
		<input checked="" type="checkbox"/> <input type="checkbox"/> 8794 LB 1x 3/8"x200,0	
		<input checked="" type="checkbox"/> <input type="checkbox"/> 8794 B 1x 3/8"x76,0	
		<input checked="" type="checkbox"/> <input type="checkbox"/> 8784 B1 1x 1/4"x3/8"x44,0	
		<input checked="" type="checkbox"/> 851/4 TZ PH 1x PH 1x50; 1x PH 2x50; 1x PH 3x50	
		<input checked="" type="checkbox"/> 855/4 TZ PZ 1x PZ 1x50; 1x PZ 2x50; 1x PZ 3x50	
		<input checked="" type="checkbox"/> 867/4 Z TORX® 1x TX 20x50; 1x TX 25x50; 1x TX 27x50; 1x TX 30x50; 1x TX 40x50	
		<input type="checkbox"/> 840/4 Z Hex-Plus 1x 3/16"x50; 1x 7/32"x50; 1x 1/4"x50; 1x 5/16"x50	
		<input type="checkbox"/> 800/4 Z 1x 1,0x5,5x50	

8100 SB 2 Zyklop Speed 棘轮扳手组套 · 3/8" 驱动 · 公制

• 43件套, 坚固的金属工具箱装

8100 SB 2 Zyklop Speed 棘轮扳手组套 · 3/8" 驱动 · 公制



Code	EAN		
05003594001	4013288 121141		1
		<input type="checkbox"/> 8000 B 1x 3/8"x199,0	
		<input checked="" type="checkbox"/> 8790 HMB 1x 6,0x29,0; 1x 7,0x29,0; 1x 8,0x29,0; 1x 9,0x29,0; 1x 10,0x29,0; 1x 11,0x29,0; 1x 12,0x29,0; 1x 13,0x29,0; 1x 14,0x29,0; 1x 15,0x29,0; 1x 16,0x30,0; 1x 17,0x30,0; 1x 18,0x30,0; 1x 19,0x30,0; 1x 20,0x30,0; 1x 21,0x30,0; 1x 22,0x30,0; 1x 24,0x32,0	
		<input type="checkbox"/> 8789 B 1x 3/8"x165,0	
		<input checked="" type="checkbox"/> 8794 B 1x 3/8"x76,0	
		<input checked="" type="checkbox"/> 8795 B 1x 3/8"x50,0	
		<input checked="" type="checkbox"/> 8784 B1 1x 1/4"x3/8"x44,0	
		<input checked="" type="checkbox"/> 8796 SB 1x 3/8"x125,0	
		<input checked="" type="checkbox"/> 8796 LB 1x 3/8"x200,0	
		<input checked="" type="checkbox"/> 851/1 Z PH 1x PH 2x25; 1x PH 3x25	
		<input checked="" type="checkbox"/> 855/1 Z PZ 1x PZ 2x25; 1x PZ 3x25	
		<input checked="" type="checkbox"/> 867/1 Z TORX® BO 1x TX 10x25; 1x TX 15x25; 1x TX 20x25; 1x TX 25x25; 1x TX 27x25; 1x TX 30x25; 1x TX 40x25	
		<input type="checkbox"/> 840/1 Z Hex-Plus 1x 3,0x25; 1x 4,0x25; 1x 5,0x25; 1x 6,0x25; 1x 8,0x25; 1x 10,0x25	
		<input checked="" type="checkbox"/> 800/1 Z 1x 1,0x5,5x25	

8100 SB 4 Zyklop Speed 棘轮扳手组套 · 3/8" 驱动 · 英制

• 38件套, 坚固的金属工具箱装

8100 SB 4 Zyklop Speed 棘轮扳手组套 · 3/8" 驱动 · 英制



Code	EAN		
05003596001	4013288 121165		1
		<input type="checkbox"/> 8000 B 1x 3/8"x199,0	
		<input checked="" type="checkbox"/> 8790 HMB 1x 1/4"x29,0; 1x 5/16"x29,0; 1x 11/32"x29,0; 1x 3/8"x29,0; 1x 7/16"x29,0; 1x 1/2"x29,0; 1x 9/16"x29,0; 1x 5/8"x30,0; 1x 11/16"x30,0; 1x 3/4"x30,0; 1x 13/16"x30,0; 1x 7/8"x30,0	
		<input type="checkbox"/> 8789 B 1x 3/8"x165,0	
		<input checked="" type="checkbox"/> 8794 B 1x 3/8"x76,0	
		<input checked="" type="checkbox"/> 8795 B 1x 3/8"x50,0	
		<input checked="" type="checkbox"/> 8784 B1 1x 1/4"x3/8"x44,0	
		<input checked="" type="checkbox"/> 8796 SB 1x 3/8"x125,0	
		<input checked="" type="checkbox"/> 8796 LB 1x 3/8"x200,0	
		<input checked="" type="checkbox"/> 851/1 Z PH 1x PH 2x25; 1x PH 3x25	
		<input checked="" type="checkbox"/> 855/1 Z PZ 1x PZ 2x25; 1x PZ 3x25	
		<input checked="" type="checkbox"/> 867/1 Z TORX® BO 1x TX 10x25; 1x TX 15x25; 1x TX 20x25; 1x TX 25x25; 1x TX 27x25; 1x TX 30x25; 1x TX 40x25	
		<input checked="" type="checkbox"/> 800/1 Z 1x 1,0x5,5x25	
		<input type="checkbox"/> 840/1 Z Hex-Plus 1x 5/64"x25; 1x 3/32"x25; 1x 1/8"x25; 1x 9/64"x25; 1x 5/32"x25; 1x 3/16"x25; 1x 7/32"x25	

Zyklop Speed - 无法置信的快速和灵活



27 件 $\frac{3}{8}$ " 驱动棘轮组套用于常规自行车作业，具有有各类配件：1 个 Zyklop Speed 棘轮，配 $\frac{3}{8}$ " 驱动，10 个 Zyklop 套筒，2 个 Zyklop 批头套筒，含 30mm 极细刀头，更适合狭窄工作空间。

易寻色系系统：用特定颜色代表不同尺寸。

1 个 Zyklop 延长杆（短），快速旋转护套，1 个 Wobble 延长杆，1 个批头适配器，1 个连接部件， $\frac{3}{8}$ " 外四角至 $\frac{1}{2}$ " 外四角，10 个坚固而具有韧性的通用批头。

令人难以置信的紧凑组套安排，许多工具在紧凑空间内，得益于高度坚固耐用的帆布工具袋。

可直立放置，清晰安排在车间货架。

帆布材料提供额外表面保护。重量轻，体积小，便于携带。

- 27 件 $\frac{3}{8}$ " 棘轮，含细齿 Zyklop Speed 棘轮，配可旋转棘轮头、一键释放和右/左切换
- 回转角仅 5° ，利于狭窄空间。
- 套管和批头适合最常见的螺丝应用场景，如公路自行车、山地自行车和电动自行车
- 各类工具置于轻便耐用的帆布袋中，便于运输
- 配接杆和 $\frac{3}{8}$ " 内四角套筒和 $\frac{1}{2}$ " 外四角套筒，用于安装特殊自行车工具

自行车组套 7



Code	EAN		
05004175001	4013288 220608		1
		8000 B 1x $\frac{3}{8}$ "x199,0	
		8790 HMB 1x 6,0x29,0; 1x 7,0x29,0; 1x 8,0x29,0; 1x 9,0x29,0; 1x 10,0x29,0; 1x 11,0x29,0; 1x 12,0x29,0; 1x 13,0x29,0; 1x 14,0x29,0	
		8790 HMB Deep 1x 15,0x64,0	
		8740 B 1x 8,0x100,0; 1x 10,0x100,0	
		8794 B 1x $\frac{3}{8}$ "x76,0	
		8784 B1 1x $\frac{1}{4}$ "x $\frac{3}{8}$ "x44,0	
		8794 SB 1x $\frac{3}{8}$ "x125,0	
		781 B 1x 781 B/C, $\frac{1}{2}$ "x36,0x $\frac{3}{8}$ "	
		840/4 Z Hex-Plus 1x 3,0x50; 1x 4,0x50; 1x 5,0x50; 1x 6,0x50	
		867/4 Z TORX® 1x TX 10x50; 1x TX 15x50; 1x TX 20x50; 1x TX 25x50; 1x TX 27x50; 1x TX 30x50	

8000 B Zyklop Speed 棘轮扳手 · $\frac{3}{8}$ " 驱动

- 集物种不同的棘轮功能于一身
- 飞轮的设计和易于抓握的自由旋转护套提高了工作效率
- 可自由转动的棘轮头，按钮释放，可拨杆左右换向
- 细齿结构得到小至 5° 的回转角
- 也可用作螺丝刀

8000 B Zyklop Speed 棘轮扳手 · $\frac{3}{8}$ " 驱动



Code	EAN					
05003550001	4013288 121875	$\frac{3}{8}$ "	199,0			1

8000 B Zyklop Speed 棘轮扳手吊卡装 · 3/8" 驱动



Code		EAN		
05073261001		4013288	128041	3
		8000 B	1x 3/8"x199.0	

8100 SB 12 Zyklop 舒适棘轮组套 · 转向杆 · 3/8" 驱动 · 公制

16 件 Zyklop 舒适型棘轮组套, 装在一个轻便、坚固、耐用的织物盒中。Zyklop 舒适棘轮的双组件塑料套管即使在寒冷的环境中也能舒适地工作, 同时保护表面免受损坏。

Zyklop Impaktor 套筒即使在极端条件下的使用寿命依旧高于平均水平。

通过“Take it easy”工具查找装置(按尺寸进行颜色编码), 可以轻松获得所需的尺寸。Zyklop 加长件还可以轻松操作难以触及的螺丝和螺栓。

8100 SB 12 Zyklop 舒适棘轮组套 · 转向杆 · 3/8" 驱动 · 公制



Code		EAN		
05005530001		4013288	227980	1
		8010 B	1x 3/8"x230,0	
		8790 B Impaktor	1x 8,0x30,0; 1x 10,0x30,0; 1x 11,0x30,0; 1x 12,0x30,0; 1x 13,0x30,0; 1x 14,0x30,0; 1x 15,0x30,0; 1x 16,0x30,0; 1x 17,0x30,0; 1x 18,0x30,0; 1x 19,0x30,0; 1x 21,0x32,0; 1x 22,0x32,0; 1x 24,0x32,0	
		8798 B	1x 3/8"x152,4	

8100 SB 13 Zyklop 舒适棘轮组套 · 转向杆 · 3/8" 驱动 · 英制

- 11 件 Zyklop 舒适型棘轮组套; 英制尺寸

8100 SB 13 Zyklop 舒适棘轮组套 · 转向杆 · 3/8" 驱动 · 英制



Code	EAN				
05005531001	227973				1
		<input type="checkbox"/>	8010 B 1x 3/8"x230,0		
		<input checked="" type="checkbox"/>	8790 B Impaktor 1x 1/4"x30,0; 1x 5/16"x30,0; 1x 3/8"x30,0; 1x 7/16"x30,0; 1x 1/2"x30,0; 1x 9/16"x30,0; 1x 5/8"x30,0; 1x 11/16"x30,0; 1x 3/4"x30,0		
		<input checked="" type="checkbox"/>	8798 B 1x 3/8"x152,4		

8010 B Zyklop 舒适棘轮 · 带转向杆 · 3/8" 驱动

引人注目的 Wera 风格 Zyklop 舒适棘轮与转向杆。舒适的双组件式塑料套管。保护敏感表面。体积小，甚至可在有限空间内作业。

80 齿细齿机构，仅 4.5° 较小回转角。带转向杆，轻松反转。通过按钮锁定安全套筒。

8010 B Zyklop 舒适棘轮 · 带转向杆 · 3/8" 驱动



Code	EAN							
05005540001	227195	3/8"	230,0					1

Zyklop Metal推杆式棘轮扳手



织布包装更加便于携带,更节省空间,这意味着存放同样工具的组套拥有更小更舒适的包装。

新包装寻找工具更加方便,同时比以往任何一种包装形式都更加轻巧便携。这种包装的保护性能使得里面的工具在织布包掉落时不会因相互碰撞而带来伤害。

- 棘轮扳手极为纤细、省力
- 小至4.7°的回转角
- 非拆卸式的推杆头可平滑转换

8100 SB 7 Zyklop Metal 推杆换向棘轮扳手套组 · 3/8" 驱动 · 公制



Code	EAN		
05004047001	4013288 173867		1
		8003 B 1x 3/8"x222,0	
		8790 HMB 1x 8,0x29,0; 1x 10,0x29,0; 1x 12,0x29,0; 1x 13,0x29,0; 1x 15,0x29,0; 1x 16,0x30,0; 1x 17,0x30,0; 1x 18,0x30,0; 1x 19,0x30,0	
		8794 LB 1x 3/8"x200,0	
		8794 B 1x 3/8"x76,0	
		8784 B1 1x 1/4"x3/8"x44,0	
		851/1 Z PH 1x PH 1x25; 1x PH 2x25; 1x PH 3x25	
		855/1 Z PZ 1x PZ 1x25; 1x PZ 2x25	
		867/1 TORX® 1x TX 15x25; 1x TX 20x25; 1x TX 25x25; 1x TX 27x25; 1x TX 30x25; 1x TX 40x25	
		840/1 Z Hex-Plus 1x 3,0x25; 1x 4,0x25; 1x 5,0x25; 1x 6,0x25; 1x 8,0x25	

8100 SB 10 Zyklop Metal 推杆换向棘轮扳手组套 · 3/8" 驱动 · 英制



Code	EAN			
05004050001	4013288 173935			1
		8003 B 1x 3/8"x222,0		
		8790 HMB 1x 1/4"x29,0; 1x 5/16"x29,0; 1x 3/8"x29,0; 1x 7/16"x29,0; 1x 1/2"x29,0; 1x 9/16"x29,0; 1x 5/8"x30,0; 1x 11/16"x30,0; 1x 3/4"x30,0		
		8794 LB 1x 3/8"x200,0		
		8794 B 1x 3/8"x76,0		
		8784 B1 1x 1/4"x3/8"x44,0		
		851/1 Z PH 1x PH 1x25; 1x PH 2x25; 1x PH 3x25		
		855/1 Z PZ 1x PZ 1x25; 1x PZ 2x25		
		867/1 TORX® 1x TX 15x25; 1x TX 20x25; 1x TX 25x25; 1x TX 27x25; 1x TX 30x25; 1x TX 40x25		
		840/1 Z Hex-Plus 1x 5/32"x25; 1x 3/16"x25; 1x 7/32"x25; 1x 1/4"x25; 1x 5/16"x25		

8003 B Zyklop Metal 推杆换向棘轮扳手 · 3/8" 驱动

- 带换向拨杆, 扁长设计。较长杠杆。
- 极其坚固, 无需担心扭矩过载。通体铬钼钢锻造。
- Zyklop Metal 推杆式: 双齿结构使其坚固的38齿也能得到和76细齿一样的4.7°回转角。
- 非拆卸式的推杆头可平滑转换
- 用于3/8"内四方, 带球锁

8003 B Zyklop Metal 推杆换向棘轮扳手 · 3/8" 驱动



Code	EAN							
05004033001	4013288 174031	3/8"	222,0	27	29			3

Zyklop Metal 拨杆式棘轮扳手



织布包装更加便于携带, 更节省空间, 这意味着存放同样工具的组套拥有更小更舒适的包装。

新包装寻找工具更加方便, 同时比以往任何一种包装形式都更加轻巧便携。

这种包装的保护性能使得里面的工具在织布包掉落时不会因相互碰撞而带来伤害。

- 拨杆便于换向
- 棘轮扳手极为纤细、省力
- 小至5°的回转角
- 紧凑而极为坚固的织物盒包装, 体积小而轻便

8100 SB 8 Zyklop Metal 拨杆换向棘轮扳手套组 · 3/8" 驱动 · 公制



Code	EAN		
	4013288		
05004048001	173928		1
		8004 B 1x 3/8"x222,0	
		8790 HMB 1x 8,0x29,0; 1x 10,0x29,0; 1x 12,0x29,0; 1x 13,0x29,0; 1x 15,0x29,0; 1x 16,0x30,0; 1x 17,0x30,0; 1x 18,0x30,0; 1x 19,0x30,0	
		8794 LB 1x 3/8"x200,0	
		8794 B 1x 3/8"x76,0	
		8784 B1 1x 1/4"x3/8"x44,0	
		851/1 Z PH 1x PH 1x25; 1x PH 2x25; 1x PH 3x25	
		855/1 Z PZ 1x PZ 1x25; 1x PZ 2x25	
		867/1 TORX® 1x TX 15x25; 1x TX 20x25; 1x TX 25x25; 1x TX 27x25; 1x TX 30x25; 1x TX 40x25	
		840/1 Z Hex-Plus 1x 3,0x25; 1x 4,0x25; 1x 5,0x25; 1x 6,0x25; 1x 8,0x25	

8100 SB 11 Zyklop Metal 拨杆换向棘轮扳手组套 · 3/8" 驱动 · 英制



Code	EAN			
05004051001	173959			1
		□	8004 B 1x 3/8"x222,0	
		●	8790 HMB 1x 1/4"x29,0; 1x 5/16"x29,0; 1x 3/8"x29,0; 1x 7/16"x29,0; 1x 1/2"x29,0; 1x 9/16"x29,0; 1x 5/8"x30,0; 1x 11/16"x30,0; 1x 3/4"x30,0	
		□	8794 LB 1x 3/8"x200,0	
		□	8794 B 1x 3/8"x76,0	
		●	8784 B1 1x 1/4"x3/8"x44,0	
		+	851/1 Z PH 1x PH 1x25; 1x PH 2x25; 1x PH 3x25	
		+	855/1 Z PZ 1x PZ 1x25; 1x PZ 2x25	
		+	867/1 TORX® 1x TX 15x25; 1x TX 20x25; 1x TX 25x25; 1x TX 27x25; 1x TX 30x25; 1x TX 40x25	
		○	840/1 Z Hex-Plus 1x 5/32"x25; 1x 3/16"x25; 1x 7/32"x25; 1x 1/4"x25; 1x 5/16"x25	

8100 SB HF 1 Zyklop Metal 拨杆换向棘轮扳手组套 · 带固持功能, 3/8" 驱动 · 公制

- 套筒带颜色标识不同尺寸

8100 SB HF 1 Zyklop Metal 拨杆换向棘轮扳手组套 · 带固持功能, 3/8" 驱动 · 公制



Code	EAN			
05003785001	195081			1
		□	8004 B 1x 3/8"x222,0	
		●	8790 HMB HF 1x 8,0x29,0; 1x 10,0x29,0; 1x 12,0x29,0; 1x 13,0x29,0; 1x 15,0x29,0; 1x 16,0x29,0; 1x 17,0x29,0; 1x 18,0x29,0; 1x 19,0x29,0	
		□	8794 LB 1x 3/8"x200,0	
		□	8794 B 1x 3/8"x76,0	
			螺帽取出器 1x 14,0x43,0	
			魔术贴 240 1x 50,0x240,0	

Zyklop Metal 拨杆换向棘轮扳手, 3/8"

- 拨杆便于换向
- 棘轮扳手极为纤细、省力
- 小至5°的回转角
- 套筒锁定装置

8004 B Zyklop Metal 拨杆换向棘轮扳手 · 3/8" 驱动



Code	EAN	□	⌘	U	⊕		
05004034001	174048	3/8"	222,0	26	29		3

8790 B Impaktor 套筒扳手嵌件 · 3/8" 驱动。

- 适合采用电动或气动扳手的应用, 3/8" 驱动
- Impaktor技术, 使用寿命高于平均水平
- 采用六角型面, 可传输高力矩并更精确旋紧操作, 同时可保护花形
- 带“易寻”色标系统, 可轻松找到所需套筒
- 带十字孔和环状扣环, 可固定套筒的固定销和O环

8790 B Impaktor 套筒扳手嵌件 · 3/8" 驱动。



Code	EAN	mm	mm	mm	mm	mm	mm	mm
05005500001	227218	8,0	30,0	14,1	19,0	1		
05005501001	227225	10,0	30,0	16,6	19,0	1		
05005502001	227232	11,0	30,0	17,8	19,0	1		
05005503001	227249	12,0	30,0	18,2	19,0	1		
05005504001	227256	13,0	30,0	20,0	22,0	1		
05005505001	227263	14,0	30,0	21,0	22,0	1		
05005506001	227270	15,0	30,0	22,0	22,0	1		
05005507001	227287	16,0	30,0	22,0	24,0	1		
05005508001	227294	17,0	30,0	23,0	25,0	1		
05005509001	227300	18,0	30,0	23,0	26,0	1		
05005510001	227317	19,0	30,0	25,0	27,8	1		
05005511001	227324	21,0	32,0	27,0	30,0	1		
05005512001	227331	22,0	32,0	28,0	32,0	1		
05005513001	227348	24,0	32,0	30,0	34,0	1		
05005514001	227362	1/4"	30,0	11,0	19,0	1		
05005515001	227379	5/16"	30,0	14,1	19,0	1		
05005516001	227386	3/8"	30,0	16,6	19,0	1		
05005517001	227393	7/16"	30,0	17,8	19,0	1		
05005518001	227416	1/2"	30,0	20,0	22,0	1		
05005519001	227423	9/16"	30,0	21,0	22,0	1		
05005520001	227430	5/8"	30,0	22,0	24,0	1		
05005521001	227447	11/16"	30,0	23,0	25,0	1		
05005522001	227454	3/4"	30,0	25,0	28,0	1		
05005523001	227461	13/16"	32,0	27,0	30,0	1		
05005524001	227478	7/8"	32,0	28,0	32,0	1		
05005525001	227485	15/16"	32,0	30,0	34,0	1		
05005526001	227492	1"	32,0	32,0	36,0	1		

8790 HMB Zyklop 3/8" 套筒

- 3/8" Zyklop套筒
- 用于手动和非冲击电动工具
- 尾部滚花以便于手指握持操作
- “易寻”色标系统: 用特定的颜色代表不同端头种类和尺寸

8790 HMB Zyklop 3/8" 套筒



Code	EAN	mm	mm	mm	mm	mm	mm
05003551001	120311	6,0	29,0	10,5	18,0	1	
05003552001	120328	7,0	29,0	11,0	18,0	1	
05003553001	120335	8,0	29,0	12,2	18,0	1	
05003554001	120342	9,0	29,0	13,5	18,0	1	
05003555001	120359	10,0	29,0	14,5	18,0	1	
05003556001	120366	11,0	29,0	16,0	18,0	1	
05003557001	120373	12,0	29,0	17,0	18,0	1	
05003558001	120380	13,0	29,0	18,5	20,0	1	
05003559001	120397	14,0	29,0	19,5	22,0	1	
05003560001	120403	15,0	29,0	21,0	24,0	1	
05003561001	120410	16,0	30,0	22,0	24,0	1	
05003562001	120427	17,0	30,0	23,5	24,0	1	
05003563001	120434	18,0	30,0	24,5	24,0	1	
05003564001	120441	19,0	30,0	26,0	24,0	1	
05003565001	120458	20,0	30,0	28,0	25,0	1	
05003566001	120465	21,0	30,0	28,0	25,0	1	
05003567001	120472	22,0	30,0	32,0	25,0	1	
05003568001	120489	24,0	32,0	32,0	25,0	1	
05003569001	120496	1/4"	29,0	11,0	18,0	1	
05003570001	120502	5/16"	29,0	12,2	18,0	1	
05003571001	120519	11/32"	29,0	13,5	18,0	1	
05003572001	120526	3/8"	29,0	14,5	18,0	1	
05003573001	120533	7/16"	29,0	16,0	18,0	1	
05003574001	120649	1/2"	29,0	18,5	20,0	1	
05003575001	120557	9/16"	29,0	19,5	22,0	1	
05003576001	120564	5/8"	30,0	22,0	24,0	1	
05003577001	120571	11/16"	30,0	23,0	24,0	1	
05003578001	120588	3/4"	30,0	26,0	24,0	1	
05003579001	120595	13/16"	30,0	28,0	25,0	1	
05003580001	120601	7/8"	30,0	32,0	25,0	1	

8790 HMB HF Zyklus 3/8" 套筒 · 带固持功能

- (非冲击) 套筒, 用于机动和电动工具
- 固持功能确保螺丝牢固黏着在工具上
- “易寻”色标系统: 用特定的颜色代表不同端头种类和尺寸
- 高品质铬钒钢, 亚光镀铬
- 带球锁, 尾部滚花以便于手指握持

8790 HMB HF Zyklus 3/8" 套筒 · 带固持功能



Code	EAN	mm	mm	mm	mm	mm	mm	mm	mm	mm
05003740001	193919	6,0	29,0	12,7	17,5	6,5	1			
05003741001	193926	7,0	29,0	13,2	17,5	6,5	1			
05003742001	193933	8,0	29,0	14,2	17,5	6,5	1			
05003743001	193940	9,0	29,0	15,7	17,5	6,5	1			
05003744001	193957	10,0	29,0	17,0	17,5	8,0	1			
05003745001	193964	11,0	29,0	18,2	17,5	9,5	1			
05003746001	193971	12,0	29,0	19,0	17,5	9,5	1			
05003747001	193988	13,0	29,0	20,4	19,5	9,5	1			
05003748001	193995	14,0	29,0	21,5	21,5	12,5	1			
05003749001	194008	15,0	29,0	23,5	23,5	12,5	1			
05003750001	194015	16,0	29,0	24,2	23,5	12,5	1			
05003751001	194022	17,0	29,0	26,0	23,5	12,5	1			
05003752001	194039	18,0	29,0	26,5	23,5	12,5	1			
05003753001	194046	19,0	29,0	28,0	23,5	12,5	1			

9607 磁性条带 B Impaktor 1

套筒条带, 含 10 件 Impaktor 套筒扳手, 适合采用电动或气动扳手的应用, 3/8" 驱动。Impaktor 技术即使在极端条件下的使用寿命依旧高于平均水平。

六角端头可传递较高扭矩, 同时确保精密作业, 保护端头。配 “Take it easy” 工具查找装置, 按尺寸进行颜色编码, 可快速方便地找到所需工具。

条带可暂时安装到金属表面, 含旋转解锁功能, 确保安全锁定和解锁套筒。

- 10 件套筒组件含套筒条带, 3/8"
- 条带含便于取用的套筒旋转扣支座, 用于暂时安装到墙壁、柜子、车间用滚轮小车
- 平滑的拧开解锁设计使得套筒的保存更安全, 使用更方便
- 适合采用电动或气动扳手的应用, 3/8" 驱动
- Impaktor 技术, 使用寿命高于平均水平
- 采用六角型面, 可传输高力矩并更精确旋紧操作, 同时可保护花形
- 带十字孔和环状扣环, 可固定套筒的固定销和 O 环
- 带 “易寻” 色标系统, 可轻松找到所需套筒

9607 磁性条带 B Impaktor 1



Code	EAN	mm	mm	mm	mm	mm	mm	mm	mm	mm	
05005451001	227546										
		●	8790 B Impaktor 1x 10,0x30,0; 1x 13,0x30,0; 1x 15,0x30,0; 1x 16,0x30,0; 1x 17,0x30,0; 1x 18,0x30,0; 1x 19,0x30,0; 1x 21,0x32,0; 1x 22,0x32,0; 1x 24,0x32,0								
			9603 1x 30,0x340,0								

9608 磁性条带 B Impaktor Imperial 1

• 英制

9608 磁性条带 B Impaktor Imperial 1



Code	EAN		
05005452001	4013288 227553		1
		8790 B Impaktor 1x 1/4"x30,0; 1x 3/16"x30,0; 1x 3/8"x30,0; 1x 7/16"x30,0; 1x 1/2"x30,0; 1x 9/16"x30,0; 1x 5/8"x30,0; 1x 11/16"x30,0; 1x 3/4"x30,0	
		9601 1x 30,0x340,0	

套筒条带 B 1 Zyklop 套筒组套 · 带固持功能 · 3/8" 驱动

采用维拉的典型设计, 牢固的织物条带内装有9个旋具套筒, 非常节省空间。平滑的拧开解锁设计使得套筒的保存更安全, 使用更方便。

带“易寻”色标系统, 可轻松快速地根据尺寸找到所需套筒。

带弹簧扣, 可以牢固地扣在皮带环或口袋上。带固持功能, 操作方便, 并可防止作业中在接近工件时丢失螺丝。可通过反面的魔术贴将条带附着到墙壁、架子、工具车和维拉2go系列产品上。

- 牢固的织物条带, 内含9个1/4"驱动的旋具套筒
- 操作螺丝、螺栓和螺母时带固持功能
- 平滑的拧开解锁设计使得套筒的保存更安全, 使用更方便
- “易寻”色标系统: 用特定的颜色代表不同端头种类和尺寸
- 可附着到墙壁、架子、工具车和维拉2go系列产品上

套筒条带 B 1 Zyklop 套筒组套 · 带固持功能 · 3/8" 驱动

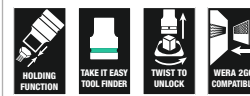

Code	EAN		
05003970001	4013288 194947		1
		8790 HMB HF 1x 8,0x29,0; 1x 10,0x29,0; 1x 12,0x29,0; 1x 13,0x29,0; 1x 15,0x29,0; 1x 16,0x29,0; 1x 17,0x29,0; 1x 18,0x29,0; 1x 19,0x29,0	
		螺帽取出器 1x 14,0x43,0	
		Belt B 0/9 1x 45,0x310,0	
		魔术贴 30 1x 30,0x200,0	

套筒条带 B 4 Zyklop 套筒组套 · 3/8" 驱动

- 牢固的织物条带, 内含9个3/8"驱动的套筒
- 用于手动和非冲击电动工具
- 平滑的拧开解锁设计使得套筒的保存更安全, 使用更方便
- “易寻”色标系统: 用特定的颜色代表不同端头种类和尺寸
- 可附着到墙壁、架子、工具车和维拉2go系列产品上

套筒条带 B 4 Zyklop 套筒组套 · 3/8" 驱动



Code	EAN			
05003973001	4013288 194978			1
		● 8790 HMB 1x 8,0x29,0; 1x 10,0x29,0; 1x 12,0x29,0; 1x 13,0x29,0; 1x 15,0x29,0; 1x 16,0x30,0; 1x 17,0x30,0; 1x 18,0x30,0; 1x 19,0x30,0		
		Belt B 0/9 1x 45,0x310,0		
		魔术贴 30 1x 30,0x200,0		

套筒磁性条带 B 4 Zyklop 套筒组套 · 3/8" 驱动

- 套筒条带, 含 9 件手动和机器操作的套筒 (非冲击), 3/8"。拧转解锁设计, 用于安全收纳并轻松取放套筒。
- 含“易寻”色标系统用特定颜色代表不同刀头花形和尺寸, 有助于轻松快速查找所需工具。

条带可暂时吸附到金属表面, 含拧转解锁设计, 确保安全固定收纳套筒套筒。

- 9 件套筒组件含套筒条带, 3/8"
- 条带含便于取用的套筒旋转扣支座, 用于暂时安装到墙壁、柜子、车间用滚轮小车
- 平滑的拧开解锁设计使得套筒的保存更安全, 使用更方便
- 带“易寻”色标系统, 可轻松找到所需套筒

套筒磁性条带 B 4 Zyklop 套筒组套 · 3/8" 驱动



Code	EAN			
05005430001	4013288 223234			1
		● 8790 HMB 1x 8,0x29,0; 1x 10,0x29,0; 1x 12,0x29,0; 1x 13,0x29,0; 1x 15,0x29,0; 1x 16,0x30,0; 1x 17,0x30,0; 1x 18,0x30,0; 1x 19,0x30,0		
		9601 1x 30,0x340,0		

套筒磁性条带 B Imperial 1 Zyklus 套筒组套 · 3/8" 驱动 · 英制

套筒条带, 含9件手动和机器操作的套筒 (非冲击), 3/8"。拧转解锁设计, 用于安全收纳并轻松取放套筒。

含“易寻”色标系统用特定颜色代表不同刀头花形和尺寸, 有助于轻松快速查找所需工具。

条带可暂时吸附到金属表面, 含拧转解锁设计, 确保安全固定收纳套筒套筒。

- 9 件套筒组件含套筒条带, 3/8"
- 条带含便于取用的套筒旋转扣支座, 用于暂时安装到墙壁、柜子、车间用滚轮小车
- 平滑的拧开解锁设计使得套筒的保存更安全, 使用更方便
- 带“易寻”色标系统, 可轻松找到所需套筒

套筒磁性条带 B Imperial 1 Zyklus 套筒组套 · 3/8" 驱动 · 英制



Code	EAN		
05005450001	223258		1
		8790 HMB 1x 1/4"x29,0; 1x 5/16"x29,0; 1x 11/32"x29,0; 1x 3/8"x29,0; 1x 7/16"x29,0; 1x 1/2"x29,0; 1x 9/16"x29,0; 1x 5/8"x30,0; 1x 3/4"x30,0	
		9601 1x 30,0x340,0	

8790 HMB Deep 3/8" 加长型套筒

加长型 3/8" 手动和机械用套筒 (ISO 2725 第3部分) 内藏卡位球锁; 用于外六角螺栓和套筒。用于手动和机器操作 (非敲击型), 可应用于低位紧固和凸头螺纹杆。带“易寻”色标系统, 可轻松找到所需套筒。即便是手上有油, 也能轻松握持。与双六角形批头相比, 此六角形批头允许强大的传输力量及减少螺栓边缘或螺丝头的形变。尽管在有限空间内, 由于它的小后回转角度, 细齿棘轮让双六角形变得多余。

- 长型扳手用于低位旋紧, 甚至可以应用在狭小空间的凸头螺纹杆上。
- 采用六角型面, 可实现高力矩传输的精确螺栓紧固操作, 同时对螺丝帽凹槽部分提供了更良好的保护
- “易寻”色标系统: 用特定的颜色代表不同端头种类和尺寸
- 尾部滚花以便于手指握持操作
- 用于手动和机器运行 (非冲击型), 球型档环
- 采用亚光镀铬的铬钒合金材质

8790 HMB Deep 3/8" 加长型套筒



Code	EAN		mm	mm	mm	mm	
05004530001	210388		8,0	64,0	12,2	17,0	1
05004531001	210395		9,0	64,0	13,5	17,0	1
05004532001	210401		10,0	64,0	14,5	17,0	1
05004533001	210418		11,0	64,0	15,7	17,0	1
05004534001	210425		12,0	64,0	16,5	18,0	1
05004535001	210432		13,0	64,0	19,0	17,0	1
05004536001	210449		14,0	64,0	20,0	18,0	1
05004537001	210456		15,0	64,0	22,0	20,0	1
05004538001	210463		16,0	64,0	22,0	20,0	1
05004539001	210470		17,0	64,0	24,0	22,0	1
05004540001	210487		18,0	64,0	26,0	23,0	1
05004541001	210494		19,0	64,0	26,0	23,0	1
05004542001	210500		20,0	64,0	28,0	25,0	1
05004543001	210517		21,0	64,0	28,0	25,0	1
05004544001	210524		22,0	64,0	30,0	26,0	1

套筒条带 B 1 Deep 套筒组套 · 3/8" 驱动

牢固耐用的织物带，采用典型的Wera设计，具有9长型3/8英寸手动和机器套筒插件（非抗冲击型）可用于狭小空间。更为顺滑的旋转机构，可确保稳固的握持效果，同时方便取下套筒。随附用于连接到束带圈或工具包的挂钩。采用纤维网底面以及弯钩和环扣带，安装方便，例如可安装在墙壁、置物架、工具小车或Wera 2go工具运输系统。

Wera出品的长型1/4英寸、3/8英寸、3/8英寸手动和机器套筒扳手插口（ISO 2725 第3部分），适用于手动和机器操作（非敲击型），也可采用低位旋拧和凸头螺纹杆。通过简单易用的工具寻找器，采用基于尺寸的颜色编码-可快速方便地找到所需工具。

即便是手上有油，也能轻松握紧。具有六角型面和球头固定槽。与双六角形批头相比，此六角形批头允许强大的传输力量及减少螺栓边缘或螺丝头的形变。尽管在有限空间内，由于它的小后回转角度，细齿棘轮让双六角形变得多余。用于外六角螺栓和套筒。

- 9件套筒组件，采用牢固耐用的织物工具带，3/8"
- 平滑的拧开解锁设计使得套筒的保存更安全，使用更方便
- 加长型3/8"手动和机械（非抗冲击型）套筒，用于紧凑结构空间内的低挡位的螺纹配合连接，以及凸头螺纹杆
- 采用六角型面，可更有效的实现高力矩传输的精确紧固操作，同时可保护工具表面。
- “易寻”色标系统：用特定的颜色代表不同端头种类和尺寸

套筒条带 B 1 Deep 套筒组套 · 3/8" 驱动



Code	EAN		
05004545001	4013288 210555		1
		● 8790 HMB Deep 1x 8,0x64,0; 1x 10,0x64,0; 1x 12,0x64,0; 1x 13,0x64,0; 1x 15,0x64,0; 1x 16,0x64,0; 1x 17,0x64,0; 1x 18,0x64,0; 1x 19,0x64,0	
		● Belt B 0/9 1x 45,0x310,0	
		● 魔术贴 30 1x 30,0x200,0	

套筒磁性条带 B Deep 1 套筒组套 · 3/8" 驱动

套筒条带，含 9 件手动和机器操作用的长型套筒（非冲击），3/8"。

拧转解锁设计，用于安全收纳并轻松取放套筒。维拉长型 3/8" 手动和机器操作用的套筒（ISO 2725 第 3 部分）允许手动和（非冲击）机械用，用于难以触及的连接件和伸出的螺纹杆。

含“易寻”色标系统用特定颜色代表不同刀头花形和尺寸，有助于轻松快速查找所需工具。

采用防滑设计，即使手上有油也可轻松持握。

带六角端头和球锁。六角端头可实现高力度传递，螺栓或螺丝边缘的负荷比双六角花形小。

由于细齿棘轮的反向旋转角度较小，可在密闭空间内作业，因此也不需要双六角花形。

用于外六角螺栓和螺丝。条带可暂时吸附到金属表面，含拧转解锁设计，确保安全固定收纳套筒套筒。

- 9 件套筒组件含套筒条带，3/8"
- 条带含便于取用的套筒旋转扣支座，用于暂时安装到墙壁、柜子、车间用滚轮小车
- 平滑的拧开解锁设计使得套筒的保存更安全，使用更方便
- 加长型3/8"手动和机械（非抗冲击型）套筒，用于紧凑结构空间内的低挡位的螺纹配合连接，以及凸头螺纹杆
- 采用六角型面，可传输高力矩并更精确旋紧操作，同时可保护花形

套筒磁性条带 B Deep 1 套筒组套 · 3/8" 驱动



Code	EAN		
05005440001	4013288 223241		1
		● 8790 HMB Deep 1x 8,0x64,0; 1x 10,0x64,0; 1x 12,0x64,0; 1x 13,0x64,0; 1x 15,0x64,0; 1x 16,0x64,0; 1x 17,0x64,0; 1x 18,0x64,0; 1x 19,0x64,0	
		● 9601 1x 30,0x340,0	

8767 B HF TORX® Zyklop 套筒 · 3/8" 驱动 · 带固持功能

- 旋具套筒 (非冲击), 用于手动和机动工具
- 固持功能确保螺丝牢固黏着在工具上
- “易寻”色标系统: 用特定的颜色代表不同端头种类和尺寸
- 尾部滚花以便于手指握持操作
- 高品质铬钒钢, 亚光镀铬

8767 B HF TORX® Zyklop 套筒 · 3/8" 驱动 · 带固持功能



Code	EAN						
05003059001	189097		TX 10	35,0	12,0	17,5	1
05003060001	188830		TX 15	35,0	12,0	17,5	1
05003061001	188847		TX 20	35,0	12,0	17,5	1
05003062001	188854		TX 25	35,0	12,0	17,5	1
05003063001	188861		TX 25	107,0	12,0	17,5	1
05003064001	188878		TX 27	35,0	12,0	17,5	1
05003065001	188885		TX 27	107,0	12,0	17,5	1
05003066001	188892		TX 30	35,0	12,0	17,5	1
05003067001	188908		TX 30	107,0	12,0	17,5	1
05003068001	188915		TX 40	35,0	12,0	17,5	1
05003069001	188922		TX 40	107,0	12,0	17,5	1
05003070001	188939		TX 45	38,5	12,0	17,5	1
05003071001	188946		TX 45	100,0	12,0	17,5	1
05003072001	188953		TX 50	38,5	12,0	17,5	1
05003073001	188960		TX 50	100,0	12,0	17,5	1

8767 B TORX® Zyklop 批头套筒 · 配 3/8" 驱动和和极细刀头

- 旋具套筒 (非冲击), 用于手动和机动工具
- 固持功能确保螺丝牢固黏着在工具上
- 带 “易寻” 色标系统, 可轻松找到所需套筒
- 尾部滚花以便于手指握持操作。
- 高品质铬钒钢, 亚光镀铬

8767 B TORX® Zyklop 批头套筒 · 配 3/8" 驱动和和极细刀头



Code	EAN							
05003074001	227102		TX 25	107,0	12,0	17,5	81,5	1
05003075001	227119		TX 30	107,0	12,0	17,5	81,5	1

套筒条带 B 3 TORX® HF Zyklop 旋具套筒组套 · 带固持功能 · 3/8" 驱动

采用维拉的典型设计, 牢固的织物条带内装有9个套筒, 非常节省空间。平滑的拧开解锁设计使得套筒的保存更安全, 使用更方便。

带“易寻”色标系统, 可轻松快速地根据尺寸找到所需套筒。带弹簧扣, 可以牢固地扣在皮带环或口袋上。

坚固的超短型旋具套筒, 拥有维拉批头技术的所有优点。带固持功能, 操作方便, 并可防止作业中在接近工件时丢失螺丝。可通过反面的魔术贴将条带附着到墙壁、架子、工具车和维拉2go系列产品上。

- 牢固的织物条带, 内含9个3/8"驱动的旋具套筒
- 拥有维拉批头技术的所有优点
- 操作螺丝、螺栓时带固持功能
- 平滑的拧开解锁设计使得套筒的保存更安全, 使用更方便
- 可附着到墙壁、架子、工具车和维拉2go系列产品上

套筒条带 B 3 TORX® HF Zyklop 旋具套筒组套 · 带固持功能 · 3/8" 驱动



Code	EAN		
05003972001	4013288 194961		1
			8767 B HF 1x TX 10x35,0; 1x TX 15x35,0; 1x TX 20x35,0; 1x TX 25x35,0; 1x TX 27x35,0; 1x TX 30x35,0; 1x TX 40x35,0; 1x TX 45x38,5; 1x TX 50x38,5
			Belt B 0/9 1x 45,0x310,0
			魔术贴 30 1x 30,0x200,0

8767 B TORX® HF 1 Zyklop 旋具套筒组套 · 带固持功能 · 3/8" 驱动

- 带固持功能的旋具套筒, 适用于TORX®螺丝
- 固持功能确保螺丝牢固黏着在工具上
- “易寻”色标系统: 用特定的颜色代表不同端头种类和尺寸
- 套筒尾部滚花以便于手指握持操作

8767 B TORX® HF 1 Zyklop 旋具套筒组套 · 带固持功能 · 3/8" 驱动

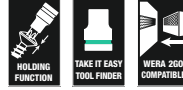

Code	EAN		
05003185001	4013288 195074		1
			8767 B HF 1x TX 25x107,0; 1x TX 27x107,0; 1x TX 30x107,0; 1x TX 40x107,0; 1x TX 45x100,0; 1x TX 50x100,0
			魔术贴 120 1x 50,0x120,0

8740 B HF Zyklop 套筒 · 3/8" 驱动 · 带固持功能

- 旋具套筒 (非冲击), 用于手动和机动工具
- 固持功能确保螺丝牢固黏着在工具上
- “易寻”色标系统: 用特定的颜色代表不同端头种类和尺寸

8740 B HF Zyklop 套筒 · 3/8" 驱动 · 带固持功能



Code	EAN	Hex	Hex	Length	Length	Length	Length	Length
05003030001	188557	3,0		35,0	12,0	17,5	1	
05003031001	188564	4,0		35,0	12,0	17,5	1	
05003032001	188571	4,0		107,0	12,0	17,5	1	
05003033001	188649	5,0		35,0	12,0	17,5	1	
05003034001	188656	5,0		107,0	12,0	17,5	1	
05003035001	188663	6,0		35,0	12,0	17,5	1	
05003036001	188731	6,0		107,0	12,0	17,5	1	
05003037001	188748	7,0		38,5	12,0	17,5	1	
05003038001	188755	7,0		100,0	12,0	17,5	1	
05003039001	188779	8,0		38,5	12,0	17,5	1	
05003040001	188786	8,0		100,0	12,0	17,5	1	
05003041001	188793	9,0		38,5	12,0	17,5	1	
05003042001	188809	9,0		100,0	12,0	17,5	1	
05003043001	188816	10,0		38,5	12,0	17,5	1	
05003044001	188823	10,0		100,0	12,0	17,5	1	
05003080001	193407		1/8"	35,0	12,0	17,5	1	
05003081001	193414		1/8"	107,0	12,0	17,5	1	
05003082001	193421		9/64"	35,0	12,0	17,5	1	
05003083001	193438		5/32"	35,0	12,0	17,5	1	
05003084001	193445		5/32"	107,0	12,0	17,5	1	
05003085001	193452		3/16"	35,0	12,0	17,5	1	
05003086001	193551		3/16"	107,0	12,0	17,5	1	
05003087001	193568		7/32"	35,0	12,0	17,5	1	
05003088001	193575		7/32"	107,0	12,0	17,5	1	
05003089001	193612		1/4"	35,0	12,0	17,5	1	
05003090001	193629		1/4"	107,0	12,0	17,5	1	
05003091001	193636		5/16"	38,5	12,0	17,5	1	
05003092001	193643		5/16"	100,0	12,0	17,5	1	
05003093001	193650		3/8"	38,5	12,0	17,5	1	
05003094001	193667		3/8"	100,0	12,0	17,5	1	

8740 B Zyklop 批头套筒 · 配 3/8" 驱动和极细刀头

- 旋具套筒 (非冲击), 用于手动和机动工具
- 固持功能确保螺丝牢固黏着在工具上
- 带 “易寻” 色标系统, 可轻松找到所需套筒

8740 B Zyklop 批头套筒 · 配 3/8" 驱动和极细刀头

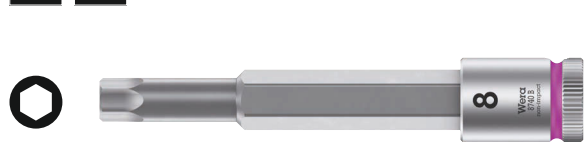

Code	EAN	Hex	Hex	Length	Length	Length	Length	Length
05003050001	227058	4,0		107,0	12,0	17,5	81,5	1
05003051001	227065	5,0		107,0	12,0	17,5	81,5	1
05003052001	227072	6,0		107,0	12,0	17,5	81,5	1
05003054001	227089	8,0		100,0	12,0	17,5	74,5	1
05003056001	227096	10,0		100,0	12,0	17,5	74,5	1

套筒条带 B 2 Zyklop 增强型内六角旋具套筒组套 · 带固持功能 · 3/8" 驱动

采用维拉的典型设计, 牢固的织物条带内装有8个内六角旋具套筒, 非常节省空间。

平滑的拧开解锁设计使得套筒的保存更安全, 使用更方便。

带“易寻”色标系统, 可轻松快速地根据尺寸找到所需套筒。带弹簧扣, 可以牢固地扣在皮带环或口袋上。

可通过反面的魔术贴将条带附着到墙壁、架子、工具车和维拉2go系列产品上。

- 牢固的织物条带, 内含8个3/8"驱动的旋具套筒
- 拥有维拉批头技术的所有优点
- 操作螺丝、螺栓时带固持功能
- 平滑的拧开解锁设计使得套筒的保存更安全, 使用更方便
- 可附着到墙壁、架子、工具车和维拉2go系列产品上

套筒条带 B 2 Zyklop 增强型内六角旋具套筒组套 · 带固持功能 · 3/8" 驱动



Code	EAN		
05003971001	4013288 194954		1
		8740 B HF 1x 3,0x35,0; 1x 4,0x35,0; 1x 5,0x35,0; 1x 6,0x35,0; 1x 7,0x38,5; 1x 8,0x38,5; 1x 9,0x38,5; 1x 10,0x38,5	
		Belt B 0/8 1x 45,0x275,0	
		魔术贴 30 1x 30,0x200,0	

8740 B HF 1 Zyklop 旋具套筒组套 · 带固持功能 · 3/8" 驱动

- 紧凑而极为坚固的织物盒包装, 体积小而轻便
- 旋具套筒 (非冲击), 用于手动和电动工具
- 固持功能确保螺丝牢固黏着在工具上
- “易寻”色标系统: 用特定的颜色代表不同端头种类和尺寸
- 套筒尾部滚花以便于手指握持操作
- 加长型设计

8740 B HF 1 Zyklop 旋具套筒组套 · 带固持功能 · 3/8" 驱动



Code	EAN		
05003180001	4013288 195050		1
		8740 B HF 1x 4,0x107,0; 1x 5,0x107,0; 1x 6,0x107,0; 1x 7,0x100,0; 1x 8,0x100,0; 1x 9,0x100,0; 1x 10,0x100,0	
		魔术贴 120 1x 50,0x120,0	

8740 B HF Imperial 1 Zyklop 旋具套筒组套 · 带固持功能 · 3/8" 驱动

- 长款
- 英制

8740 B HF Imperial 1 Zyklop 旋具套筒组套 · 带固持功能 · 3/8" 驱动



Code		EAN		
		4013288		
05003181001	195067			1
		8740 B HF 1x 1/8"x107,0; 1x 5/32"x107,0; 1x 3/16"x107,0; 1x 7/32"x107,0; 1x 1/4"x107,0; 1x 5/16"x100,0; 1x 3/8"x100,0		
		魔术贴 120 1x 50,0x120,0		

套筒条带 B Imperial 1 Zyklop 增强型内六角旋具套筒组套 · 带固持功能 · 3/8" 驱动

采用维拉的典型设计, 牢固的织物条带内装有8个内六角旋具套筒, 非常节省空间。

平滑的拧开解锁设计使得套筒的保存更安全, 使用更方便。

带“易寻”色标系统, 可轻松快速地根据尺寸找到所需套筒。带弹簧扣, 可以牢固地扣在皮带环或口袋上。

可通过反面的魔术贴将条带附着到墙壁、架子、工具车和维拉2go系列产品上。

- 牢固的织物条带, 内含8个3/8"驱动的旋具套筒
- 拥有维拉批头技术的所有优点
- 操作螺丝、螺栓时带固持功能
- 平滑的拧开解锁设计使得套筒的保存更安全, 使用更方便
- 可附着到墙壁、架子、工具车和维拉2go系列产品上
- 英制

套筒条带 B Imperial 1 Zyklop 增强型内六角旋具套筒组套 · 带固持功能 · 3/8" 驱动



Code		EAN		
		4013288		
05003974001	194985			1
		8740 B HF 1x 1/8"x35,0; 1x 3/64"x35,0; 1x 5/32"x35,0; 1x 3/16"x35,0; 1x 7/32"x35,0; 1x 1/4"x35,0; 1x 5/16"x38,5; 1x 3/8"x38,5		
		Belt B 0/8 1x 45,0x275,0		
		魔术贴 30 1x 30,0x200,0		

自行车组套 8

7 件批头套筒组套，配 $\frac{3}{8}$ " 驱动，用于常规自行车作业。批头套筒，配 30mm 极细刀头，更适合狭窄工作空间。

滚花有助于人工拧紧作业不打滑。含“易寻”色标系统用特定颜色代表不同刀头种类和尺寸，有助于轻松快速查找所需工具。

- 批头套筒，含固持功能，用于最常规的 TORX® 螺丝和 Hex 螺丝
- 固持功能确保螺丝牢固黏着在工具上
- 带“易寻”色标系统，可轻松找到所需套筒
- 套筒尾部滚花以便于手指握持操作
- 置于坚固折叠袋内，便于运输

自行车组套 8



Code	EAN				
05004176001	4013288 220622				1
		⊗	8767 B 1x TX 25x107,0; 1x TX 30x107,0		
		○	8740 B 1x 4,0x107,0; 1x 5,0x107,0; 1x 6,0x107,0; 1x 8,0x100,0; 1x 10,0x100,0		
			魔术贴 120 1x 50,0x70,0		

8796 LB Zyklop 快速锁定延长杆，带自由旋转护套，长型， $\frac{3}{8}$ "

- 用于 $\frac{3}{8}$ "内四方，带球锁
- 快速锁定装置即可锁定、也可快速更换套筒
- 带自由旋转护套，可快速紧固和松开螺丝螺母

8796 LB Zyklop 快速锁定延长杆，带自由旋转护套，长型， $\frac{3}{8}$ "



Code	EAN						
05003592001	4013288 121325	⊗	mm 200,0				1

8796 SB Zyklop 快速锁定延长杆，带自由旋转护套，短型， $\frac{3}{8}$ "

- 快速锁定装置即可锁定、也可快速更换套筒
- 用于 $\frac{3}{8}$ "内四方，带球锁
- 带自由旋转护套，可快速紧固和松开螺丝螺母

8796 SB Zyklop 快速锁定延长杆，带自由旋转护套，短型， $\frac{3}{8}$ "



Code	EAN						
05003591001	4013288 121318	⊗	mm 125,0				1

8794 LB Zyklop 延长杆，带自由旋转护套，长型， $\frac{3}{8}$ "

$\frac{3}{8}$ " Zyklop延长杆，带自由旋转护套，长型。自由旋转护套可有效加速螺丝和螺帽的装卸过程。

8794 LB Zyklop 延长杆，带自由旋转护套，长型， $\frac{3}{8}$ "



Code	EAN	尺寸	长度	重量	包装
05003583001	121288	$\frac{3}{8}$ "	200,0		1

8794 SB Zyklop 延长杆，带自由旋转护套，短型， $\frac{3}{8}$ "

自由旋转护套可有效加速螺丝和螺帽的装卸过程。

8794 SB Zyklop 延长杆，带自由旋转护套，短型， $\frac{3}{8}$ "



Code	EAN	尺寸	长度	重量	包装
05003582001	121271	$\frac{3}{8}$ "	125,0		1

8789 B Zyklop T型滑动手柄， $\frac{3}{8}$ "

$\frac{3}{8}$ " Zyklop T型滑动手柄，带手柄驱动。用于 $\frac{3}{8}$ "内四方，带球锁。高品质铬钒钢，亚光镀铬。

8789 B Zyklop T型滑动手柄， $\frac{3}{8}$ "



Code	EAN	尺寸	长度	重量	包装
05003581001	121516	$\frac{3}{8}$ "	165,0		3

8795 B Zyklop 万向接头， $\frac{3}{8}$ "

$\frac{3}{8}$ " Zyklop万向接头。用于 $\frac{3}{8}$ "内四方，带球锁。高品质铬钒/铬钼钢，亚光镀铬。

8795 B Zyklop 万向接头， $\frac{3}{8}$ "



Code	EAN	尺寸	长度	重量	包装
05003585001	121523	$\frac{3}{8}$ "	50,0		1

8794 B Zyklop 摆动延长杆， $\frac{3}{8}$ "

Zyklop摆动式延长杆可以在 15° 的范围内活动，使得工具可在隐蔽或封闭的安装区域内快速而精确地工作。

8794 B Zyklop 摆动延长杆， $\frac{3}{8}$ "



Code	EAN	尺寸	长度	重量	包装
05003584001	121295	$\frac{3}{8}$ "	76,0		1

8784 B1 Zyklop 批头用转接头， $\frac{3}{8}$ "

• $\frac{3}{8}$ " Zyklop转接头，带快速接头，可快速更换批头

8784 B1 Zyklop 批头用转接头， $\frac{3}{8}$ "



Code	EAN	尺寸	长度	重量	包装
05003590001	121301	$\frac{1}{4}$ "	$\frac{3}{8}$ "	44,0	1

套筒条带 (织物带) B · 8个位置



Code	EAN		
05003980001	4013288 195005		1
		Belt B 0/8 1x 45,0x275,0	
		魔术贴 30 1x 30,0x200,0	

套筒条带 (织物带) B · 9个位置



Code	EAN		
05003981001	4013288 195012		1
		Belt B 0/9 1x 45,0x310,0	
		魔术贴 30 1x 30,0x200,0	

9601磁性 套筒条带 · 3/8" · 空

1 套筒条带, 空。用于至多 10 件套筒和/或批头套筒, 3/8" 驱动。

条带可暂时吸附到金属表面, 含拧转解锁设计, 确保安全固定收纳套筒套筒。

- 条带含便于取用的套筒旋转扣支座, 用于暂时安装到墙壁、柜子、车间用滚轮小车
- 平滑的拧开解锁设计使得套筒的保存更安全, 使用更方便
- 空, 用于至多 10 件套筒, 3/8"

9601磁性 套筒条带 · 3/8" · 空

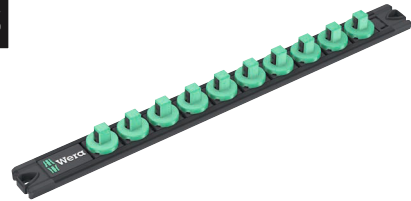

Code	EAN	mm	mm				
05136421001	4013288 223333	30,0	340,0				1

Zyklop Speed - 无法置信的快速和灵活

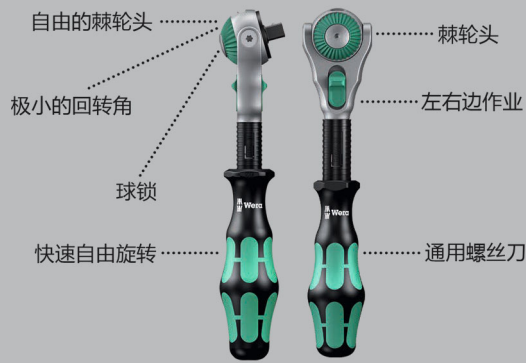

织布包装更加便于携带, 更节省空间, 这意味着存放同样工具的组套拥有更小更舒适的包装。

新包装寻找工具更加方便, 同时比以往任何一种包装形式都更加轻巧便携。

这种包装的保护性能使得里面的工具在织布包掉落时不会因相互碰撞而带来伤害。

- 可自由转动的棘轮头, 带5种预设的锁定位置
- 72细齿
- 小至5°的回转角
- 自由旋转护套, 可高效作业
- “易寻”色标系统: 用特定的颜色代表不同端头种类和尺寸
- 紧凑而极为坚固的织物盒包装, 体积小而轻便

8100 SC 6 Zyklop Speed 棘轮扳手套组 · 1/2" 驱动 · 公制



Code	EAN		
	4013288		
05004076001	173874		1
		8000 C 1x 1/2"x277,0	
		8790 HMC 1x 10,0x37,0; 1x 11,0x37,0; 1x 12,0x37,0; 1x 13,0x37,0; 1x 14,0x37,0; 1x 15,0x37,0; 1x 16,0x37,0; 1x 17,0x37,0; 1x 18,0x37,0; 1x 19,0x37,0	
		8794 LC 1x 1/2"x250,0	
		8794 C 1x 1/2"x52,0	
		8784 C2 1x 9/16"x1/2"x50,0	
		851/2 Z PH 1x PH 2x32; 1x PH 3x32	
		855/2 Z PZ 1x PZ 2x32; 1x PZ 3x32	
		867/2 Z TORX® 1x TX 20x35; 1x TX 25x35; 1x TX 30x35; 1x TX 40x35; 1x TX 45x35; 1x TX 50x35	
		840/2 Z 1x 5x30; 1x 6x30; 1x 8x30; 1x 10x30	

8100 SC 9 Zyklop Speed 棘轮扳手组套 · 1/2" 驱动 · 英制



Code	EAN			
05004079001	173997			1
		<input type="checkbox"/> 8000 C 1x 1/2"x277,0		
		<input checked="" type="checkbox"/> 8790 HMC 1x 3/8"x37,0; 1x 7/16"x37,0; 1x 1/2"x37,0; 1x 9/16"x37,0; 1x 19/32"x37,0; 1x 5/8"x37,0; 1x 11/16"x37,0; 1x 3/4"x37,0; 1x 25/32"x37,0; 1x 13/16"x37,0		
		<input checked="" type="checkbox"/> <input checked="" type="checkbox"/> 8794 LC 1x 1/2"x250,0		
		<input checked="" type="checkbox"/> <input checked="" type="checkbox"/> 8794 C 1x 1/2"x52,0		
		<input checked="" type="checkbox"/> <input checked="" type="checkbox"/> 8784 C2 1x 5/16"x1/2"x50,0		
		<input checked="" type="checkbox"/> 851/2 Z PH 1x PH 2x32; 1x PH 3x32		
		<input checked="" type="checkbox"/> 855/2 Z PZ 1x PZ 2x32; 1x PZ 3x32		
		<input checked="" type="checkbox"/> 867/2 Z TORX® 1x TX 20x35; 1x TX 25x35; 1x TX 30x35; 1x TX 40x35; 1x TX 45x35; 1x TX 50x35		
		<input checked="" type="checkbox"/> 840/2 Z 1x 7/32"x30; 1x 1/4"x30; 1x 5/16"x30; 1x 3/8"x30		

8100 SC 2 Zyklop Speed 棘轮扳手组套 · 1/2" 驱动 · 公制

- 37件套, 坚固的金属工具箱

8100 SC 2 Zyklop Speed 棘轮扳手组套 · 1/2" 驱动 · 公制



Code	EAN			
05003645001	121189			1
		<input type="checkbox"/> 8000 C 1x 1/2"x277,0		
		<input checked="" type="checkbox"/> 8790 HMC 1x 10,0x37,0; 1x 11,0x37,0; 1x 12,0x37,0; 1x 13,0x37,0; 1x 14,0x37,0; 1x 15,0x37,0; 1x 16,0x37,0; 1x 17,0x37,0; 1x 18,0x37,0; 1x 19,0x37,0; 1x 20,0x37,0; 1x 21,0x37,0; 1x 22,0x37,0; 1x 24,0x37,0; 1x 27,0x40,0; 1x 30,0x42,0; 1x 32,0x42,0		
		<input type="checkbox"/> 8789 C 1x 1/2"x250,0		
		<input checked="" type="checkbox"/> <input checked="" type="checkbox"/> 8794 C 1x 1/2"x52,0		
		<input checked="" type="checkbox"/> <input checked="" type="checkbox"/> 8795 C 1x 1/2"x69,0		
		<input checked="" type="checkbox"/> <input checked="" type="checkbox"/> 8784 C2 1x 5/16"x1/2"x50,0		
		<input checked="" type="checkbox"/> <input checked="" type="checkbox"/> 8796 SC 1x 1/2"x125,0		
		<input checked="" type="checkbox"/> <input checked="" type="checkbox"/> 8796 LC 1x 1/2"x250,0		
		<input checked="" type="checkbox"/> 851/2 Z PH 1x PH 3x32		
		<input checked="" type="checkbox"/> 855/2 Z PZ 1x PZ 3x32		
		<input checked="" type="checkbox"/> 867/2 Z TORX® 1x TX 20x35; 1x TX 25x35; 1x TX 30x35; 1x TX 40x35; 1x TX 45x35; 1x TX 50x35; 1x TX 55x35		
		<input checked="" type="checkbox"/> 840/2 Z 1x 5x30; 1x 6x30; 1x 8x30; 1x 10x30		

8100 SC 4 Zyklop Speed 棘轮扳手组套 ·
1/2" 驱动 · 英制

- 38件套, 坚固的金属工具箱装

8100 SC 4 Zyklop Speed 棘轮扳手组套 · 1/2" 驱动 · 英制



Code	EAN		
05003647001	121202		1
		□ 8000 C 1x 1/2"x277,0	
		● 8790 HMC 1x 3/8"x37,0; 1x 7/16"x37,0; 1x 1/2"x37,0; 1x 9/16"x37,0; 1x 19/32"x37,0; 1x 5/8"x37,0; 1x 11/16"x37,0; 1x 3/4"x37,0; 1x 25/32"x37,0; 1x 13/16"x37,0; 1x 7/8"x37,0; 1x 15/16"x37,0; 1x 31/32"x37,0; 1x 1"x40,0; 1x 1 1/16"x40,0; 1x 1 1/8"x40,0; 1x 1 3/16"x42,0; 1x 1 1/4"x42,0	
		□ 8789 C 1x 1/2"x250,0	
		● □ 8794 C 1x 1/2"x52,0	
		● □ 8795 C 1x 1/2"x69,0	
		● □ 8784 C2 1x 5/16"x1/2"x50,0	
		● □ 8796 SC 1x 1/2"x125,0	
		● □ 8796 LC 1x 1/2"x250,0	
		+ 851/2 Z PH 1x PH 3x32	
		+ 855/2 Z PZ 1x PZ 3x32	
		+ 867/2 Z TORX® 1x TX 20x35; 1x TX 25x35; 1x TX 30x35; 1x TX 40x35; 1x TX 45x35; 1x TX 50x35; 1x TX 55x35	
		○ 840/2 Z 1x 7/32"x30; 1x 1/4"x30; 1x 5/16"x30; 1x 3/8"x30	

8000 C Zyklop Speed 棘轮扳手 ·
1/2" 驱动

- 集物种不同的棘轮功能于一身
- 飞轮的设计和易于抓握的自由旋转护套提高了工作效率
- 可自由转动的棘轮头, 按钮释放, 可拨杆左右换向
- 细齿结构得到小至5°的回转角
- 也可用作螺丝刀

8000 C Zyklop Speed 棘轮扳手 · 1/2" 驱动



Code	EAN						
05003600001	121882	1/2"	277,0				1

8000 C Zyklop Speed 棘轮扳手吊卡装 · 1/2" 驱动



Code	EAN			
05073262001	128058	□	8000 C 1x 1/2"x277,0	3

Zyklop 混合棘轮扳手 – 更大扭力

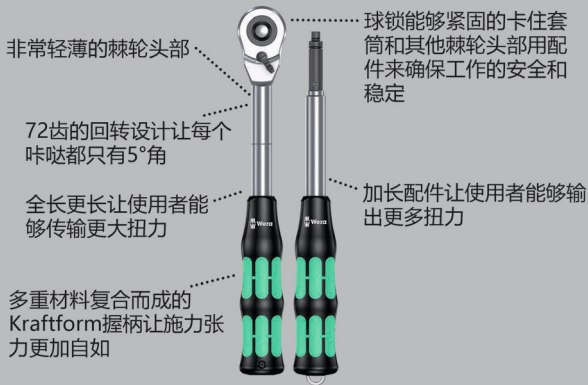

1个1/2"驱动的Zyklop Hybrid棘轮扳手, 10个带固持功能的Zyklop套筒, 1个带释放销的Zyklop Hybrid延长杆, 1个带自由旋转护套的Zyklop延长杆 (长款)。

- 拨杆便于换向
- Zyklop Metal 拨杆式: 72细齿棘轮具有小至5°的回转角, 这样的短行程使其可快速而精确地进行几乎所有类型的安装作业
- 紧凑而极为坚固的织物盒包装, 体积小而轻便
- 套筒带颜色标识不同尺寸
- 平滑的拧开解锁设计使得套筒的保存更安全, 使用更方便

8006 SC 1 Zyklop Hybrid棘轮扳手套组 · 1/2" 驱动 · 公制



Code	EAN				
05004090001	4013288				1
		8006 C	1x 1/2"x281,0		
		8797 C	1x 271,0		
		8794 LC	1x 1/2"x250,0		
		8790 HMC HF	1x 10,0x37,0; 1x 11,0x37,0; 1x 12,0x37,0; 1x 13,0x37,0; 1x 14,0x37,0; 1x 15,0x37,0; 1x 16,0x37,0; 1x 17,0x37,0; 1x 18,0x37,0; 1x 19,0x37,0		
		魔术贴 240	1x 50,0x240,0		

Zyklop Hybrid 组套

外接延长杆可传递更大扭矩。

- Zyklop Hybrid棘轮扳手总长长而省力, 棘轮头纤细
- Zyklop Metal 拨杆式: 72细齿棘轮具有小至5°的回转角, 这样的短行程使其可快速而精确地进行几乎所有类型的安装作业。
- 延长杆带释放销

Zyklop Hybrid 组套

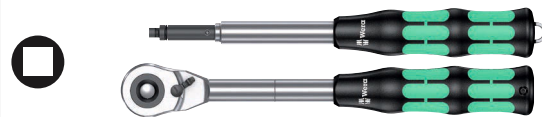

Code	EAN			
05004095001	4013288			1
	184320	8006 C	1x 1/2"x281,0	
		8797 C	1x 271,0	

8006 C Zyklop Hybrid拨杆换向棘轮扳手 · 1/2" 驱

- Zyklop Hybrid棘轮扳手总长长而省力, 棘轮头纤细
- 72细齿棘轮具有小至5°的回转角, 这样的短行程使其可快速而精确地进行几乎所有类型的安装作业

8006 C Zyklop Hybrid拨杆换向棘轮扳手 · 1/2" 驱动



Code	EAN						
05003780001	4013288		mm	mm	mm		3
	184214	1/2"	281,0	34	37		

8797 C Zyklop Hybrid 延长杆

- 可配合Zyklop Hybrid 8006 C使用
- 可增加传递的扭力
- Kraftform多重材料手柄, 有效抵抗压力和拉伸载荷
- 带释放销
- 具有韧性, 回火铬钼钢锻造

8797 C Zyklop Hybrid 延长杆



	EAN	⌀	ℓ						
Code	4013288	mm	mm						
05003781001	1832200	271,0	134,0						1

Zyklop Metal推杆式棘轮扳手



织布包装更加便于携带, 更节省空间, 这意味着存放同样工具的组套拥有更小更舒适的包装。

新包装寻找工具更加方便, 同时比以往任何一种包装形式都更加轻巧便携。

这种包装的保护性能使得里面的工具在织布包掉落时不会因相互碰撞而带来伤害。

- 棘轮扳手极为纤细、省力
- 小至4.7°的回转角
- 非拆卸式的推杆头可平滑转换
- “易寻”色标系统

8100 SC 7 Zyklop Metal推杆换向棘轮扳手组套 · 1/2" 驱动 · 驱动 · 公制



Code	EAN		
05004077001	173942		1
		<ul style="list-style-type: none"> 8003 C 1x 1/2"x281,0 	
		<ul style="list-style-type: none"> 8790 HMC 1x 10,0x37,0; 1x 11,0x37,0; 1x 12,0x37,0; 1x 13,0x37,0; 1x 14,0x37,0; 1x 15,0x37,0; 1x 16,0x37,0; 1x 17,0x37,0; 1x 18,0x37,0; 1x 19,0x37,0 	
		<ul style="list-style-type: none"> 8794 LC 1x 1/2"x250,0 	
		<ul style="list-style-type: none"> 8794 C 1x 1/2"x52,0 	
		<ul style="list-style-type: none"> 8784 C2 1x 9/16"x1/2"x50,0 	
		<ul style="list-style-type: none"> 851/2 Z PH 1x PH 2x32; 1x PH 3x32 	
		<ul style="list-style-type: none"> 867/2 Z TORX® 1x TX 20x35; 1x TX 25x35; 1x TX 27x35; 1x TX 30x35; 1x TX 40x35; 1x TX 45x35; 1x TX 50x35; 1x TX 55x35 	
		<ul style="list-style-type: none"> 840/2 Z 1x 5x30; 1x 6x30; 1x 8x30; 1x 10x30 	

8100 SC 10 Zyklop Metal 推杆换向棘轮扳手组套 · 1/2" 驱动 · 英制



Code	EAN				
05004080001	4013288 173966				1
		□	8003 C 1x 1/2"x281,0		
		●	8790 HMC 1x 3/8"x37,0; 1x 7/16"x37,0; 1x 1/2"x37,0; 1x 9/16"x37,0; 1x 19/32"x37,0; 1x 5/8"x37,0; 1x 11/16"x37,0; 1x 3/4"x37,0; 1x 25/32"x37,0; 1x 13/16"x37,0		
		■	8794 LC 1x 1/2"x250,0		
		■	8794 C 1x 1/2"x52,0		
		●	8784 C2 1x 5/16"x1/2"x50,0		
		+	851/2 Z PH 1x PH 2x32; 1x PH 3x32		
		+	867/2 Z TORX® 1x TX 20x35; 1x TX 25x35; 1x TX 27x35; 1x TX 30x35; 1x TX 40x35; 1x TX 45x35; 1x TX 50x35; 1x TX 55x35		
		○	840/2 Z 1x 7/32"x30; 1x 1/4"x30; 1x 5/16"x30; 1x 3/8"x30		

8003 C Zyklop Metal 推杆换向棘轮扳手 · 1/2" 驱动

- 带换向拨杆，扁长设计。较长杠杆。通体铬钼钢锻造。
- Zyklop Metal 推杆式：双齿结构使其坚固的38齿也能得到和76细齿一样的4.7°回转角。
- 非拆卸式的推杆头可平滑转换
- 用于1/2"内四方，带球锁

8003 C Zyklop Metal 推杆换向棘轮扳手 · 1/2" 驱动



Code	EAN	□	mm	mm	mm	
05004063001	4013288 174055	1/2"	281,0	36	37	3

Zyklop Metal 拨杆式棘轮扳手



球锁可安全锁定套筒及其他配件
拨杆式可方便换向
纤细设计
具有小至5°的回转角
扁长设计增强杠杆应用
通体铬钼钢锻造

- 棘轮扳手极为纤细、省力
- 小至4.7°的回转角
- 非拆卸式的推杆头可平滑转换
- “易寻”色标系统
- 拨杆便于换向
- 棘轮扳手极为纤细、省力
- 小至5°的回转角

8100 SC 8 Zyklop Metal 拨杆换向棘轮扳手组套 · 1/2" 驱动 · 公制



Code	EAN				
05004078001	4013288 173881				1
		□	8004 C 1x 1/2"x281,0		
		●	8790 HMC 1x 10,0x37,0; 1x 11,0x37,0; 1x 12,0x37,0; 1x 13,0x37,0; 1x 14,0x37,0; 1x 15,0x37,0; 1x 16,0x37,0; 1x 17,0x37,0; 1x 18,0x37,0; 1x 19,0x37,0		
		■	8794 LC 1x 1/2"x250,0		
		■	8794 C 1x 1/2"x52,0		
		●	8784 C2 1x 5/16"x1/2"x50,0		
		+	851/2 Z PH 1x PH 2x32; 1x PH 3x32		
		+	867/2 Z TORX® 1x TX 20x35; 1x TX 25x35; 1x TX 27x35; 1x TX 30x35; 1x TX 40x35; 1x TX 45x35; 1x TX 50x35; 1x TX 55x35		
		○	840/2 Z 1x 5x30; 1x 6x30; 1x 8x30; 1x 10x30		

8100 SC 11 Zyklop Metal 拨杆换向棘轮扳手组套 · 1/2" 驱动 · 英制



Code	EAN			
05004081001	173973			1
		8004 C	1x 1/2"x281,0	
		8790 HMC	1x 3/8"x37,0; 1x 7/16"x37,0; 1x 1/2"x37,0; 1x 9/16"x37,0; 1x 19/32"x37,0; 1x 5/8"x37,0; 1x 11/16"x37,0; 1x 3/4"x37,0; 1x 25/32"x37,0; 1x 13/16"x37,0	
		8794 LC	1x 1/2"x250,0	
		8794 C	1x 1/2"x52,0	
		8784 C2	1x 5/16"x1/2"x50,0	
		851/2 Z PH	1x PH 2x32; 1x PH 3x32	
		867/2 Z TORX®	1x TX 20x35; 1x TX 25x35; 1x TX 27x35; 1x TX 30x35; 1x TX 40x35; 1x TX 45x35; 1x TX 50x35; 1x TX 55x35	
		840/2 Z	1x 7/32"x30; 1x 1/4"x30; 1x 5/16"x30; 1x 3/8"x30	

8004 C Zyklop Metal 拨杆换向棘轮扳手 · 1/2" 驱动

- 拨杆便于换向
- 棘轮扳手极为纤细、省力
- 小至5°的回转角
- 套筒锁定装置

8004 C Zyklop Metal 拨杆换向棘轮扳手 · 1/2" 驱动



Code	EAN					
05004064001	174062	1/2"	281,0	34	37	3

8790 C Impaktor 套筒 · 1/2" 驱动

Impaktor套筒配合带12.5mm = 1/2"英寸驱动的电动或气动冲击型工具使用。

Impaktor技术可确保在极端条件下也能增加工具的平均使用寿命。带“易寻”色标系统,可轻松找到所需套筒。带六角型面和槽口的套筒。

与双六角形批头相比,此六角形批头允许强大的传输力量及减少螺栓边缘或螺丝头的形变。

用于六角头螺栓、螺钉和螺帽。

- 配合带12.5mm = 1/2"驱动的电动或气动冲击型工具使用。
- Impaktor技术,使用寿命高于平均水平
- 采用六角型面,可更有效的实现高力矩传输的精确紧固操作,同时可保护工具表面。
- 带“易寻”色标系统,可轻松找到所需套筒
- 带十字孔和环状扣环,可固定套筒的固定销和0环

8790 C Impaktor 套筒 · 1/2" 驱动



Code	EAN						
05004570001	210012		13,0	38,0	21,0	24,0	1
05004571001	210029		14,0	38,0	22,0	24,0	1
05004572001	210036		15,0	38,0	24,0	24,0	1
05004573001	210043		16,0	38,0	24,0	24,0	1
05004574001	210050		17,0	38,0	26,0	26,0	1
05004575001	210067		18,0	38,0	28,0	28,0	1
05004576001	210074		19,0	38,0	28,0	28,0	1
05004577001	210081		20,0	38,0	26,0	30,0	1
05004578001	210098		21,0	38,0	26,0	30,0	1

工具带C Impaktor 1套筒组件 · 1/2"驱动

坚固耐用的织物工具带，采用典型的Wera设计，附有9个Impaktor套筒，可用于狭小空间内的操作。顺畅的旋转扣机构，可安全存放和轻松移除套筒。

随附用于连接到腰带或工具袋的吊钩。采用纤维网底面以及弯钩和环扣带，安装方便，例如可安装在墙壁、置物架、车间工具车以及Wera 2go工具携带系列。

Impaktor套筒配合带12.5mm = 1/2"驱动的电动或气动冲击型工具使用。Impaktor技术可确保在极端条件下也能增加工具的平均使用寿命。

带“易寻”色标系统，可轻松找到所需套筒。六角花形套筒。与双六角形批头相比，此六角形批头允许强大的传输力量及减少螺栓边缘或螺丝头的形变。

用于六角螺栓和螺帽。

- 9件套筒组件，采用牢固耐用的织物工具带，1/2"
- 平滑的拧开解锁设计使得套筒的保存更安全，使用更方便
- 特别适用于冲击螺丝刀
- 带“易寻”色标系统，可轻松找到所需套筒
- 可附着到墙壁、架子、工具车和维拉2go系列产品上

套筒磁性条带 C Impaktor 1 套筒组套 · 1/2" 驱动

套筒条带，含 9 件 Impaktor 套筒扳手，适合采用电动或气动扳手的应用，12.5 mm = 1/2" 驱动。

Impaktor抗冲击技术即使在极端条件下的使用寿命依旧高于平均水平。六角端头可传递较高扭矩，同时确保精密作业，保护端头。

含“易寻”色标系统用特定颜色代表不同刀头花形和尺寸，有助于轻松快速查找所需工具。条带可暂时吸附到金属表面，含拧转解锁设计，确保安全固定收纳套筒套筒。

- 9 件套筒组件含套筒条带，1/2"
- 配合带12.5mm = 1/2"驱动的电动或气动冲击型工具使用
- Impaktor技术，使用寿命高于平均水平
- 采用六角型面，可传输高力矩并更精确旋紧操作，同时可保护花形
- 带十字孔和环状扣环，可固定套筒的固定销和O环



工具带C Impaktor 1套筒组件 · 1/2"驱动

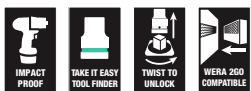

Code	EAN		
05004580001	210104		1
		● 8790 C Impaktor 1x 13,0x38,0; 1x 14,0x38,0; 1x 15,0x38,0; 1x 16,0x38,0; 1x 17,0x38,0; 1x 18,0x38,0; 1x 19,0x38,0; 1x 20,0x38,0; 1x 21,0x38,0	
		Belt C Impaktor 0/9 1x 71,0x210,0	
		魔术贴 30 1x 30,0x200,0	

套筒磁性条带 C Impaktor 1 套筒组套 · 1/2" 驱动



Code	EAN		
05005490001	223289		1
		● 8790 C Impaktor 1x 13,0x38,0; 1x 14,0x38,0; 1x 15,0x38,0; 1x 16,0x38,0; 1x 17,0x38,0; 1x 18,0x38,0; 1x 19,0x38,0; 1x 20,0x38,0; 1x 21,0x38,0	
		9602 1x 30,0x370,0	

8790 C Impaktor Deep 套筒 · 1/2" 驱动

Impaktor抗冲击长型套筒, 适合采用电动或气动扳手的应
用, 12.5 mm = 1/2" 驱动。用于难以触及的工件和长螺杆。

Impaktor抗冲击技术即使在极端条件下的使用寿命依旧
高于平均水平。

含“易寻”色标系统用特定颜色代表不同刀头花形, 有助
于轻松快速查找所需工具。

六角花形和内壁。六角花形和内壁。六角端头可实现高
力度传递, 螺栓或螺丝边缘的负荷比双六角花形小。

用于外六角螺栓和螺丝。

- 经久耐用的 Impaktor 套筒可在极高应力条件下使用, 适合
采用电动或气动扳手的应用, 12.5 mm = 1/2" 驱动
- 长型套筒扳手可用于难以触及的工件, 适合在密闭空间
内装配长螺杆
- 带十字孔和环状扣环, 可固定套筒的固定销和O环

8790 C Impaktor Deep 套筒 · 1/2" 驱动



Code	EAN		mm	mm	mm	mm	
05004830001	221926		13,0	83,0	21,0	24,0	1
05004831001	221933		14,0	83,0	22,0	24,0	1
05004832001	221940		15,0	83,0	24,0	24,0	1
05004833001	221957		16,0	83,0	24,0	24,0	1
05004834001	221964		17,0	83,0	26,0	26,0	1
05004835001	221995		18,0	83,0	28,0	28,0	1
05004836001	222008		19,0	83,0	28,0	28,0	1
05004837001	222015		21,0	83,0	30,0	27,0	1
05004838001	222107		22,0	83,0	32,0	28,0	1
05004839001	222114		24,0	83,0	34,0	30,0	1
05004840001	222121		27,0	83,0	38,0	33,0	1

8790 C Impaktor Deep 组套 1

组套, 含 11 件 Impaktor Deep 套筒, 适合采用电动或气动
扳手的应用, 12.5 mm = 1/2" 驱动。

延长杆设计用于难以触及的接头和长螺杆。

Impaktor 技术即使在极端条件下的使用寿命依旧高于平
均水平。

六角端头可传递较高扭矩, 同时确保精密作业, 保护端
头。

“易寻”色标系统, 按尺寸进行颜色编码, 可快速方便地找
到所需工具。

- 加长型1/2"手动和机械(非抗冲击型)套筒, 用于紧凑结构
空间内的低挡位的螺纹配合连接, 以及凸头螺杆
- 配合带12.5mm = 1/2"驱动的电动或气动冲击型工具使用
- Impaktor技术, 使用寿命高于平均水平
- 采用六角型面, 可传输高力矩并更精确旋紧操作, 同时可
保护花形
- 带十字孔和环状扣环, 可固定套筒的固定销和O环
- 带“易寻”色标系统, 可轻松找到所需套筒
- 采用经久耐用的织物收纳用腰包

8790 C Impaktor Deep 组套 1

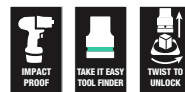

Code	EAN		
05004841001	224088		1
		<p>● 8790 C Impaktor Deep 1x 13,0x83,0; 1x 14,0x83,0; 1x 15,0x83,0; 1x 16,0x83,0; 1x 17,0x83,0; 1x 18,0x83,0; 1x 19,0x83,0; 1x 21,0x83,0; 1x 22,0x83,0; 1x 24,0x83,0; 1x 27,0x83,0</p>	

8790 HMC Zyklop 套筒 · 1/2" 驱动

- 1/2" Zyklop套筒
- 用于手动和非冲击电动工具
- 尾部滚花以便于手指握持操作
- 带球锁
- “易寻”色标系统: 用特定的颜色代表不同端头种类和尺寸

8790 HMC Zyklop 套筒 · 1/2" 驱动



Code	EAN		mm	mm	mm	mm	mm	
05003601001	120618		10,0	37,0	15,5	24,0	1	
05003602001	120625		11,0	37,0	16,5	24,0	1	
05003603001	120656		12,0	37,0	17,5	24,0	1	
05003604001	120663		13,0	37,0	19,0	24,0	1	
05003605001	120670		14,0	37,0	20,0	24,0	1	
05003606001	120687		15,0	37,0	21,0	24,0	1	
05003607001	120694		16,0	37,0	22,5	24,0	1	
05003608001	120700		17,0	37,0	24,0	26,0	1	
05003609001	120717		18,0	37,0	25,0	26,0	1	
05003610001	120724		19,0	37,0	26,5	26,0	1	
05003611001	120731		20,0	37,0	28,0	26,0	1	
05003612001	120748		21,0	37,0	29,0	26,0	1	
05003613001	120755		22,0	37,0	30,5	26,0	1	
05003614001	120762		24,0	37,0	33,0	28,0	1	
05003615001	120779		27,0	40,0	36,5	32,0	1	
05003616001	120786		30,0	42,0	40,0	34,0	1	
05003617001	120793		32,0	42,0	42,0	36,0	1	
05003618001	120809			37,0	15,5	24,0	1	3/8"
05003619001	120816			37,0	16,5	24,0	1	7/16"
05003620001	120823			37,0	19,0	24,0	1	1/2"
05003621001	120830			37,0	20,0	24,0	1	9/16"
05003622001	120847			37,0	21,0	24,0	1	19/32"
05003623001	120854			37,0	22,5	24,0	1	5/8"
05003624001	120861			37,0	25,5	26,0	1	11/16"
05003625001	120878			37,0	26,5	26,0	1	3/4"
05003626001	120885			37,0	28,0	26,0	1	25/32"
05003627001	120892			37,0	29,0	26,0	1	13/16"
05003628001	120908			37,0	30,5	26,0	1	7/8"
05003629001	120915			37,0	33,0	28,0	1	15/16"
05003630001	120922			37,0	33,0	28,0	1	31/32"
05003631001	120939			40,0	36,5	32,0	1	1"
05003632001	120946			40,0	36,5	32,0	1	1 1/16"
05003633001	120953			40,0	40,0	34,0	1	1 1/8"
05003634001	120960			42,0	40,0	34,0	1	1 3/16"
05003635001	120977			42,0	42,0	36,0	1	1 1/4"

8790 HMC HF Zyklop 套筒 · 1/2" 驱动 · 带固持功能

- (非冲击) 套筒, 用于机动和电动工具
- 固持功能确保螺丝牢固黏着在工具上
- “易寻”色标系统: 用特定的颜色代表不同端头种类和尺寸
- 高品质铬钒钢, 亚光镀铬
- 带球锁, 尾部滚花以便于手指握持

8790 HMC HF Zyklop 套筒 · 1/2" 驱动 · 带固持功能



Code	EAN		mm	mm	mm	mm	mm	
05003730001	180957		10,0	37,0	17,8	23,5	10,4	1
05003731001	180964		11,0	37,0	18,8	23,5	10,4	1
05003732001	180971		12,0	37,0	20,4	23,5	11,4	1
05003733001	181022		13,0	37,0	21,4	23,5	11,4	1
05003734001	181039		14,0	37,0	22,6	23,5	11,4	1
05003735001	181046		15,0	37,0	23,6	23,5	12,0	1
05003736001	181053		16,0	37,0	25,0	23,5	12,0	1
05003737001	181060		17,0	37,0	26,8	23,5	12,5	1
05003738001	181077		18,0	37,0	28,0	23,5	12,5	1
05003739001	181084		19,0	37,0	29,2	23,5	14,0	1

套筒条带 C 1 Zyklop 套筒组套 · 带固持功能 · 1/2" 驱动

采用维拉的典型设计，牢固的织物条带内装有6个旋具套筒，非常节省空间。

平滑的拧开解锁设计使得套筒的保存更安全，使用更方便。带“易寻”色标系统，可轻松快速地根据尺寸找到所需套筒。

带弹簧扣，可以牢固地扣在皮带环或口袋上。带固持功能，操作方便，并可防止作业中在接近工件时丢失螺丝。

可通过反面的魔术贴将条带附着到墙壁、架子、工具车和维拉2go系列产品上。

- 牢固的织物条带，内含7个1/2"驱动的套筒
- 操作螺丝、螺栓和螺母时带固持功能
- 平滑的拧开解锁设计使得套筒的保存更安全，使用更方便
- “易寻”色标系统：用特定的颜色代表不同端头种类和尺寸
- 可附着到墙壁、架子、工具车和维拉2go系列产品上

套筒条带 C 1 Zyklop 套筒组套 · 带固持功能 · 1/2" 驱动



Code	EAN		
05003995001	204400		1
		● 8790 HMC HF 1x 10,0x37,0; 1x 13,0x37,0; 1x 15,0x37,0; 1x 16,0x37,0; 1x 17,0x37,0; 1x 19,0x37,0	
		螺帽取出器 1x 14,0x43,0	
		Belt C 0/6 1x 45,0x275,0	
		魔术贴 30 1x 30,0x200,0	

套筒磁性条带 C Imperial 1 Zyklop 套筒组套 · 1/2" 驱动 · 英制

套筒条带，含9件手动和机器操作的套筒（非冲击），1/2"。拧转解锁设计，用于安全收纳并轻松取放套筒。

含“易寻”色标系统用特定颜色代表不同刀头花形和尺寸，有助于轻松快速查找所需工具。

条带可暂时吸附到金属表面，含拧转解锁设计，确保安全固定收纳套筒套筒。

- 9件套筒组件含套筒条带，1/2"
- 条带含便于取用的套筒旋转扣支座，用于暂时安装到墙壁、柜子、车间用滚轮小车
- 平滑的拧开解锁设计使得套筒的保存更安全，使用更方便
- 带“易寻”色标系统，可轻松找到所需套筒

套筒磁性条带 C Imperial 1 Zyklop 套筒组套 · 1/2" 驱动 · 英制



Code	EAN		
05005480001	223296		1
		● 8790 HMC 1x 3/8"x37,0; 1x 7/16"x37,0; 1x 1/2"x37,0; 1x 9/16"x37,0; 1x 5/8"x37,0; 1x 11/16"x37,0; 1x 3/4"x37,0; 1x 7/8"x37,0; 1x 1"x40,0	
		9602 1x 30,0x370,0	

8790 HMC HF 1 Zyklop 筒组套 · 带固持功能

10件套, 带表面防护的紧凑而坚固的织布包装, 体积小、重量轻, 便于携带。

10个1/2"驱动的Zyklop套筒, 带固持功能“Take it easy”工具易寻色标: 用特定的颜色代表不同花形, 再辅以简洁的尺寸标示, 让寻找工具变得简单快速。

- 紧凑而极为坚固的织布盒包装, 体积小而轻便
- 旋具套筒 (非冲击), 用于手动和电动工具
- 固持功能确保螺丝牢固黏着在工具上
- “易寻”色标系统: 用特定的颜色代表不同端头种类和尺寸
- 套筒尾部滚花以便于手指握持操作

8790 HMC HF 1 Zyklop 筒组套 · 带固持功能



Code	EAN			
05004203001	184238			1
		8790 HMC HF 1x 10,0x37,0; 1x 11,0x37,0; 1x 12,0x37,0; 1x 13,0x37,0; 1x 14,0x37,0; 1x 15,0x37,0; 1x 16,0x37,0; 1x 17,0x37,0; 1x 18,0x37,0; 1x 19,0x37,0		
		魔术贴 120 1x 50,0x120,0		

8790 C Wheel Impaktor 套筒 · 1/2" 驱动

Impaktor套筒、1/2", 配合使用冲击型工具, 带旋转顺滑型塑料衬套, 旋紧时的操作速度更快, 精度更高, 以及更良好的保护轮边。

- 配合带12.5mm = 1/2"驱动的电动或气动冲击型工具使用
- 坚固耐用的Impaktor设计, 可在极高受力条件下使用
- 采用六角型面, 可更有效的实现高力矩传输的精确紧固操作, 同时可保护工具表面。
- “易寻”色标系统: 用特定的颜色代表不同端头种类和尺寸

8790 C Wheel Impaktor 套筒 · 1/2" 驱动



Code	EAN							
05004590001	210739		17,0	85,0	30,0			1
05004591001	210746		19,0	85,0	30,0			1
05004592001	210753		21,0	85,0	32,0			1

Wheel Impaktor C 1 套筒组件 · 1/2" 驱动

3个1/2英寸Impaktor套筒扳手插件、配合使用冲击型扳手,带旋转顺滑型塑料衬套,旋拧操作时的操作速度更快,提供更好的轮缘保护。• 内部塑料插件用于保护轮式螺栓表面。

Wheel Impaktor C 1 套筒组件 · 1/2"驱动



Code		EAN		
05004595001		210760	4013288	1
		●	8790 C Wheel Impaktor 1x 17,0x85,0x30,0; 1x 19,0x85,0x30,0; 1x 21,0x85,0x32,0	

8790 HMC Deep 套筒 · 1/2" 加长型套筒

加长型 1/2"手动和机械用套筒 (ISO 2725 第3部分) 内藏卡位球锁; 用于外六角螺栓和套筒。

用于手动和机器操作 (非敲击型), 可应用于低位紧固和凸头螺纹杆。带 „易寻“ 色标系统, 可轻松找到所需套筒。即便是手上有油, 也能轻松握持。

与双六角形批头相比, 此六角形批头允许强大的传输力量及减少螺栓边缘或螺丝头的形变。

尽管在有限空间内, 由于它的小后回转角度, 细齿棘轮让双六角形变得多余。

- 长型扳手用于低位旋紧, 甚至可以应用在狭小空间的凸头螺纹杆上。
- 采用六角型面, 可实现高力矩传输的精确螺栓紧固操作, 同时对螺丝帽凹槽部分提供了更良好的保护
- 尾部滚花以便于手指握持操作
- 采用亚光镀铬的铬钒合金材质

8790 HMC Deep 套筒 · 1/2" 加长型套筒



Code	EAN	mm	mm	mm	mm	
05004550001	210562	10,0	83,0	15,5	21,8	1
05004551001	210579	11,0	83,0	16,7	22,0	1
05004552001	210586	12,0	83,0	18,0	22,0	1
05004553001	210593	13,0	83,0	19,2	22,0	1
05004554001	210609	14,0	83,0	20,5	22,0	1
05004555001	210616	15,0	83,0	22,0	20,7	1
05004556001	210623	16,0	83,0	22,0	20,7	1
05004557001	210630	17,0	83,0	24,0	22,2	1
05004558001	210647	18,0	83,0	26,0	23,2	1
05004559001	210654	19,0	83,0	26,0	23,2	1
05004560001	210661	20,0	83,0	28,0	25,2	1
05004561001	210678	21,0	83,0	28,0	25,2	1
05004562001	210685	22,0	83,0	30,0	27,2	1
05004563001	210692	24,0	83,0	32,0	28,2	1

套筒条带 C Deep 1 套筒组套 · 1/2" 驱动

- 6件套筒组件, 采用牢固耐用的织物工具带, 1/2"
- 平滑的拧开解锁设计使得套筒的保存更安全, 使用更方便
- 加长型 1/2" 手动和机械 (非抗冲击型) 套筒, 用于紧凑结构空间内的低挡位的螺纹配合连接, 以及凸头螺纹杆
- 采用六角型面, 可更有效的实现高力矩传输的精确紧固操作, 同时可保护工具表面。
- “易寻”色标系统: 用特定的颜色代表不同端头种类和尺寸

套筒条带 C Deep 1 套筒组套 · 1/2" 驱动



Code		EAN					
05004565001		210708					1
			●	8790 HMC Deep			
				1x 10,0x83,0; 1x 13,0x83,0; 1x 15,0x83,0;			
				1x 16,0x83,0; 1x 17,0x83,0; 1x 19,0x83,0			
				Belt C 0/6			
				1x 45,0x275,0			
				魔术贴 30			
				1x 30,0x200,0			

套筒磁性条带 C Deep 1 套筒组套 · 1/2" 驱动

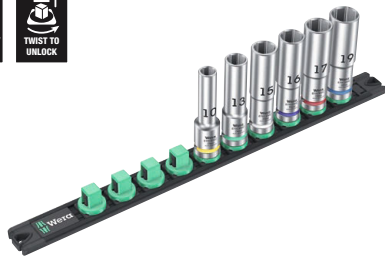

Code		EAN					
05005470001		223272					1
			●	8790 HMC Deep			
				1x 10,0x83,0; 1x 13,0x83,0; 1x 15,0x83,0;			
				1x 16,0x83,0; 1x 17,0x83,0; 1x 19,0x83,0			
				9602			
				1x 30,0x370,0			

8790 HMC Deep 套筒扳手嵌件 · 带切口轴 · 1/2" 驱动

外六角螺栓和螺丝套筒, 1/2", 长款设计侧面开槽, 用于安装面板连接器。带球锁。适用于手动和机械操作的工具 (无冲击)。

- 侧面开槽, 用于安装顶部和侧面接线的的面板连接器

8790 HMC Deep 套筒扳手嵌件 · 带切口轴 · 1/2" 驱动



	EAN	Hex	Socket	Socket	Socket	Socket	Socket	Socket
Code	4013288	mm	mm	mm	mm	mm	mm	
05138007001	233547	17,0	76,0	24,0	24,0	10,0		1

8767 C HF TORX® 梅花 Zyklop 旋具套筒 · 1/2" 驱动 · 带固持功能

- 旋具套筒 (非冲击), 用于手动和机动工具
- 固持功能确保螺丝牢固黏着在工具上
- “易寻”色标系统: 用特定的颜色代表不同端头种类和尺寸
- 尾部滚花以便于手指握持操作
- 高品质铬钒钢, 亚光镀铬

8767 C HF TORX® 梅花 Zyklop 旋具套筒 · 1/2" 驱动 · 带固持功能

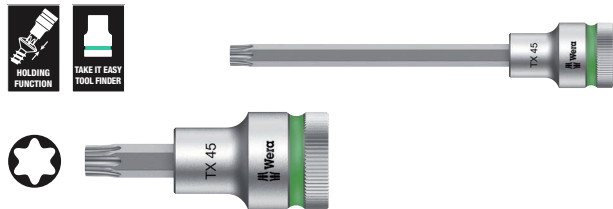

Code	EAN			mm	mm	mm	mm	
05003830001	183316		TX 20	60,0	16,4	23,5	21,5	1
05003850001	183545		TX 20	140,0	16,4	23,5	101,5	1
05003831001	183323		TX 25	60,0	16,4	23,5	21,5	1
05003851001	183552		TX 25	140,0	16,4	23,5	101,5	1
05003832001	183330		TX 27	60,0	16,4	23,5	21,5	1
05003852001	183569		TX 27	140,0	16,4	23,5	101,5	1
05003833001	183347		TX 30	60,0	16,4	23,5	21,5	1
05003853001	183576		TX 30	140,0	16,4	23,5	101,5	1
05003834001	183354		TX 40	60,0	16,4	23,5	21,5	1
05003854001	183583		TX 40	140,0	16,4	23,5	101,5	1
05003835001	183361		TX 45	60,0	16,4	23,5	21,5	1
05003855001	184443		TX 45	140,0	16,4	23,5	101,5	1
05003836001	183378		TX 50	60,0	21,4	23,5	21,5	1
05003856001	183606		TX 50	140,0	21,4	23,5	101,5	1
05003837001	183385		TX 55	60,0	21,4	23,5	21,5	1
05003857001	183613		TX 55	140,0	21,4	23,5	101,5	1
05003838001	183392		TX 60	60,0	21,4	23,5	21,5	1
05003858001	183620		TX 60	140,0	21,4	23,5	101,5	1

套筒条带 C 3 TORX® HF Zyklop HF Zyklop 旋具套筒组套 · 带固持功能 · 1/2" 驱动

采用维拉的典型设计, 牢固的织物条带内装有6个内六角旋具套筒, 非常节省空间。

平滑的拧开解锁设计使得套筒的保存更安全, 使用更方便。带“易寻”色标系统, 可轻松快速地根据尺寸找到所需套筒。带弹簧扣, 可以牢固地扣在皮带环或口袋上。

可通过反面的魔术贴将条带附着到墙壁、架子、工具车和维拉2go系列产品上。

- 6件套筒组件, 采用牢固耐用的织物工具带, 1/2"
- 拥有维拉批头技术的所有优点
- 操作螺丝、螺栓时带固持功能
- 平滑的拧开解锁设计使得套筒的保存更安全, 使用更方便
- 可附着到墙壁、架子、工具车和维拉2go系列产品上

套筒条带 C 3 TORX® HF Zyklop HF Zyklop 旋具套筒组套 · 带固持功能 · 1/2" 驱动



Code	EAN		
05003997001	204882		1
		8767 C HF 1x TX 25x60,0; 1x TX 30x60,0; 1x TX 40x60,0; 1x TX 45x60,0; 1x TX 50x60,0; 1x TX 55x60,0	
		Belt C 0/6 1x 45,0x275,0	
		魔术贴 30 1x 30,0x200,0	

套筒磁性条带 C 4 Zyklop 套筒组套 · 1/2" 驱动
 套筒条带, 含9件手动和机器操作的套筒 (非冲击), 1/2"。
 拧转解锁设计, 用于安全收纳并轻松取放套筒。

含“易寻”色标系统用特定颜色代表不同刀头花形和尺寸, 有助于轻松快速查找所需工具。

条带可暂时吸附到金属表面, 含拧转解锁设计, 确保安全固定收纳套筒套筒。

- 9 件套筒组件含套筒条带, 1/2"
- 条带含便于取用的套筒旋转扣支座, 用于暂时安装到墙壁、柜子、车间用滚轮小车
- 平滑的拧开解锁设计使得套筒的保存更安全, 使用更方便
- 带“易寻”色标系统, 可轻松找到所需套筒

套筒磁性条带 C 4 Zyklop 套筒组套 · 1/2" 驱动

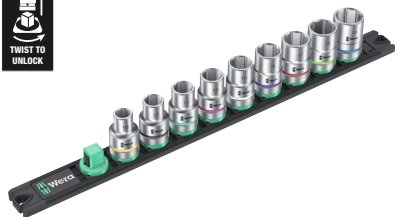

Code	EAN		
05005460001	223265		1
		● 8790 HMC 1x 10,0x37,0; 1x 12,0x37,0; 1x 13,0x37,0; 1x 14,0x37,0; 1x 15,0x37,0; 1x 16,0x37,0; 1x 17,0x37,0; 1x 18,0x37,0; 1x 19,0x37,0	
		9602 1x 30,0x370,0	

8767 C TORX® 梅花 HF 1 Zyklop 旋具套筒组套 · 1/2" 驱动 · 带固持功能

- 紧凑而极为坚固的织物盒包装, 体积小而轻便

8767 C TORX® 梅花 HF 1 Zyklop 旋具套筒组套 · 1/2" 驱动 · 带固持功能



Code	EAN		
05004202001	184276		1
		♻️ 8767 C HF 1x TX 20x60,0; 1x TX 25x60,0; 1x TX 27x60,0; 1x TX 30x60,0; 1x TX 40x60,0; 1x TX 45x60,0; 1x TX 50x60,0; 1x TX 55x60,0; 1x TX 60x60,0	

8767 C TORX® 梅花 HF 2 Zyklop 套筒组套 · 1/2" 驱动 · 带固持功能

- 紧凑而极为坚固的织物盒包装, 体积小而轻便
- 长款

8767 C TORX® 梅花 HF 2 Zyklop 套筒组套 · 1/2" 驱动 · 带固持功能



Code	EAN		
05004211001	185464		1
		♻️ 8767 C HF 1x TX 20x140,0; 1x TX 25x140,0; 1x TX 27x140,0; 1x TX 30x140,0; 1x TX 40x140,0; 1x TX 45x140,0	
		魔术贴 120 1x 50,0x120,0	

8767 C TORX® 梅花 HF 3 Zyklop 旋具套筒组套 · 1/2" 驱动 · 带固持功能

- 紧凑而极为坚固的织物盒包装, 体积小而轻便
- 长款

8767 C TORX® 梅花 HF 3 Zyklop 旋具套筒组套 · 1/2" 驱动 · 带固持功能



Code	EAN		
05004212001	185471		1
		8767 C HF 1x TX 20x140,0; 1x TX 25x140,0; 1x TX 27x140,0; 1x TX 30x140,0; 1x TX 40x140,0; 1x TX 45x140,0; 1x TX 50x140,0; 1x TX 55x140,0; 1x TX 60x140,0	
		魔术贴 120 1x 50,0x120,0	

8740 C HF 旋具套筒 · 1/2" 驱动 · 带固持功能

- 旋具套筒 (非冲击), 用于手动和机动工具
- 固持功能确保螺丝牢固黏着在工具上
- “易寻”色标系统: 用特定的颜色代表不同端头种类和尺寸
- 尾部滚花以便于手指握持操作
- 高品质铬钒钢, 亚光镀铬

8740 C HF 旋具套筒 · 1/2" 驱动 · 带固持功能



Code	EAN							
Code	4013288	mm	mm	mm	mm	mm	mm	
05003820001	183217	4,0	60,0	14,0	21,5	21,5	1	
05003840001	183484	4,0	140,0	14,0	21,5	101,5	1	
05003821001	183224	5,0	60,0	14,0	21,5	21,5	1	
05003841001	183491	5,0	140,0	14,0	21,5	101,5	1	
05003822001	183231	6,0	60,0	14,0	21,5	21,5	1	
05003842001	183507	6,0	140,0	14,0	21,5	101,5	1	
05003823001	183248	7,0	60,0	14,0	23,5	21,5	1	
05003843001	183514	7,0	140,0	14,0	23,5	101,5	1	
05003824001	183255	8,0	60,0	16,0	23,5	21,5	1	
05003844001	183521	8,0	140,0	16,0	23,5	101,5	1	
05003825001	183262	10,0	60,0	16,0	23,5	21,5	1	
05003845001	183538	10,0	140,0	16,0	23,5	101,5	1	
05003826001	183279	12,0	60,0	21,0	23,5	23,0	1	
05003827001	183286	14,0	60,0	22,0	23,5	23,0	1	
05003828001	183293	17,0	60,0	24,5	25,5	23,0	1	
05003829001	183309	19,0	60,0	26,5	27,5	23,0	1	

套筒条带 C 2 Zyklop 增强型内六角旋具套筒组套 · 带固持功能 · 1/2" 驱动

采用维拉的典型设计, 牢固的织物条带内装有6个内六角旋具套筒, 非常节省空间。

平滑的拧开解锁设计使得套筒的保存更安全, 使用更方便。带“易寻”色标系统, 可轻松快速地根据尺寸找到所需套筒。带弹簧扣, 可以牢固地扣在皮带环或口袋上。

可通过反面的魔术贴将条带附着到墙壁、架子、工具车和维拉2go系列产品上。

- 6件套筒组件, 采用牢固耐用的织物工具带, 1/2"
- 拥有维拉批头技术的所有优点
- 操作螺丝、螺栓时带固持功能
- 平滑的拧开解锁设计使得套筒的保存更安全, 使用更方便
- 可附着到墙壁、架子、工具车和维拉2go系列产品上

套筒条带 C 2 Zyklop 增强型内六角旋具套筒组套 · 带固持功能 · 1/2" 驱动



	Code	EAN		
	05003996001	4013288 204424		1
			8740 C HF 1x 4,0x60,0; 1x 5,0x60,0; 1x 6,0x60,0; 1x 7,0x60,0; 1x 8,0x60,0; 1x 10,0x60,0	
			Belt C 0/6 1x 45,0x275,0	
			魔术贴 30 1x 30,0x200,0	

8740 C HF 1 Zyklop 旋具套筒组套 · 1/2" 驱动 · 带固持功能

- 紧凑而极为坚固的织物盒包装, 体积小而轻便

8740 C HF 1 Zyklop 旋具套筒组套 · 1/2" 驱动 · 带固持功能



	Code	EAN		
	05004201001	4013288 184283		1
			8740 C HF 1x 4,0x60,0; 1x 5,0x60,0; 1x 6,0x60,0; 1x 7,0x60,0; 1x 8,0x60,0; 1x 10,0x60,0; 1x 12,0x60,0; 1x 14,0x60,0; 1x 17,0x60,0	
			魔术贴 120 1x 50,0x120,0	

8740 C HF 2 Zyklop 套筒组套 · 1/2" 驱动 · 带固持功能

- 紧凑而极为坚固的织物盒包装, 体积小而轻便
- 长款

8740 C HF 2 Zyklop 套筒组套 · 1/2" 驱动 · 带固持功能



	Code	EAN		
	05004210001	4013288 185457		1
			8740 C HF 1x 4,0x140,0; 1x 5,0x140,0; 1x 6,0x140,0; 1x 7,0x140,0; 1x 8,0x140,0; 1x 10,0x140,0	
			魔术贴 120 1x 50,0x120,0	

9529 C SB 散热器用5阶扳手 1/2"

- 5级 (3/8"、7/16"、1/2"、16 mm 和 21 mm)
- 对于 1/2" 棘轮
- 铬钒钢使得得插

9529 C SB 散热器用5阶扳手 1/2"

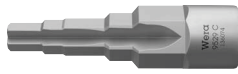

	EAN								
Code	4013288	mm							
05136074001	228390	88,0							1

8796 LC Zyklop 快速锁定延长杆，带自由旋转护套，长型，1/2"

- 用于 1/2" 内四方，带球锁
- 快速锁定装置即可锁定、也可快速更换套筒
- 带自由旋转护套，可快速紧固和松开螺丝螺母

8796 LC Zyklop 快速锁定延长杆，带自由旋转护套，长型，1/2"



	EAN								
Code	4013288	mm							
05003643001	121462	1/2"	250,0						1

8796 SC Zyklop 快速锁定延长杆，带自由旋转护套，短型，1/2"

- 用于 1/2" 内四方，带球锁
- 快速锁定装置即可锁定、也可快速更换套筒
- 带自由旋转护套，可快速紧固和松开螺丝螺母

8796 SC Zyklop 快速锁定延长杆，带自由旋转护套，短型，1/2"



	EAN								
Code	4013288	mm							
05003642001	121455	1/2"	125,0						1

8794 LC Zyklop 延长杆，带自由旋转护套，长型，1/2"

自由旋转护套可有效加速螺丝和螺帽的装卸过程。

8794 LC Zyklop 延长杆，带自由旋转护套，长型，1/2"



	EAN								
Code	4013288	mm							
05003638001	121431	1/2"	250,0						1

8794 SC Zyklop 延长杆 · 带自由旋转护套 · 短型 · 1/2"

1/2" Zyklop延长杆, 带自由旋转护套, 短型。带自由旋转护套, 可快速紧固和松开螺母。高品质铬钒钢, 亚光镀铬。

8794 SC Zyklop 延长杆 · 带自由旋转护套 · 短型 · 1/2"



Code	EAN	Icon	Length	Material	Weight	Quantity
05003637001	121424	1/2"	125,0			1

8789 C Zyklop T 型滑动手柄 · 1/2"

1/2" Zyklop T型滑动手柄, 带滑柄驱动。用于1/2"内四方, 带球锁。高品质铬钒钢, 亚光镀铬。

8789 C Zyklop T 型滑动手柄 · 1/2"



Code	EAN	Icon	Length	Material	Weight	Quantity
05003636001	121530	1/2"	250,0			3

8795 C Zyklop 万向接头 · 1/2"

1/2" Zyklop万向接头。用于1/2"内四方, 带球锁。高品质铬钒/铬钼钢, 亚光镀铬。

8795 C Zyklop 万向接头 · 1/2"



Code	EAN	Icon	Length	Material	Weight	Quantity
05003640001	121547	1/2"	69,0			1

8794 C Zyklop 摆动延长杆 · 1/2"

Zyklop摆动式延长杆可以在15°的范围内活动, 使得工具可在隐蔽或封闭的安装区域内快速而精确地工作。

8794 C Zyklop 摆动延长杆 · 1/2"



Code	EAN	Icon	Length	Material	Weight	Quantity
05003639001	121448	1/2"	52,0			1

8784 C2 Zyklop 批头用转接头 · 1/2", 5/16"

1/2" Zyklop转接头, 带快速接头, 可快速更换批头。用于5/16"六角驱动的批头(维拉驱动转换系列2)。

8784 C2 Zyklop 批头用转接头 · 1/2", 5/16"



Code	EAN	Icon	Length	Material	Weight	Quantity
05003641001	119353	5/16"	50,0			1

8009 Zyklop 随身袋组套 1

紧凑的 Zyklop 棘轮，带有插槽的批头库。1/4" 批头和 3/8" 套筒的磁性直接安装。

由于未锁定安装，工具发生了快速变更。由于头部可在 0°、15° 和 90° 位置锁定，因此工具可用作棘轮和棘轮螺丝刀。

72 齿细齿机构，5° 较小回转角。由于手柄中集成了 12 个批头，应用范围很广。

牢固的棘轮机构可以实现足够的扭矩。Zyklop 棘轮与 12 件螺丝刀组套的完美组合。

- 紧凑型 Zyklop 棘轮，带集成式批头库
- 磁性插座同时将 3/8" 棘轮变成 1/4" 批头安装架的棘轮螺丝刀
- 可自由转动的棘轮头，带 5 种预设的锁定位置
- 细齿可逆棘轮（72 齿），低回转角仅 5°
- 固定式和旋转式批头库，便于批头的拆卸和安全存放

8009 Zyklop 随身袋组套 1



Code	EAN		
05004280001	4013288 221834		1
		<input type="checkbox"/> 8009 1x 3/8"x1/4"x133,0	
		<input checked="" type="checkbox"/> 851/1 BTZ 1x PH 1x25; 1x PH 2x25	
		<input checked="" type="checkbox"/> 855/1 BTZ 1x PZ 1x25; 1x PZ 2x25	
		<input checked="" type="checkbox"/> 867/1 TORX® BTZ 1x TX 10x25; 1x TX 15x25; 1x TX 20x25; 1x TX 25x25	
		<input checked="" type="checkbox"/> 840/1 BTZ 1x 3,0x25; 1x 4,0x25; 1x 5,0x25; 1x 6,0x25	

8009 Zyklop 随身袋组套 Imperial 1



Code	EAN		
05004282001	4013288 221841		1
		<input type="checkbox"/> 8009 1x 3/8"x1/4"x133,0	
		<input checked="" type="checkbox"/> 851/1 BTZ 1x PH 1x25; 1x PH 2x25	
		<input checked="" type="checkbox"/> 867/1 TORX® BTZ 1x TX 10x25; 1x TX 15x25; 1x TX 20x25; 1x TX 25x25	
		<input checked="" type="checkbox"/> 840/1 Z 1x 1/8"x25; 1x 5/32"x25; 1x 3/16"x25; 1x 1/4"x25	
		<input type="checkbox"/> 868/1 Z 1x # 1x25; 1x # 2x25	

8009 Zyklop 随身袋组套 2

紧凑的 Zyklop 棘轮，带有插槽的批头库。1/4" 批头和 3/8" 套筒的磁性直接安装。由于未锁定安装，工具发生了快速变更。

由于头部可在 0°、15° 和 90° 位置锁定，因此工具可用作棘轮和棘轮螺丝刀。72 齿细齿机构，5° 较小回转角。由于手柄中集成了 12 个批头，应用范围很广。牢固的棘轮机构可以实现足够的扭矩。

Zyklop 棘轮与 12 件螺丝刀组套的完美组合。75 mm 长的通用支架可用于 1/4" 批头的扩展。

包括最常见尺寸的套筒。一个坚固的帆布工具套 9468 可以夹在皮带上并停靠在 Wera 2go 系统上。

- 紧凑型 Zyklop 棘轮，带集成式批头库
- 磁性插座同时将 3/8" 棘轮变成 1/4" 批头安装架的棘轮螺丝刀
- 可自由转动的棘轮头，带 5 种预设的锁定位置
- 细齿可逆棘轮 (72 齿)，低回转角仅 5°
- 固定式和旋转式批头库，便于批头的拆卸和安全存放
- 带不锈钢衬套和强磁接杆，可作为延伸
- 将坚固的帆布工具套连接到皮带上并停靠在 Wera 2go 系统上

8009 Zyklop 随身袋组套 2



Code	EAN		
05004281001	4013288 223050		1
		8009 1x 3/8"x1/4"x133,0	
		893/1/1 1x 1/4"x75	
		851/1 BTZ 1x PH 1x25; 1x PH 2x25	
		855/1 BTZ 1x PZ 1x25; 1x PZ 2x25	
		867/1 TORX® BTZ 1x TX 10x25; 1x TX 15x25; 1x TX 20x25; 1x TX 25x25	
		840/1 BTZ 1x 3,0x25; 1x 4,0x25; 1x 5,0x25; 1x 6,0x25	
		8790 HMB 1x 8,0x29,0; 1x 10,0x29,0; 1x 13,0x29,0	
		9468 1x 155,0x65,0	
		魔术贴 70 1x 50,0x70,0	

8009 Zyklop 随身袋组套 Imperial 2



Code	EAN		
05004283001	4013288 223067		1
		8009 1x 3/8"x1/4"x133,0	
		893/1/1 1x 1/4"x75	
		851/1 BTZ 1x PH 1x25; 1x PH 2x25	
		867/1 TORX® BTZ 1x TX 10x25; 1x TX 15x25; 1x TX 20x25; 1x TX 25x25	
		840/1 Z 1x 1/8"x25; 1x 5/32"x25; 1x 3/16"x25; 1x 1/4"x25	
		868/1 Z 1x # 1x25; 1x # 2x25	
		8790 HMB 1x 5/16"x29,0; 1x 3/8"x29,0; 1x 1/2"x29,0	
		9468 1x 155,0x65,0	
		魔术贴 70 1x 50,0x70,0	

Zyklop 插袋

完整且节约空间的棘轮/螺丝刀组合。紧凑的 Zyklop 棘轮，带有插槽的钻头库。

1/4" 批头和 3/8" 套筒的磁性直接安装。得益于未上锁支架，可以快速更换工具。由于头部可在 0°、15° 和 90° 位置锁定，因此工具可用作棘轮和棘轮螺丝刀。

72 齿细齿机构，5° 较小回转角。由于手柄中集成了 12 个批头，应用范围很广。

牢固的棘轮机构可以实现足够的扭矩。Zyklop 棘轮与 12 件螺丝刀组套的完美组合。

75 mm 长的通用支架可用于 1/4" 批头的扩展。包括最常见尺寸的套筒。在帆布袋内，可以停靠在 Wera 2go 系统上。

- 紧凑型 Zyklop 棘轮，带集成式批头库
- 磁性插座同时将 3/8" 棘轮变成 1/4" 批头安装架的棘轮螺丝刀
- 可自由转动的棘轮头，带 5 种预设的锁定位置
- 细齿可逆棘轮 (72 齿)，低回转角仅 5°
- 固定式和旋转式批头库，便于批头的拆卸和安全存放

8009 Zyklop 插袋组套 3



Code	EAN		
05004284001	227560		1
		8009 1x 3/8"x1/4"x133,0	
		8794 SB 1x 3/8"x125,0	
		893/1/1 1x 1/4"x75	
		8790 HMB 1x 6,0x29,0; 1x 7,0x29,0; 1x 8,0x29,0; 1x 9,0x29,0; 1x 10,0x29,0; 1x 11,0x29,0; 1x 12,0x29,0; 1x 13,0x29,0; 1x 14,0x29,0; 1x 15,0x29,0; 1x 16,0x30,0; 1x 17,0x30,0	
		851/1 BTZ 1x PH 1x25; 1x PH 2x25	
		855/1 BTZ 1x PZ 1x25; 1x PZ 2x25	
		867/1 TORX® BTZ 1x TX 10x25; 1x TX 15x25; 1x TX 20x25; 1x TX 25x25	
		840/1 BTZ 1x 3,0x25; 1x 4,0x25; 1x 5,0x25; 1x 6,0x25	
		魔术贴 120 1x 50,0x120,0	

8009 Zyklop 插袋组套 4



Code	EAN		
05004285001	227591		1
		8009 1x 3/8"x1/4"x133,0	
		8794 SB 1x 3/8"x125,0	
		893/1/1 1x 1/4"x75	
		8790 HMB 1x 8,0x29,0; 1x 9,0x29,0; 1x 10,0x29,0; 1x 12,0x29,0; 1x 14,0x29,0; 1x 16,0x30,0; 1x 1/4"x29,0; 1x 3/16"x29,0; 1x 3/8"x29,0; 1x 7/16"x29,0; 1x 1/2"x29,0; 1x 9/16"x29,0	
		851/1 BTZ 1x PH 1x25; 1x PH 2x25	
		867/1 TORX® BTZ 1x TX 10x25; 1x TX 15x25	
		800/1 BTZ 1x 0,8x5,5x25; 1x 1,2x6,5x25	
		840/1 BTZ 1x 4,0x25; 1x 6,0x25	
		840/1 Z 1x 3/16"x25; 1x 1/4"x25	
		868/1 Z 1x # 1x25; 1x # 2x25	
		魔术贴 120 1x 50,0x120,0	

Koloss – 最棒的锤型棘轮扳手

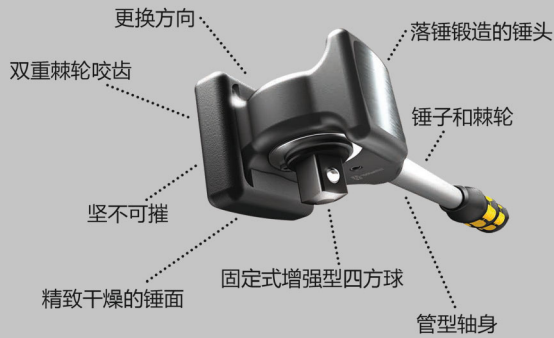

许多用户都会把他们的棘轮扳手当作锤子使用，但这通常会造成对棘轮头的破坏。因此我们开发了重型 Koloss 棘轮扳手，它的棘轮结构几乎不会被冲击所破坏。

Koloss 非常坚固，甚至可以安全地使用延长杆进行作业。经过硬化处理的驱动头采用全封闭设计，应对高强度的工作得心应手。

整体锻造的锤头与锤柄用膨胀铆钉铆接，形成坚固的T型结构，保证了一个几乎不可拆卸的锤头在手柄上的位置。通过连接维拉Koloss 8002 C延长杆可增强扭矩。

- 可承载至少600Nm的负荷
- 推杆头可进行左右换向
- 可用作手锤
- Kraftform多重材料手柄，有效抵抗压力、冲击和拉伸载荷
- 细齿棘轮结构和小至6°的回转角

8002 C Koloss 锤用棘轮扳手套组 · 1/2" 驱动



Code	EAN		
	4013288		
05133862001	162403		1
		8002 C 1x 1/2"x341,0	
		8782 C 1x 2x50,0	
		8780 C 1x 341,0x137	
		8000 E 1x 40,5	
		8000 HLF 1x 175,0x75,0	

8002 C Koloss 1/2" · 1/2" 驱动



Code	EAN		
	4013288		
05003692001	144607		1
		8002 C 1x 1/2"x341,0	
		8782 C 1x 2x50,0	
		8000 HLF 1x 175,0x75,0	

8780 C Koloss 延长杆

Koloss延长杆可与维拉Koloss 8002 C一同使用。可增加传递的扭力。Kraftform多重材料手柄，有效抵抗压力和拉伸载荷。具有韧性，回火铬钼钢锻造。激光蚀刻的安全说明可永久识别。

8780 C Koloss 延长杆



	EAN	⌀	⌀							
Code	4013288	mm	mm							
05003695001	144614	341,0	137							1

8781 C Koloss 中心销

Koloss中心销可与维拉Koloss 8002 C一同使用。用于对准吊耳或钻孔。锥形销。坚韧的、经硬化处理的铬钼钢制成。

8781 C Koloss 中心销



	EAN	⌀	⌀							
Code	4013288	mm	mm							
05003696001	144683	50	135,0							1

8782 C Koloss 垫片

Koloss垫片可与维拉Koloss 8002 C一同使用，作为锤面的保护。用于保护材料和表面。热塑性弹性体材料，以实现持久弹性，提供极大保护。

8782 C Koloss 垫片



	EAN		□							
Code	4013288	#	mm							
05003697001	144690	2	50,0							1

8000 E 延长杆释放销



	EAN	⌀								
Code	4013288	mm								
05136400001	194633	40,5								1

套筒条带 (织物带) C · 6个位置

- 套筒条带 (空)，可装入6个½"驱动的套筒或旋具套筒
- 带方便的弹簧扣
- 平滑的拧开解锁设计使得套筒的保存更安全，使用更方便
- 可附着到墙壁、架子、工具车和维拉2go系列产品上

套筒条带 (织物带) C · 6个位置



Code	EAN									
05003892001	205797									1

Belt C 0/6
1x 45,0x275,0

魔术贴 30
1x 30,0x200,0

9602 套筒磁性条带 · 1/2" · 空

1 套筒条带, 空。用于至多 10 件套筒和/或批头套筒, 1/2" 驱动。

条带可暂时吸附到金属表面, 含拧转解锁设计, 确保安全固定收纳套筒套筒。

- 条带含便于取用的套筒旋转扣支座, 用于暂时安装到墙壁、柜子、车间用滚轮小车
- 平滑的拧开解锁设计使得套筒的保存更安全, 使用更方便
- 空, 用于至多 10 件套筒, 1/2"

9602 套筒磁性条带 · 1/2" · 空

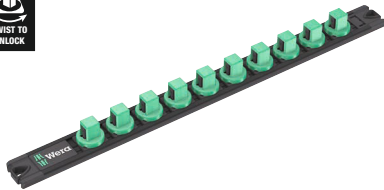

	EAN								
Code	4013288	mm	mm						
05136422001	223340	30,0	370,0						1

套筒条带 (织物带) C Impaktor · 9 个位置



Code	EAN									
05003893001	211484								1	
				Belt C Impaktor 0/9 1x 71,0x210,0						
				魔术贴 30 1x 30,0x200,0						

Zyklop Mini- 美丽的化身

Zyklop Mini 1
在没有足够空间激活棘轮时, 可以用手指快速驱动拨盘。

Zyklop Mini 2
Zyklop Mini 2 可直接接驳维拉8790 FA Zyklop套筒, 纤细的特征使其成为狭小空间作业的理想工具。

Zyklop Mini 3
迷你棘轮用于装配 1/4" 螺帽。



Zyklop Mini 1 & 2 & 3
棘轮采用60齿细齿结构, 6°回转角是精密作业的理想选择。

Zyklop Mini 1 & 2 & 3
交换。只需左右拨动换向开关。

Zyklop Mini 1 & 2 & 3
纤细型设计使其非常适合在狭小空间内工作。

集靓丽的外形和不可思议的弹性于一身! 即使在狭窄空间内也能快速进行紧固作业, 维拉 Zyklop Mini 专为空间不足以使用电动工具或传统螺丝刀的情况而设计。

Zyklop Mini 1能承担至少65 Nm的力, 远高于一般能在这么小的工具上传输的力量。

- 紧凑, 口袋大小
- 维拉迷你棘轮扳手, 即使在狭小空间也能快速拆装螺丝
- 狭小空间作业的理想工具
- 坚固而具有韧性的通用批头
- 实用而坚固的Bit-Check套装

Bit-Check 30 Zyklop Mini 1 组套



Code	EAN			
05073640001	144652			1
			8001 A 1x 1/4"x87,0	
		○	870/1 1x 1/4"x25 ¹⁾	
		●	889/4/1 K 1x 1/4"x50	
		+	851/1 TZ PH 2x PH 1x25; 3x PH 2x25; 1x PH 3x25	
		+	855/1 TH PZ 1x PZ 1x25; 3x PZ 2x25; 1x PZ 3x25	
		✦	867/1 TZ TORX® 1x TX 10x25; 1x TX 15x25; 1x TX 20x25; 1x TX 25x25; 1x TX 30x25; 1x TX 40x25	
		✦	867/1 Z TORX® B0 1x TX 10x25; 1x TX 15x25; 1x TX 20x25; 1x TX 25x25; 1x TX 30x25	
		—	800/1 TZ 1x 1,0x5,5x25	
		○	840/1 Z Hex-Plus 1x 3,0x25; 1x 4,0x25; 1x 5,0x25; 1x 6,0x25; 1x 8,0x25	

¹⁾ 带摩擦球，用于手动螺母扳手套筒

Bit-Check 30 Zyklop Mini 2 组套



Code	EAN			
05346293001	145765			1
			8001 A 1x 1/4"x87,0	
		●	889/4/1 K 1x 1/4"x50	
		○	870/1 1x 1/4"x25 ¹⁾	
		+	851/1 TZ PH 2x PH 1x25; 3x PH 2x25; 1x PH 3x25	
		✦	867/1 TZ TORX® 1x TX 10x25; 1x TX 15x25; 1x TX 20x25; 1x TX 25x25; 1x TX 30x25; 1x TX 40x25	
		✦	867/1 Z TORX® B0 1x TX 10x25; 1x TX 15x25; 1x TX 20x25; 1x TX 25x25; 1x TX 30x25	
		○	840/1 Z Hex-Plus 1x 3/32"x25; 1x 1/8"x25; 1x 5/32"x25; 1x 3/16"x25; 1x 1/4"x25	
		—	800/1 TZ 1x 1,0x5,5x25	
		○	868/1 Z 1x # 1x25; 3x # 2x25; 1x # 3x25	

¹⁾ 带摩擦球，用于手动螺母扳手套筒

KK Zyklop Mini 2 组套

可在非常狭小的空间拆装螺丝。通体全钢锻造的棘轮设计。

Zyklop 8790 FA套筒可用于直接接驳Zyklop Mini 2。

批头接杆、9个套筒、14个批头和1个转接头。

坚固的织物包装。

Tool-Check PLUS 组套

28个批头, 1个适用于DIN ISO 1173-C 6.3标准的 $\frac{1}{4}$ "六角驱动批头以及维拉系列1的批头的813手柄, 1个快速批头接杆, 1个870/1转接头 ($\frac{1}{4}$ "六角转接 $\frac{1}{4}$ "四角), 7个 $\frac{1}{4}$ "套筒, 1把维拉批头用棘轮扳手Zyklop Mini 1, 通体全钢锻造, 适用于DIN ISO 1173-C 6.3和E 6.3标准的 $\frac{1}{4}$ "六角驱动批头、以及维拉系列1和4的批头, 通过维拉870/1转接头可接驳 $\frac{1}{4}$ "套筒。

- 细齿棘轮结构和小至6°的回转角
- 非常坚固, 在扭矩方面无限制
- 拨杆便于换向
- 坚固而具有韧性的通用批头
- 实用而坚固的Bit-Check套装

KK Zyklop Mini 2 组套



Code	EAN		
05135918001	182180		1
		8001 A 1x $\frac{1}{4}$ "x87,0	
		8005 Zyklop Mini 2 组套 1x 107	
		813 1x $\frac{1}{4}$ "x78	
		870/1 1x $\frac{1}{4}$ "x25 ¹⁾	
		851/1 Z PH 1x PH 1x25; 1x PH 2x25	
		855/1 Z PZ 1x PZ 1x25; 1x PZ 2x25	
		867/1 TORX® 1x TX 10x25; 1x TX 15x25; 1x TX 20x25; 1x TX 25x25; 1x TX 30x25; 1x TX 40x25	
		840/1 Z Hex-Plus 1x 3,0x25; 1x 4,0x25; 1x 5,0x25; 1x 6,0x25	
		8790 FA 1x 4,0; 1x 5,0; 1x 5,5; 1x 6,0; 1x 7,0; 1x 8,0; 1x 10,0; 1x 12,0; 1x 13,0	
		魔术贴 120 1x 50,0x120,0	

¹⁾带摩擦球, 用于手动螺母扳手套筒

Tool-Check PLUS 组套



Code	EAN		
05056490001	4013288		1
	173003		
		8001 A 1x 1/4"x87,0	
		813 1x 1/4"x78	
		889/4/1 K 1x 1/4"x50	
		870/1 1x 1/4"x25 ¹⁾	
		8790 HMA 1x 5,5x23,0; 1x 6,0x23,0; 1x 7,0x23,0; 1x 8,0x23,0; 1x 10,0x23,0; 1x 12,0x23,0; 1x 13,0x23,0	
		851/1 TZ PH 2x PH 1x25; 3x PH 2x25; 1x PH 3x25	
		855/1 TH PZ 1x PZ 1x25; 3x PZ 2x25; 1x PZ 3x25	
		867/1 TZ TORX® 1x TX 10x25; 1x TX 15x25; 1x TX 20x25; 1x TX 25x25; 1x TX 30x25; 1x TX 40x25	
		867/1 Z TORX® B0 1x TX 10x25; 1x TX 15x25; 1x TX 20x25; 1x TX 25x25; 1x TX 30x25	
		840/1 Z Hex-Plus 1x 3,0x25; 1x 4,0x25; 1x 5,0x25; 1x 6,0x25; 1x 8,0x25	
		800/1 TZ 1x 1,0x5,5x25	

¹⁾ 带摩擦球，用于手动螺母扳手套筒
²⁾ 停产。新版预定于2025年6月1日推出。

Tool-Check PLUS 组套 · 英制



Code	EAN		
05056491001	4013288		1
	178756		
		8001 A 1x 1/4"x87,0	
		813 1x 1/4"x78	
		889/4/1 K 1x 1/4"x50	
		870/1 1x 1/4"x25 ¹⁾	
		8790 HMA 1x 3/16"x23,0; 1x 1/4"x23,0; 1x 5/16"x23,0; 1x 11/32"x23,0; 1x 3/8"x23,0; 1x 7/16"x23,0; 1x 1/2"x23,0	
		851/1 TZ PH 2x PH 1x25; 3x PH 2x25; 1x PH 3x25	
		800/1 TZ 1x 1,0x5,5x25	
		867/1 TZ TORX® 1x TX 10x25; 1x TX 15x25; 1x TX 20x25; 1x TX 25x25; 1x TX 30x25; 1x TX 40x25	
		867/1 Z TORX® B0 1x TX 10x25; 1x TX 15x25; 1x TX 20x25; 1x TX 25x25; 1x TX 30x25	
		840/1 Z Hex-Plus 1x 3/32"x25; 1x 1/8"x25; 1x 5/32"x25; 1x 3/16"x25; 1x 1/4"x25	
		868/1 V 1x # 1x25; 3x # 2x25; 1x # 3x25	

¹⁾ 带摩擦球，用于手动螺母扳手套筒
²⁾ 停产。新版预定于2025年6月1日推出。

Tool-Check 1 SB 组套

- 1/4"棘轮扳手、Z批头、快速接杆、转接头和1/4"套筒
- 狭小空间作业的理想工具
- 坚固而具有韧性的通用批头
- 通过维拉870/1转接头可接驳1/4"套筒
- “易寻”色标系统：用特定的颜色代表不同端头种类和尺寸

Tool-Check 1 SB 组套



Code	EAN		
05073220001	162526		1
		8001 A 1x 1/4"x87,0	
		870/1 1x 1/4"x25 ¹⁾	
		889/4/1 K 1x 1/4"x50	
		851/1 TZ PH 2x PH 1x25; 3x PH 2x25; 1x PH 3x25	
		855/1 TH PZ 1x PZ 1x25; 3x PZ 2x25; 1x PZ 3x25	
		867/1 TZ TORX® 1x TX 10x25; 1x TX 15x25; 1x TX 20x25; 1x TX 25x25; 1x TX 30x25; 1x TX 40x25	
		867/1 Z TORX® B0 1x TX 10x25; 1x TX 15x25; 1x TX 20x25; 1x TX 25x25; 1x TX 30x25	
		800/1 TZ 1x 1,0x5,5x25	
		840/1 Z Hex-Plus 1x 3,0x25; 1x 4,0x25; 1x 5,0x25; 1x 6,0x25; 1x 8,0x25	
		8790 HMA 1x 5,5x23,0; 1x 6,0x23,0; 1x 7,0x23,0; 1x 8,0x23,0; 1x 10,0x23,0; 1x 12,0x23,0; 1x 13,0x23,0	

¹⁾ 带摩擦球，用于手动螺母扳手套筒

²⁾ 停产。新版预定于2025年6月1日推出。

Tool-Check Automotive 1 组套



Code	EAN		
05200995001	165343		1
		8001 A 1x 1/4"x87,0	
		870/1 1x 1/4"x25 ¹⁾	
		889/4/1 K 1x 1/4"x50	
		851/1 TZ PH 1x PH 1x25; 1x PH 2x25; 1x PH 3x25	
		867/1 TZ TORX® 1x TX 10x25; 1x TX 15x25; 1x TX 20x25; 1x TX 25x25; 1x TX 30x25; 1x TX 40x25	
		867/1 Z TORX® B0 1x TX 10x25; 1x TX 15x25; 1x TX 20x25; 1x TX 25x25; 1x TX 30x25	
		800/1 TZ 1x 1,0x5,5x25	
		840/1 Z Hex-Plus 1x 3,0x25; 1x 4,0x25; 1x 5,0x25; 1x 6,0x25; 1x 8,0x25	
		860/1 XZN 1x M 4x25; 1x M 5x25; 1x M 6x25; 1x M 8x25	
		873/1 Five Lobe 1x 20x25; 1x 25x25; 1x 27x25; 1x 30x25	
		8790 HMA 1x 5,5x23,0; 1x 6,0x23,0; 1x 7,0x23,0; 1x 8,0x23,0; 1x 10,0x23,0; 1x 12,0x23,0; 1x 13,0x23,0	

¹⁾ 带摩擦球，用于手动螺母扳手套筒

²⁾ 停产。新版预定于2025年6月1日推出。

Bit-Check 10 Zyklop Mini BiTorsion 1

9个批头, 采用双重抗扭设计, 可延长使用寿命, 具有超强韧性, 通用型。带“易寻”色标系统: 通过颜色标识 (红色=十字; 黑色=米字; 绿色=TORX®梅花; 蓝色=六角) 和尺寸标示可轻松找到所需批头, 1把维拉Zyklop Mini 1批头用棘轮扳手, 通体全钢锻造, 用于DIN ISO 1173-C 6.3和E 6.3标准的 $\frac{1}{4}$ "六角批头、以及维拉系列1和4的批头。也可通过维拉870/1转接头接驳 $\frac{1}{4}$ "套筒。

- 维拉迷你棘轮扳手, 即使在狭小空间也能快速拆装螺丝

Bit-Check 10 Zyklop Mini BiTorsion 1



Code	EAN		
05057418001	4013288 195951		1
		8001 A 1x $\frac{1}{4}$ "x87,0	
		851/1 BTZ PH 1x PH 1x25; 1x PH 2x25	
		855/1 BTZ PZ 1x PZ 1x25; 1x PZ 2x25	
		867/1 TORX® BTZ 1x TX 15x25; 1x TX 20x25; 1x TX 25x25	
		840/1 BTZ Hex-Plus 1x 4,0x25; 1x 5,0x25	

Bit-Check 10 Zyklop Mini 1 组套

多种工具置于最小空间内。按刀头和尺寸分类, 便于快速查找。维拉精密棘轮: 落锻全钢设计。

60 齿细齿机构, 小至 6° 回转角, 用于精密作业。

左/右简单切换。棘轮头和手柄符合人体工程学设计。

- 坚固而具有韧性的通用批头

Bit-Check 10 Zyklop Mini 1 组套



Code	EAN		
05073645001	4013288 168115		1
		8001 A 1x $\frac{1}{4}$ "x87,0	
		851/1 Z PH 1x PH 1x25; 1x PH 2x25	
		855/1 Z PZ 1x PZ 1x25; 1x PZ 2x25	
		867/1 TORX® 1x TX 15x25; 1x TX 20x25; 1x TX 25x25	
		840/1 Z Hex-Plus 1x 4,0x25; 1x 5,0x25	

自行车工具组套 1

维拉为了热爱自行车运动和自行车专业修理业者们设计, 携带轻便的自行车工具组套 1, 收纳在紧凑不占空间的织布包, 同时让您在行车时也可以处理更多不同的情况。

坚固的织布包收纳了Zyklop Mini 1批头用迷你棘轮和10个维拉严选的可应用在自行车上的通用批头。

配玻璃纤维加固塑料轮胎千斤顶, 轮胎可以安全脱离轮辋而不损坏轮辋。

- 紧凑的 14 件拧紧工具组套, 用于自行车应用, 便携
- 产品系列实用性强, 可用于个别实施装配操作和维修
- 适用于公路车, 登山车和电动自行车的通用批头组套
- 坚固且表面触感良好的紧凑可折叠式织布包
- 组套含精密棘轮批头、延长杆和 2 个轮胎千斤顶, 配附加功能

自行车工具组套 1



Code	EAN		
	4013288		
05004170001	207623		1
		8001 A 1x 1/4"x87,0	
		3899/4/1 1x 1/4"x100	
		851/1 Z PH 1x PH 2x25	
		867/1 TORX® 1x TX 10x25; 1x TX 25x25	
		840/1 Z Hex-Plus 1x 2,0x25; 1x 2,5x25; 1x 3,0x25; 1x 4,0x25; 1x 5,0x25; 1x 6,0x25; 1x 8,0x25	
		9502 1x 105.0	
		9503 1x 105.0	
		魔术贴 70 1x 50,0x70,0	

自行车组件3

自行车工具组件，带棘轮、批头、套筒和接杆，采用紧凑式空间设计。尤其适合作为通用型随身工具，用于完成各类旋拧应用。

高质量的Kraftform Plus手柄，符合人体工程学设计，使用舒适，可避免手上起泡和老茧。硬质握持区域，方便更快速灵活的旋拧操作，软质握持区域则便于高扭矩传输。

在狭窄的空间而无法进行机械工具或传统手动工具时，使用Zyklus Mini 1迷你棘轮可实现快速操作。

通过方向切换杆，可实现从左到右以及反向的快速切换。

可在开槽棘轮头上快速旋转使用大拇指激活棘轮。

即使用单手，操作也十分简单。符合人体工程学原理的棘轮头/换向杆：Kraftform几何体具有完美构型设计的手指接触表面。

批头可直接装入棘轮头，以及极为精细的工具设计，可在较低的挡位进行操作。

6°的小返回角度，便于精准的操作。坚固耐用的落锻全钢式设计。应用扭矩可大于65 Nm。Rapidaptor快速接头附带快速衬套，可作为扩展件使用，仅需单手即可更换批头，无需辅助工具，即使是极小尺寸的批头也不例外。

耐用的通用型批头。手动和机械（非冲击型）套筒。“易寻”色标系统，可轻松找到所需尺寸花形。

即便是手上有油，也能轻松握紧。配备球锁。用于外六角螺栓和套筒。采亚光镀铬的铬钒合金材质

- 紧凑的 41 件拧紧工具组套，用于自行车作业，便携
- 产品系列实用性强，可用于个别实施装配操作和维修
- 囊括自行车上最常见花形的工具，适用于道路自行车、山地自行车和电动自行车
- 带“易寻”色标系统，可轻松找到所需套筒。
- 构造牢固，表面设计良好，紧凑式轻量织物袋
- 含 2 个轮胎千斤顶，配附加功能

自行车组件3



Code	EAN		
05004172001	4013288 211248		1
		8001 A 1x 1/4"x87,0	
		813 1x 1/4"x78	
		889/4/1 K 1x 1/4"x50	
		870/1 1x 1/4"x25 ¹⁾	
		8790 HMA 1x 5,5x23,0; 1x 6,0x23,0; 1x 7,0x23,0; 1x 8,0x23,0; 1x 10,0x23,0; 1x 13,0x23,0; 1x 15,0x23,0	
		851/1 TZ PH 1x PH 1x25; 2x PH 2x25; 1x PH 3x25	
		867/1 TZ TORX® 1x TX 10x25; 1x TX 15x25; 2x TX 20x25; 2x TX 25x25; 1x TX 27x25; 1x TX 30x25; 1x TX 40x25	
		800/1 TZ 1x 0,5x4,0x25; 1x 0,6x4,5x25; 1x 1,0x5,5x25	
		840/1 Z Hex-Plus 1x 2,0x25; 1x 2,5x25; 1x 3,0x25; 1x 4,0x25; 1x 5,0x25; 1x 6,0x25; 1x 8,0x25	
		842/1 Z 1x 2,5x25; 1x 3,0x25; 1x 4,0x25; 1x 5,0x25; 1x 6,0x25	
		9502 1x 105.0	
		9503 1x 105.0	
		魔术贴 120 1x 50,0x120,0	

¹⁾ 带摩擦球，用于手动螺母扳手套筒

²⁾ 停产。新版预定于2025年6月1日推出。

自行车组套 3 A

棘轮、批头、套筒和批头夹持螺丝刀在最小空间内的自行车工具组套。是众多旋拧应用的完美通用配套工具。外加：组套带有两个袋子——一个大的工具袋，里面装下完整的工具组套，还有一个小的软工具袋，外出工作时可以将工具安全地放入衬衫口袋内随身携带。软工具袋有额外的环可以夹持二氧化碳贮气瓶（贮气瓶不包含其中）。

使用有用的自行车工具（铆钉机和链条止锁件）维修自行车链条。

优质批头夹持螺丝刀，带Kraftform Plus 手柄，符合人体工学设计的旋拧操作舒适。由于空间限制，无法使用机器或常规手动工具进行旋拧时，使用棘轮进行快速工作。从顺时针到逆时针旋转的快速反转，反之亦然。棘轮头上的滚花允许快速旋转（使用拇指）。单手即可轻松操作。棘轮/拨杆符合人体工程学。Kraftform 几何结构形状完美，贴合手指。由于棘轮头直接安装批头，工具设计小，适用于低工作高度。小至 6° 回转角，精密作业。落锻全钢设计，坚固无比。扭矩超过 65 Nm。带快速旋转套筒的快速齿轮批头夹持螺丝刀：可以用作延伸，无需额外的工具，仅用一只手即可用于即使是极小批头尺寸的超快速批头更换。

用特定颜色代表不同端头种类和尺寸的 Zyklop 套筒 - 有助于轻松快速查找所需批头。后端的滚花可以防滑，即使手有油污也能轻松处理。带有球挡槽。用于外六角螺丝和螺栓。由暗铬钒制成。

配玻璃纤维加固塑料轮胎杆，轮胎可以安全脱离轮辋而不损坏轮辋。1 个配顶出阀的轮胎千斤顶、1 个配 1/4" 批头支座的轮胎千斤顶。

- 紧凑的 41 件拧紧工具组套，用于自行车作业，便携
- 产品系列实用性强，可用于个别实施装配操作和维修
- 囊括自行车上最常见花形的工具，适用于道路自行车、山地自行车和电动自行车
- 带“易寻”色标系统，可轻松找到所需套筒
- 构造牢固，表面设计良好，紧凑型轻量织物袋
- 含 2 个轮胎千斤顶，配附加功能

自行车组套 3 A



Code	EAN		
	4013288		
05004183001	227607		1
		8001 A 1x 1/4"x87,0	
		813 1x 1/4"x78	
		1 年 4 月 3899 日 1x 1/4"x100	
		889/4/1 K 1x 1/4"x50	
		870/1 1x 1/4"x25 ¹⁾	
		8790 HMA 1x 5,5x23,0; 1x 6,0x23,0; 1x 8,0x23,0; 1x 9,0x23,0; 1x 10,0x23,0; 1x 13,0x23,0; 1x 15,0x23,0	
		851/1 TZ 1x PH 1x25; 1x PH 2x25	
		867/1 TZ TORX® 1x TX 10x25; 1x TX 15x25; 1x TX 20x25; 1x TX 25x25; 1x TX 27x25; 1x TX 30x25	
		800/1 TZ 1x 0,5x4,0x25; 1x 0,6x4,5x25	
		840/1 Z 1x 2,0x25; 1x 2,5x25; 1x 3,0x25; 1x 4,0x25; 1x 5,0x25; 1x 6,0x25; 1x 8,0x25	
		842/1 Z 1x 2,5x25; 1x 3,0x25; 1x 4,0x25; 1x 5,0x25; 1x 6,0x25	
		9502 1x 105,0	
		9503 1x 105,0	
		9513 Chain 工具	
		9512 Chain-Hook	
		9481 1x 203,0x85,0	
		9480 1x 90,0x135,0	
		魔术贴 120 1x 50,0x120,0	

¹⁾ 带摩擦球，用于手动螺母扳手套筒

²⁾ 停产。新版预定于2025年6月1日推出。

自行车组套 9

大量自行车工具安排在紧密包装内。9 个不锈钢批头以不同刀头和尺寸分类, 以便快速查找所需工具。含 1 个维拉 Zyklop Mini 1 批头棘轮, 配落槌锻造。





60 齿细齿机构, 6° 较小回转角, 用于精密作业。姆指旋转轮可在无棘轮作业空间的条件下实现快速拧紧。左/右简单切换。棘轮头和手柄符合人体工程学设计。

含“易寻”色标系统用特定颜色代表不同刀头种类和尺寸, 有助于轻松快速查找所需工具。

- 10 件 Zyklop Mini 组套
- 迷你棘轮用于装配 1/4" 螺帽
- 通体落锻全钢式设计, 可应用于大于 65 Nm 的扭矩值
- 细齿棘轮结构和小至 6° 的回转角
- 不锈钢批头

自行车组套 9



Code	EAN		
05004177001	4013288 220646		 1
		 8001 A 1x 1/4"x87,0	
		 3851/1 TS PH 1x PH 2x25	
		 3867/1 TS TORX® 1x TX 10x25; 1x TX 25x25	
		 3840/1 TS 1x 2,0x25; 1x 2,5x25; 1x 3,0x25; 1x 4,0x25; 1x 5,0x25; 1x 6,0x25	

8001 A Zyklop Mini 1 SB 批头用棘轮扳手 1/4" · 1/4" 驱动

适用于狭窄区域的作业。棘轮采用60齿细齿结构, 6°回转角是精密作业的理想选择。

在没有足够空间激活棘轮时, 可以用手指快速驱动拨盘。

纤细型设计使其非常适合在狭小空间内工作。

Zyklop Mini 能承受至少65 Nm的力, 远高于一般能在这么小的工具上传输的力量。

- 用于1/4"六角头驱动的批头夹具
- 通体全钢锻造的设计
- 扭矩大于65 Nm
- 细齿棘轮结构和小至6°的回转角
- 狭小空间作业的理想工具

8001 A Zyklop Mini 1 SB 批头用棘轮扳手 1/4" · 1/4" 驱动



Code	EAN		
05073230001	144638		1
		● 8001 A 1x 1/4"x87,0	
		○ 870/1 1x 1/4"x25 ¹⁾	

¹⁾ 带摩擦球, 用于手动螺母扳手套筒

8005 Zyklop Mini 2 组套

Zyklop Mini 2可直接接驳维拉8790 FA Zyklop套筒, 纤细的特征使其成为狭小空间作业的理想工具。

- 可与专门的Zyklop套筒直接接驳
- 小至6°的回转角, 用于精密作业
- 只需左右拨动换向开关
- 狭小空间作业的理想工具

8005 Zyklop Mini 2 组套



Code	EAN	⌀							
05003660001	179616	107							1

8008 A Zyklop Mini 3 棘轮扳手 · 1/4" 驱动

Wera Zyklop Mini 3棘轮, 1/4"驱动。操作极为简单, 即使用单手, 也能在狭小空间完成旋拧。

坚固耐用的通体落锻全钢式设计。

精细的轮齿机构, 60个轮齿, 可进行6°小角度返回的精准操作。在没有棘轮操作空间的情况, 使用带有滚花的棘轮片也可用手指激活棘轮进行快速旋拧操作。

左/右切换操作简单。棘轮头和调节杆外形设计符合人机工程学原理随附。

- 迷你棘轮用于装配 1/4" 螺帽
- 通体落锻全钢式设计, 可应用于大于65 Nm的扭矩值。
- 细齿棘轮结构和小至6°的回转角
- 只需左右拨动换向开关
- 狭小空间作业的理想工具

8008 A Zyklop Mini 3 棘轮扳手 · 1/4" 驱动



Code	EAN	Icon	mm						
05003793001	211699	1/4"	87,0						1

8790 FA Zyklop 套筒 · 1/4" 和六角 11 驱动

Zyklop Mini 2可直接接驳维拉8790 FA Zyklop套筒, 纤细的特征使其成为狭小空间作业的理想工具。

8790 FA Zyklop 套筒 · 1/4" 和六角 11 驱动



	EAN	Icon	mm	mm	mm	mm	mm		
Code	4013288	mm	mm	mm	mm	mm	mm		
05003665001	179623	4,0	9,5	6,4	11,8	18,0			1
05003666001	179630	4,5	9,5	7,0	11,8	18,0			1
05003667001	179647	5,0	9,5	7,6	11,8	18,0			1
05003668001	179654	5,5	9,5	8,2	11,8	18,0			1
05003669001	179661	6,0	9,5	9,2	11,8	18,0			1
05003670001	183408	7,0	9,5	10,4	11,8	18,0			1
05003675001	179678	8,0	9,5	11,5	11,8	18,0			1
05003690001	179685	10,0	9,5	13,8	11,8	18,0			1
05003684001	183415	12,0	9,5	16,8	11,8	18,0			1
05003685001	179692	13,0	9,5	17,8	11,8	18,0			1





Joker 扳手

Joker 棘轮两用扳手 – 让应用更灵活



Joker系列的固定功能意味着螺栓和螺帽能被扳手头固定并轻松定位。因为采用了创新的特殊挡块来固定紧固件，它可快速、安全地进行紧固，从而避免浪费时间去寻找掉落的螺栓和螺帽！螺栓或螺帽定位好后，就可以快速地进行紧固，而无需使用任何额外的工具。扳手很难定位吗？在有限的空间内很难固定紧固件吗？想避免人员受伤或紧固件被损坏的风险吗？这些都是过去的事了。现在再也不需要用手固定螺栓了，Joker的限位挡块可以防止它从紧固件头部滑落，这使得作业更轻松，也可将更多的力量用于紧固工作。Joker巧妙地应用双六角几何形状，为螺帽或螺栓提供了一个非常有效的连接。同时Joker口部带有加硬化处理过的可替换金属挡块，其细微的硬齿可以牢牢咬住螺帽。这两个特点结合起来，使其即使在较高的扭矩下，也可以防止工具打滑。尤其是在狭小空间内，传统的60°回转角扳手必须翻来翻去才能紧固或松开螺栓或者螺帽，而Joker独特的双六角设计使其回转角只有30°。加上直型颈部，作业时不再需要翻转扳手。在传统的开口扳手无法使用的狭小空间内，Joker可以轻松紧固或松动螺栓和螺母。即使是在用螺栓连接管道时，Joker的限位挡块和极小回转角的完美配合也能让您有效地工作。棘轮带80细齿，即便在非常狭小空间作业里也有较好的灵活性。用特定的颜色代表不同花形，再辅以简洁的尺寸标示，让寻找工具变得简单快速。带“易寻”色标系统的工具包括：用于驱动内六角螺丝的工具（L型扳手、Zyklop旋具套筒）、用于驱动外六角螺丝的工具（Joker扳手、带固持功能的Zyklop套筒和Zyklop旋具套筒）、以及用于驱动TORX®梅花螺丝的工具（L型扳手、Zyklop旋具套筒）。

- 夹口的金属挡板可提供实用的固持功能
- 限位挡块防止滑落
- 双六角几何形状有效降低了滑落的危险
- 小至30°的回转角
- “易寻”色标系统：用特定的颜色代表不同端头种类和尺寸

6000 Joker 棘轮两用扳手



	EAN							
Code	4013288		mm	mm	mm	mm	mm	
05073268001	167309		8	144	20	5,5	18	3
05073270001	164360		10	159	22	5,5	21	3
05073271001	167316		11	165	25	6,3	22	3
05073272001	167323		12	170,7	26,3	6,6	25	3
05073273001	164377		13	177	27,3	7	25	3
05073274001	167330		14	188	29,3	7,5	28	3
05073275001	167347		15	200	32,3	7,8	28,5	3
05073276001	167392		16	212	35	8,2	32,7	3
05073277001	164384		17	224	37,2	8,5	32,7	3
05073278001	167408		18	235	39	9	33,8	3
05073279001	164391		19	246	42	9,5	34,8	3

6000 Joker 棘轮两用扳手 · 英制



	EAN							
Code	4013288			mm	mm	mm	mm	
05073280001	167354		5/16"	144	20	5,5	18	3
05073281001	167361		3/8"	159	22	5,5	21	3
05073282001	167378		7/16"	165	25	6,3	22	3
05073283001	167385		1/2"	177	27,3	7	25	3
05073284001	167415		9/16"	188	29,3	7,5	28	3
05073285001	167422		5/8"	212	35	8,2	32,7	3
05073286001	167439		11/16"	235	39	9	33,8	3
05073287001	167446		3/4"	246	42	9,5	34,8	3

9630 磁性条带 6000 Joker 1 环形棘轮扳手组套

- 11 件组套<
- 凭借其强大的磁性, 该条可以牢牢地吸附在金属表面。条带也可以用螺栓固定在墙上
- 条形端头完全固定住工具

9630 磁性条带 6000 Joker 1 环形棘轮扳手组套



Code	EAN		
05020014001	228949		1
		6000 Joker 1x 8x144; 1x 10x159; 1x 11x165; 1x 12x170.7; 1x 13x177; 1x 14x188; 1x 15x200; 1x 16x212; 1x 17x224; 1x 18x235; 1x 19x246	
		9610 1x 30,0x370,0	

9631 磁性条带 6000 Joker 2 环形棘轮扳手组套

- 5 件组套

9631 磁性条带 6000 Joker 2 环形棘轮扳手组套



Code	EAN		
05020015001	229847		1
		6000 Joker 1x 8x144; 1x 10x159; 1x 13x177; 1x 17x224; 1x 19x246	
		9610 1x 30,0x370,0	

9632 磁性条带 6000 Joker Imperial 1 环形棘轮扳手组套

- 8 件组套

9632 磁性条带 6000 Joker Imperial 1 环形棘轮扳手组套



Code	EAN		
05020016001	229861		1
		6000 Joker Imperial 1x 5/16"x144; 1x 3/8"x159; 1x 7/16"x165; 1x 1/2"x177; 1x 9/16"x188; 1x 5/8"x212; 1x 11/16"x235; 1x 3/4"x246	
		9610 1x 30,0x370,0	

6000 Joker 11 Set 1 棘轮两用扳手组套

- 坚固的帆布腰包装

6000 Joker 11 Set 1 棘轮两用扳手组套



Code		EAN		
		4013288		
05020013001	167521			1
6000 Joker 1x 8x144; 1x 10x159; 1x 11x165; 1x 12x170,7; 1x 13x177; 1x 14x188; 1x 15x200; 1x 16x212; 1x 17x224; 1x 18x235; 1x 19x246				

6000 Joker 8 Imperial Set 1 棘轮两用扳手组套 · 英制

- 坚固的帆布腰包装

6000 Joker 8 Imperial Set 1 棘轮两用扳手组套 · 英制

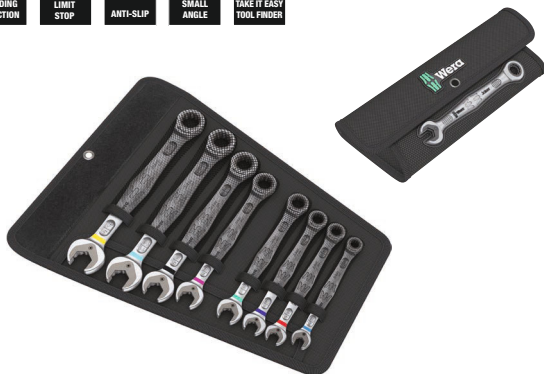

Code		EAN		
		4013288		
05020012001	167514			1
6000 Joker Imperial 1x 5/16"x144; 1x 3/8"x159; 1x 7/16"x165; 1x 1/2"x177; 1x 9/16"x188; 1x 5/8"x212; 1x 11/16"x235; 1x 3/4"x246				

6000/6002 Joker 6 Set 1 棘轮两用扳手/双开口扳手组套

- 两端开口的Joker扳手非常适合拆卸螺栓和螺帽。
- 坚固的帆布腰包装

6000/6002 Joker 6 Set 1 棘轮两用扳手/双开口扳手组套



Code		EAN		
		4013288		
05020022001	173034			1
6000 Joker 1x 10x159; 1x 13x177; 1x 17x224; 1x 19x246 6002 Joker Double 1x 10x13x167; 1x 17x19x235				

6000 Joker 4 Set 1 棘轮两用扳手组套

- 坚固的帆布腰包装

6000 Joker 4 Set 1 棘轮两用扳手组套



Code		EAN		
		4013288		
05073290001	164407			1
6000 Joker 1x 10x159; 1x 13x177; 1x 17x224; 1x 19x246				

6000 Joker 4 Imperial Set 1 棘轮两用扳手组套 · 英制

- 坚固的帆布腰包装

6000 Joker 4 Imperial Set 1 棘轮两用扳手组套 · 英制



Code	EAN		
05073295001	167460		1
6000 Joker Imperial 1x 7/16"x165; 1x 1/2"x177; 1x 9/16"x188; 1x 3/4"x246			
魔术贴 120 1x 50,0x120,0			

6001 Joker Switch

Joker系列的固定功能意味着螺栓和螺帽能被扳手头固定并轻松定位。因为采用了创新的特殊挡块来固定紧固件，它可快速、安全地进行紧固，从而避免浪费时间去寻找掉落的螺栓和螺帽！螺栓或螺帽定位好后，就可以快速地进行紧固，而无需使用任何额外的工具。扳手很难定位吗？在有限的空间内很难固定紧固件吗？想避免人员受伤或紧固件被损坏的风险吗？这些都是过去的事了。现在再也不需要用手指固定螺栓了，Joker的限位挡块可以防止它从紧固件头部滑落，这使得作业更轻松，也可将更多的力量用于紧固工作。

Joker巧妙地应用双六角几何形状，为螺帽或螺栓提供了一个非常有效的连接。同时Joker口部带有加硬化处理过的可替换金属挡块，其细微的硬齿可以牢牢咬住螺帽。这两个特点结合起来，使其即使在较高的扭矩下，也可以防止工具打滑。尤其是在狭小空间内，传统的60°回转角扳手必须翻来翻去才能紧固或松开螺栓或者螺帽，而Joker独特的双六角设计使其回转角只有30°。

加上直型颈部，作业时不再需要翻转扳手。在传统的开口扳手无法使用的狭小空间内，Joker可以轻松紧固或松动螺栓和螺母。即使是在用螺栓连接管道时，Joker的限位挡块和极小回转角的完美配合也能让您有效地工作。棘轮带80细齿，即便在非常狭小空间作业里也有较好的灵活性。用特定的颜色代表不同花形，再辅以简洁的尺寸标示，让寻找工具变得简单快速。带“易寻”色标系统的工具包括：用于驱动内六角螺丝的工具（L型扳手、Zyklop旋具套筒）、用于驱动外六角螺丝的工具（Joker扳手、带固持功能的Zyklop套筒和Zyklop旋具套筒）、以及用于驱动TORX®梅花螺丝的工具（L型扳手、Zyklop旋具套筒）。

- 夹口的金属挡板可提供实用的固持功能
- 限位挡块防止滑落
- 极小细齿和坚固的锁定机制
- 棘轮端成15°角
- “易寻”色标系统：用特定的颜色代表不同端头种类和尺寸

6001 Joker 拨杆换向棘轮两用扳手 · 带换向拨杆



Code	EAN		mm	mm	mm	mm	mm	
05020064001	184696		8	144	20,3	5,5	18	3
05020065001	183903		10	159	23	5,5	21,5	3
05020066001	183910		11	165	24,3	6,3	22	3
05020067001	183927		12	171	26,3	6,6	25	3
05020068001	184702		13	179	27,3	7	26	3
05020069001	184719		14	187	30	7,5	28	3
05020070001	184726		15	199	32	7,8	28,8	3
05020071001	184733		16	213	35	8,2	31,7	3
05020072001	184740		17	225	37	8,5	33	3
05020073001	184757		18	234	39,5	9	34	3
05020074001	184764		19	246	42	9,5	34,7	3

6001 Joker 拨杆换向棘轮两用扳手 · 带换向拨杆 · 英制



Code	EAN			mm	mm	mm	mm	
05020075001	184788		5/16"	144	20,3	5,5	18	3
05020076001	184795		3/8"	159	23	5,5	21,5	3
05020077001	184801		7/16"	165	24,3	6,3	22	3
05020078001	184818		1/2"	171	26,3	6,6	25	3
05020079001	184825		9/16"	187	30	7,5	28	3
05020080001	184832		5/8"	213	35	8,2	31,7	3
05020081001	184849		11/16"	234	39,5	9	34	3
05020082001	184771		3/4"	246	42	9,5	34,7	3

6001 Joker Switch 11 Set 1 拨杆换向棘轮两用扳手组套

- 紧凑而极为坚固的织物盒包装, 体积小而轻便

6001 Joker Switch 11 Set 1 拨杆换向棘轮两用扳手组套



Code	EAN		
05020091001	4013288 184160		1
		6001 Joker Switch 1x 8x144; 1x 10x159; 1x 11x165; 1x 12x171; 1x 13x179; 1x 14x187; 1x 15x199; 1x 16x213; 1x 17x225; 1x 18x234; 1x 19x246	
		魔术贴 240 1x 50,0x240,0	

6001 Joker Switch 8 Imperial Set 1 棘轮两用扳手组套

- 紧凑而极为坚固的织物盒包装, 体积小而轻便

6001 Joker Switch 8 Imperial Set 1 棘轮两用扳手组套



Code	EAN		
05020093001	4013288 184153		1
		6001 Joker Switch Imperial 1x 9/16"x144; 1x 3/8"x159; 1x 7/16"x165; 1x 1/2"x171; 1x 9/16"x187; 1x 5/8"x213; 1x 11/16"x234; 1x 3/4"x246	
		魔术贴 240 1x 50,0x240,0	

6001 Joker Switch 4 Set 1 拨杆换向棘轮两用扳手组套

- 坚固的帆布腰包装

6001 Joker Switch 4 Set 1 拨杆换向棘轮两用扳手组套



Code	EAN		
05020090001	4013288 184139		1
		6001 Joker Switch 1x 10x159; 1x 13x179; 1x 17x225; 1x 19x246	
		魔术贴 120 1x 50,0x120,0	

6001 Joker Switch 4 Imperial Set 1 拨杆换向棘轮两用扳手组套 · 英制

- 坚固的帆布腰包装

6001 Joker Switch 4 Imperial Set 1 拨杆换向棘轮两用扳手组套 · 英制



Code	EAN		
05020092001	4013288 184146		1
		6001 Joker Switch Imperial 1x 7/16"x165; 1x 1/2"x171; 1x 9/16"x187; 1x 3/4"x246	
		魔术贴 120 1x 50,0x120,0	

6002 Joker 双开口扳手

- 夹口的金属挡板可提供实用的固持功能
- 限位挡块防止滑落
- 双六角几何形状有效降低了滑落的危险
- 小至30°的回转角
- “易寻”色标系统: 用特定的颜色代表不同端头种类和尺寸

6002 Joker 双开口扳手



Code	EAN								
05020259001	219015		8	20	10	23	5,5	3	
05003760001	173010		10	23	13	27	5,5	3	
05003765001	173027		17	37	19	42	8,5	3	
05020260001	212764		20	48	22	51	10	3	
05020261001	212771		22	48	24	51	10	3	
05020262001	212788		24	51	27	60	11	3	
05020263001	212795		27	63	32	66	12	3	
05020264001	212801		30	63	32	66	12	3	

6003 Joker 组合扳手

针对日益狭小的螺丝作业空间, 专业工具尤为必要。狭小空间对工具的接触面有着更高要求。如何对开口扳手进行改造, 以扩大工具的使用范围?

我们将回转角7.5°的开口结合双六角几何形状, 增加了一倍的接触面。当扳手沿纵轴转动180°时, 产生四种对接可能性。

螺栓和螺帽均可在15°内完成适配。

有着特殊开口形状的Joker 6003, 显著拓展了扳手在狭小空间的应用范围。Joker 6003换向后可直接装配。狭长且坚固的环形扳手可沿工具轴身倾斜15°。

高品质表面经特殊处理, 具有高抗腐蚀性。

“Take it easy”易寻系统: 通过色彩标签找到匹配的尺寸。

- 特别适用于狭小空间。
- 特殊几何形状增加了工具的接触面
- 扳手开口的小回转角让所有螺丝在15°内完成适配
- 倾斜度为15°的狭长环形扳头
- “易寻”色标系统: 用特定的颜色代表不同端头种类和尺寸

6003 Joker 组合扳手



Code	EAN								
05020190001	219039		5,5	105	16	4	10	3	
05020198001	218780		6	105	16	4	10	3	
05020199001	218773		7	110	17,7	4,2	11,5	3	
05020200001	212528		8	115	19	4,5	12,5	3	
05020219001	220097		9	120	21	4,8	13,5	3	
05020201001	212542		10	125	22	5	15	3	
05020202001	212559		11	135	24,5	5	17	3	
05020203001	212566		12	148	26	5,5	18	3	
05020204001	212696		13	160	27	6	19	3	
05020205001	212702		14	167	29	6	20	3	
05020206001	212719		15	174	32	6	22	3	
05020207001	212726		16	182	35	6,5	23	3	
05020208001	212733		17	190	38	6,5	24,5	3	
05020209001	212740		18	210	39	7,5	26	3	
05020210001	212757		19	230	42	7,5	27,5	3	
05020500001	218797		20	230	45	7,5	29	3	
05020501001	218803		21	260	47	7,5	30	3	
05020502001	218841		22	260	49	7,5	31,5	3	
05020503001	218858		24	280	53	8	36	3	
05020504001	218865		27	300	60	8,5	40	3	
05020505001	218872		30	330	66	9	43	3	
05020506001	218889		32	360	70	9,5	45,5	3	
05020507001	218896		36	460	80	10	50,5	3	

6003 Joker 组合扳手 · 英制

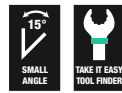

Code	EAN								
05020220001	219046		1/4"	105	16	4	10	3	
05020211001	212979		5/16"	115	19	4,5	12,5	3	
05020212001	212986		3/8"	125	22	5	15	3	
05020213001	212993		7/16"	135	24,5	5	17	3	
05020214001	213006		1/2"	160	26	6	19	3	
05020215001	213013		9/16"	167	29	6	20	3	
05020216001	213020		5/8"	182	35	6,5	23	3	
05020217001	213037		11/16"	210	40	7,5	26	3	
05020218001	213044		3/4"	230	42	7,5	27,5	3	

6003 Joker Pedal 单环开口扳手

超薄脚踏扳手6003 Joker Pedal 是狭窄空间作业的理想选择。

- 特别适用于狭小空间。
- 特殊几何形状增加了工具的接触面
- 扳手开口的小回转角让所有螺丝在15°内完成适配
- 倾斜度为15°的狭长环形扳头
- Joker 6003 踏板尺寸 15, 薄边口, 以安装并拆卸踏板
- 带“易寻”色标系统, 可轻松找到所需套筒。

6003 Joker Pedal 单环开口扳手



Code	EAN	mm	mm	mm	mm	mm	
05020221001	220677	15	174	32	4,5	22	1

6003 Joker 22 套装 1 单环开口扳手组套

随着在旋拧过程中安装空间变得越来越狭小, 即使在这种情况下, 也需要工具使用户能够顺利完成工作。

狭窄的空间需要额外的工具放置点。是否可以改造扳手, 以增加放置工具的可能性? 7.5° 旋转口和双六角几何结构的组合可以使放置点的数量加倍。

在旋拧过程中, 扳手在纵轴上重复转动 180°, 可以提供四种放置方式, 螺栓或螺钉头可以每 15° 接合一次。

Joker 6003 及其智能开口几何结构大大扩展了在密闭空间的使用范围。

Joker 6003 将在每次旋转后自动找到各自的放置点。细长而坚固的环侧与工具轴成 15°。高质量的表面处理实现高度持久的腐蚀防护。

带“易寻”色标系统: 按尺寸进行的颜色编码。

Joker 工具袋在背侧设有弯钩和环扣系统, 适合安装到墙壁、柜子、车间用滚轮小车和维拉 2go 系统。

- 22 件单环开口扳手组套 - 特别适合狭窄空间内的安装
- 特殊几何形状增加了工具的接触面
- 扳手开口的小回转角让所有螺丝在15°内完成适配
- 倾斜度为15°的狭长环形扳头

6003 Joker 22 套装 1 单环开口扳手组套

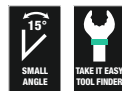

Code	EAN		
05020232001	221087		1
		6003 Joker 1x 5,5x105; 1x 6x105; 1x 7x110; 1x 8x115; 1x 9x120; 1x 10x125; 1x 11x135; 1x 12x148; 1x 13x160; 1x 14x167; 1x 15x174; 1x 16x182; 1x 17x190; 1x 18x210; 1x 19x230; 1x 20x230; 1x 21x260; 1x 22x260; 1x 24x280; 1x 27x300; 1x 30x330; 1x 32x360	

6003 Joker 6003扳手组套15件

- 坚固的帆布腰包装

6003 Joker 6003扳手组套15件



Code	EAN		
05020302001	222657		1
		6003 Joker 1x 5,5x105; 1x 6x105; 1x 7x110; 1x 8x115; 1x 9x120; 1x 10x125; 1x 11x135; 1x 12x148; 1x 13x160; 1x 14x167; 1x 15x174; 1x 16x182; 1x 17x190; 1x 18x210; 1x 19x230	
		魔术贴 240 1x 50,0x240,0	

6003 Joker 11 套装 1 组合扳手套装

- 坚固的帆布腰包装

6003 Joker 11 套装 1 组合扳手套装

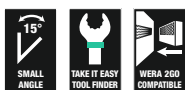

Code	EAN		
05020231001	214195		1
		6003 Joker 1x 8x115; 1x 10x125; 1x 11x135; 1x 12x148; 1x 13x160; 1x 14x167; 1x 15x174; 1x 16x182; 1x 17x190; 1x 18x210; 1x 19x230	
		魔术贴 240 1x 50,0x240,0	

6003 Joker 8 Imperial 套装 1 组合扳手套装 · 英制

- 坚固的帆布腰包装

6003 Joker 8 Imperial 套装 1 组合扳手套装 · 英制

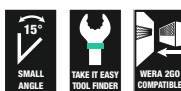

Code	EAN		
05020241001	214201		1
		6003 Joker Imperial 1x 5/16"x115; 1x 3/8"x125; 1x 7/16"x135; 1x 1/2"x160; 1x 9/16"x167; 1x 5/8"x182; 1x 11/16"x210; 1x 3/4"x230	
		魔术贴 240 1x 50,0x240,0	

6003 Joker 5 套装 1 组合扳手套装

- 坚固的帆布腰包装

6003 Joker 5 套装 1 组合扳手套装



Code	EAN		
05020230001	214171		1
		6003 Joker 1x 8x115; 1x 10x125; 1x 13x160; 1x 17x190; 1x 19x230	
		魔术贴 120 1x 50,0x120,0	

自行车组套 10

5 件 Joker 6003 单环开口扳手组套; 尺寸 15, 极细刀头设计。旋拧过程中, 作业空间变得越来越狭小, 即使在这种情况下, 也需要工具使用户能够顺利完成工作。

狭窄的空间需要额外的工具放置点。

是否可以改造扳手, 以增加放置工具的可能性? 7.5° 旋转口和双六角几何结构的组合可以使放置点的数量加倍。

在旋拧过程中, 扳手在纵轴上重复转动 180°, 可以提供四种放置方式, 螺栓或螺钉头可以每 15° 接合一次。

Joker 6003 及其智能开口几何结构大大扩展了在密闭空间的使用范围。

Joker 6003 将在每次旋转后自动找到各自的放置点。细长而坚固的环侧与工具轴成 15°。

高质量的表面处理实现高度持久的腐蚀防护。带“易寻”色标系统: 按尺寸进行的颜色编码。

Joker 工具袋在背侧设有弯钩和环扣系统, 适合安装到墙壁、柜子、车间用滚轮小车和维拉 2go 系统。

- 尤其适合狭窄空间的拧紧作业, 如摩托车
- 特殊几何形状增加了工具的接触面
- 扳手开口的小回转角让所有螺丝在 15° 内完成适配
- 倾斜度为 15° 的狭长环形扳头
- Joker 6003 踏板尺寸 15, 薄边口, 以安装并拆卸踏板

自行车组套 10



Code		EAN		
05004178001		4013288 220653		1
		6003 Joker		
		1x 8x115; 1x 9x120; 1x 10x125; 1x 13x160		
		6003 Joker Pedal 单环开口扳手		
		1x 15x174		
		魔术贴 120		
		1x 50,0x120,0		

自行车组套 12

12 件 Joker 6003 单环开口扳手组套; 尺寸 15, 极细刀头设计。旋拧过程中, 作业空间变得越来越狭小, 即使在这种情况下, 也需要工具使用户能够顺利完成工作。

狭窄的空间需要额外的工具放置点。是否可以改造扳手, 以增加放置工具的可能性?

7.5° 旋转口和双六角几何结构的组合可以使放置点的数量加倍。在旋拧过程中, 扳手在纵轴上重复转动 180°, 可以提供四种放置方式, 螺栓或螺钉头可以每 15° 接合一次。

Joker 6003 及其智能开口几何结构大大扩展了在密闭空间的使用范围。

Joker 6003 将在每次旋转后自动找到各自的放置点。细长而坚固的环侧与工具轴成 15°。

高质量的表面处理实现高度持久的腐蚀防护。

带“易寻”色标系统: 按尺寸进行的颜色编码。

Joker 工具袋在背侧设有弯钩和环扣系统, 适合安装到墙壁、柜子、车间用滚轮小车和维拉 2go 系统。

- 特别适用于狭小空间
- 特殊几何形状增加了工具的接触面
- 扳手开口的小回转角让所有螺丝在 15° 内完成适配
- 倾斜度为 15° 的狭长环形扳头
- Joker 6003 踏板尺寸 15, 薄边口, 以安装并拆卸踏板
- 带“易寻”色标系统, 可轻松找到所需套筒
- 坚固的帆布腰包

自行车组套 12



Code		EAN		
05004181001		4013288 220721		1
		6003 Joker		
		1x 6x105; 1x 7x110; 1x 8x115; 1x 9x120; 1x 10x125; 1x 11x135; 1x 12x148; 1x 13x160; 1x 14x167; 1x 16x182; 1x 17x190		
		6003 Joker Pedal		
		1x 15x174		

6003 Joker 5 Imperial 套装1 组合扳手套装 · 英制

- 坚固的帆布腰包装

6003 Joker 5 Imperial 套装1 组合扳手套装 · 英制



Code	EAN		
05020240001	214188		1
		6003 Joker Imperial 1x 9/16"x115; 1x 7/8"x125; 1x 1/2"x160; 1x 9/16"x167; 1x 3/4"x230	
		魔术贴 120 1x 50,0x120,0	

6003 Joker 4 Set 1 梅花扳手套组

随着在旋拧过程中安装空间变得越来越狭小,即使在这种情况下,也需要工具使用户能够顺利完成工作。

狭窄的空间需要额外的工具放置点。

是否可以改造扳手,以增加放置工具的可能性? 7.5° 旋转口和双六角几何结构的组合可以使放置点的数量加倍。

在旋拧过程中,扳手在纵轴上重复转动 180°,可以提供四种放置方式,螺栓或螺丝头的回转角度为 15°。

Joker 6003 及其智能开口几何结构大大扩展了在密闭空间的使用范围。

Joker 6003 将在每次旋转后自动找到各自的放置点。细长而坚固的环侧与工具轴成 15°。

高质量的表面处理实现高度持久的腐蚀防护。

配Take it easy易寻色标系统:用特定颜色代表不同尺寸。工具架的耐磨材料保证可轻松拆卸和牢牢握住扳手。

- Joker 环形扳手, 付新型收纳夹和随身包

6003 Joker 4 Set 1 梅花扳手套组

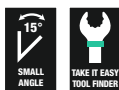

Code	EAN		
05020228001	225665		1
		6003 Joker 1x 8x115; 1x 10x125; 1x 12x148; 1x 13x160	



6003 Joker 4 组套公制 1 梅花扳手组套

- Joker 环形扳手, 付新型收纳夹和随身包

6003 Joker 4 组套公制 1 梅花扳手组套

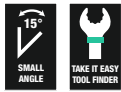

Code	EAN		
05020229001	4013288 225672		1
		6003 Joker Imperial 1x 9/16"x115; 1x 3/8"x125; 1x 7/16"x135; 1x 1/2"x160	

9640 磁性条带 6003 Joker 1 环形扳手组套

- 11 件组套<
- 凭借其强大的磁性, 该条可以牢牢地吸附在金属表面。条带也可以用螺栓固定在墙上
- 条形端头完全固定住工具

9640 磁性条带 6003 Joker 1 环形扳手组套



Code	EAN		
05020233001	4013288 228963		1
		6003 Joker 1x 8x115; 1x 10x125; 1x 11x135; 1x 12x148; 1x 13x160; 1x 14x167; 1x 15x174; 1x 16x182; 1x 17x190; 1x 18x210; 1x 19x230,0	
		9610 1x 30,0x370,0	

9641 磁性条带 6003 Joker 2 梅花扳手组套

- 5 件组套

9641 磁性条带 6003 Joker 2 梅花扳手组套

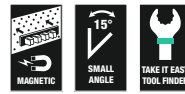

Code	EAN		
05020234001	4013288 229854		1
		6003 Joker 1x 8x115; 1x 10x125; 1x 13x160; 1x 17x190; 1x 19x230,0	
		9610 1x 30,0x370,0	

9642 磁性条带 6003 Joker Imperial 1 环形扳手组套

- 英制
- 8 件组套

9642 磁性条带 6003 Joker Imperial 1 环形扳手组套

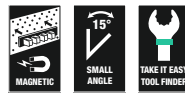

Code	EAN		
05020235001	4013288 229878		1
		6003 Joker Imperial 1x 9/16"x115; 1x 3/8"x125; 1x 7/16"x135; 1x 1/2"x160; 1x 9/16"x167; 1x 5/8"x182; 1x 11/16"x210; 1x 3/4"x230,0	
		9610 1x 30,0x370,0	

6004 Joker 自调式开口扳手

用户们都渴望拥有一个应用广泛且便于携带使用的紧固工具。它同时使用于英制和公制。能根据不同螺栓螺帽尺寸自动调节开口大小。

安全操作无危险, 作业效率有保障。光滑的平行双顎口能取代尺寸不一的各类开口扳手。

安装六角螺帽或螺栓时, 所需尺寸可自动校准。

内置的杠杆结构让六角螺栓或螺帽紧固在顎口上, 显著降低了打滑或者损坏的危险。内置的棘轮功能更保障了紧固过程快速和流畅, 不会产生任何滞顿。

顎口的凹槽设计, 使其回转角仅为30°。借助棘轮功能和顎口凹槽, 单臂设计让扳手进入狭小空间。

自调式Joker 6004是一个名副其实的通用紧固工具。自动调节。牢固夹持。深入吻合。

- 自调式Joker 6004能取代不同尺寸的开口扳手 (公制和英制)
- 自动无阻碍地夹紧六角螺栓和螺帽
- 避免在夹紧过程中产生打滑和损坏的杠杆机构
- 借助杠杆棘轮功能, 无需取下扳手便可快速流畅完成螺丝紧固工序
- 开口凹槽设计实现 30° 回转角

6004 Joker XS 自调式棘轮开口扳手



		EAN						
Code	4013288		mm		mm	mm		
05020099001	216892		7-10	1/4"-3/8"	117	7,7		3

6004 Joker S 自调式开口扳手



		EAN						
Code	4013288		mm		mm	mm		
05020100001	211729		10-13	7/16"-1/2"	154	10		3

6004 Joker M 自调式棘轮开口扳手



		EAN						
Code	4013288		mm		mm	mm		
05020103001	216908		13-16	1/2"-5/8"	188	12,4		3

6004 Joker L 自调式开口扳手



	EAN						
Code	4013288	mm		mm	mm		
05020101001	214706	16-19	5/8"-3/4"	224	14		3

6004 Joker XL 自调式开口扳手



	EAN						
Code	4013288	mm		mm	mm		
05020104001	216915	19-24	3/4"-15/16"	256	16		2

6004 Joker XXL 自调式开口扳手



	EAN						
Code	4013288	mm		mm	mm		
05020102001	214713	24-32	15/16"-1 1/4"	322	20		3

6004 Joker 4 自调式棘轮开口扳手套装 1

- 内含4把可调节Joker 6004扳手的紧凑型折叠工具袋, 涵盖了7至19mm或 1/4"英寸至3/4"英寸的所有公制和英制尺寸的应用

6004 Joker 4 自调式棘轮开口扳手套装 1



	EAN		
Code	4013288		
05020110001	217516		1
		6004 Joker XS 1x 7-10 (1/4"-3/8")x117	
		6004 Joker S 1x 10-13 (7/16"-1/2")x154	
		6004 Joker M 1x 13-16 (1/2"-5/8")x188	
		6004 Joker L 1x 16-19 (5/8"-3/4")x224	

6005 Joker 双开口扳手

- 两端开口扳手
- 特别适用于狭小空间
- 特殊几何形状增加了工具的接触面
- 扳手开口的小回转角让所有螺丝在15°内完成适配
- 带“易寻”色标系统,可轻松找到所需套筒

6005 Joker 双开口扳手



Code	EAN							
Code	EAN		mm	mm	mm	mm	mm	
05020310001	4013288		6	16	7	17,7	4	3
05020311001	224873		8	19	9	21	4,5	3
05020312001	224880		10	23	11	25	5	3
05020313001	224897		12	26	13	27	5,5	3

6005 Joker 4 组套 1 双开口扳手组套

- Joker环形扳手, 付新型收纳夹和随身包

6005 Joker 4 组套 1 双开口扳手组套

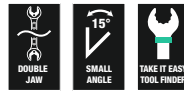

Code	EAN		
05020314001	4013288	224750	1
6005 Joker 双开口 1x 6x7x111,8; 1x 8x9x122,2; 1x 10x11x137,3; 1x 12x13x166			

9610 Joker 磁性条带 · 最多可用于 11 个扳手 · 空袋

- 凭借其强大的磁性,该条可以牢牢地吸附在金属表面。条带也可以用螺栓固定在墙上
- 条形端头完全固定住工具

9610 Joker 磁性条带 · 最多可用于 11 个扳手 · 空袋

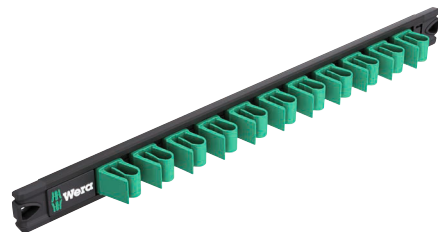

Code	EAN							
Code	EAN	mm	mm					
05136413001	228956	30,0	370,0					1





L 型扳手

增强型内六角- 专门针对六角型螺丝的设计

如图可看到和螺槽的接触面积大幅度的增加 因此减少了

从而避免破坏螺丝凹槽的轮廓

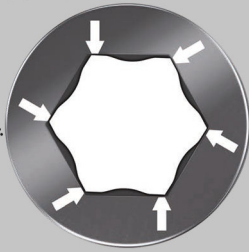

Kraftform 不锈钢系列 – 避免生锈

维拉的不锈钢工具通过真空冰处理以达到所需硬度和强度，可满足工业级别的应用。

不锈钢材质避免外因锈蚀形成

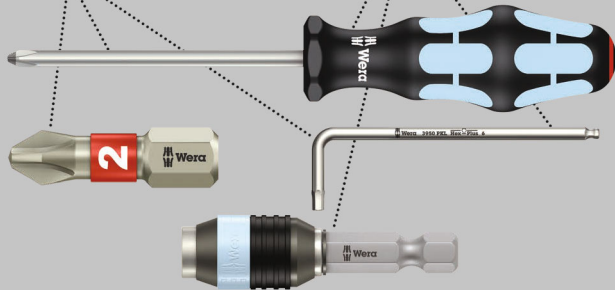

不锈钢L型扳手经过特殊硬化，达到与普通碳素钢工具相同的硬度，并且可以防止锈蚀产生。内六角螺丝存在一个问题，由于从扳头传递外力到螺丝的接触面很窄，导致螺丝头可能会损坏，通常是凹处被磨圆。Hex-Plus工具有较大的接触面，可防止这种损坏。它从凹槽的平面处驱动螺丝，而不是从角面，因此和一般L型扳手相比增加了20%可以被传递的扭矩。

并且Hex-Plus工具适合每一个标准内六角螺丝!球头可带角度作业。用特定的颜色代表不同花形，再辅以简洁的尺寸标示，让寻找工具变得简单快速。带“易寻”色标系统的工具包括：用于驱动内六角螺丝的工具（L型扳手、Zyklop旋具套筒）、用于驱动外六角螺丝的工具（Joker扳手、带固持功能的Zyklop套筒和Zyklop旋具套筒）、以及用于驱动TORX®梅花螺丝的工具（L型扳手、Zyklop旋具套筒）。

- 生锈问题的解决方案：使用不锈钢工具拆装不锈钢螺丝
- Hex-Plus六角增强型可延长螺丝头的寿命
- “易寻”色标系统：用特定的颜色代表不同端头种类和尺寸
- 防磨工具夹，延长使用寿命
- 带颜色识别标识，易于握持的塑料护套可抵御低温

3950/9 Hex-Plus 彩色 HF 不锈钢 1 L 型扳手组套 · 公制 · 不锈钢 · 带固持功能

- 自 3.0 尺寸起，长臂上的固持功能可使螺丝稳固固定在工具上

3950/9 Hex-Plus 彩色 HF 不锈钢 1 L 型扳手组套 · 公制 · 不锈钢 · 带固持功能



Code	EAN		
	4013288		
05022699001	224477		1
		<ul style="list-style-type: none"> 3950 SPKL Multicolour 1x 1,5x90; 1x 2,0x101; 1x 2,5x112 3950 SPKL 彩色 HF 1x 3,0x123; 1x 4,0x137; 1x 5,0x154; 1x 6,0x172; 1x 8,0x195; 1x 10,0x224 	

3950/9 Hex-Plus Multicolour Stainless 1 不锈钢公制内六角扳手组套



Code	EAN		
	4013288		
05022669001	185211		1
		<ul style="list-style-type: none"> 3950 SPKL Renkli 1x 1,5x90; 1x 2,0x101; 1x 2,5x112; 1x 3,0x123; 1x 4,0x137; 1x 5,0x154; 1x 6,0x172; 1x 8,0x195; 1x 10,0x224 	

3950/9 Hex-Plus Stainless 1 不锈钢公制球头内六角 L 型扳手组套

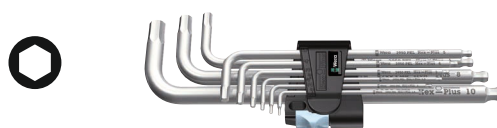

Code	EAN		
	4013288		
05022720001	111364		10
		<ul style="list-style-type: none"> 3950 PKL 1x 1,5x90; 1x 2,0x101; 1x 2,5x112; 1x 3,0x123; 1x 4,0x137; 1x 5,0x154; 1x 6,0x172; 1x 8,0x195; 1x 10,0x224 	

3950/9 Hex-Plus Stainless 1 不锈钢公制球头内六角 L 型扳卡组套吊卡装

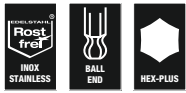

Code	EAN		
05073544001	180377	○	3950 PKL 1x 1,5x90; 1x 2,0x101; 1x 2,5x112; 1x 3,0x123; 1x 4,0x137; 1x 5,0x154; 1x 6,0x172; 1x 8,0x195; 1x 10,0x224

3950/9 Hex-Plus Imperial Stainless 1 不锈钢 L 型扳卡组套 · 英制

- 坚固的帆布腰包装

3950/9 Hex-Plus Imperial Stainless 1 不锈钢 L 型扳卡组套 · 英制



Code	EAN		
05022721001	117281	○	3950 PKL inch 1x 3/32"x112; 1x 7/64"x119; 1x 1/8"x123; 1x 9/64"x130; 1x 5/32"x137; 1x 3/16"x154; 1x 1/4"x185; 1x 5/16"x195; 1x 3/8"x224

950/9 Hex-Plus Multicolour HF 1 公制内六角 L 型扳卡组套 · 彩色 · 激光表面处理 · 带固持功能 · 公

- L型内六角扳手附固持功能
- 长臂带六角形球头
- 带颜色识别标识, 易于握持的塑料护套可抵御低温

950/9 Hex-Plus Multicolour HF 1 公制内六角 L 型扳卡组套 · 彩色 · 激光表面处理 · 带固持功能 · 公



Code	EAN		
05022210001	188403	○	950 SPKL Multicolour 1x 1,5x90; 1x 2,0x101; 1x 2,5x112
		○	950 SPKL HF Multicolour 1x 3,0x123; 1x 4,0x137; 1x 5,0x154; 1x 6,0x172; 1x 8,0x195; 1x 10,0x224

950/9 Hex-Plus Multicolour 1 内六角 L 型扳卡组套 · 彩色 · 激光表面处理



Code	EAN		
05022089001	180841	○	950 SPKL Multicolour 1x 1,5x90; 1x 2,0x101; 1x 2,5x112; 1x 3,0x123; 1x 4,0x137; 1x 5,0x154; 1x 6,0x172; 1x 8,0x195; 1x 10,0x224

950/9 Hex-Plus Multicolour 1 公制内六角 L 型扳手组套吊卡装 · 彩色 · 激光表面处理



Code		EAN	950 SPKL Multicolour 1x 1.5x90; 1x 2.0x101; 1x 2.5x112; 1x 3.0x123; 1x 4.0x137; 1x 5.0x154; 1x 6.0x172; 1x 8.0x195; 1x 10.0x224	1
05073593001		165688		

L型扳手和两段式置放夹

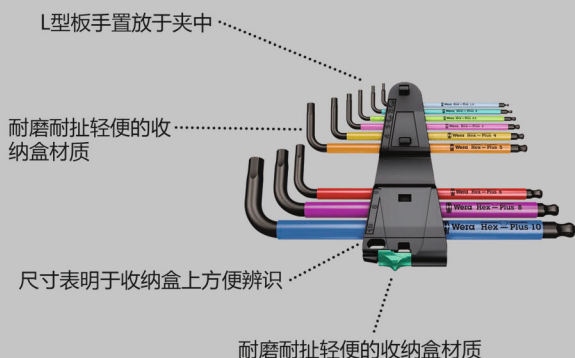

950/9 Hex-Plus Multicolour 2 内六角 L 型扳手组套 · 彩色 · 激光表面处理

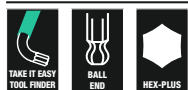

Code		EAN	950 SPKS Multicolour 1x 1,5x50; 1x 2,0x56; 1x 2,5x63; 1x 3,0x71; 1x 4,0x80; 1x 5,0x90; 1x 6,0x100; 1x 8,0x112; 1x 10,0x125	1
05133164001		207517		

950/9 Hex-Plus 多色 3 L 型扳手组套 · 公制 · BlackLaser

9 个 L 型扳手, 带塑料套筒 (SPKL), 由圆形可夹持材料制成。套筒即使在低温下也能提高操作舒适度, 而且可以释放手指。

L 型扳手具有颜色编码和尺寸标记, 可以很容易找到。方便地存放在 9109 支架内, 这样可以将其竖在桌面上或悬挂在墙壁上。

集成在机架中的 9539 夹子可拆卸, 以便移动使用。最重要的是, 该支架配置有智能化可拆卸 9538 着磁装置, 该装置可用于磁化 (和消磁) 螺丝和刀头; 这样便不必再用另一只手抓住螺丝。

- 支架可安放在桌面上或者悬挂在墙壁上
- 集成式夹子, 可拆卸以方便移动使用
- 用于磁化和去磁化工具尖端的可移除磁体
- L型扳手, 用于内六角螺丝
- Hex-Plus六角增强型可延长螺丝头的寿命
- 橡胶护套, 抓握舒适
- 长臂带六角形球头
- 激光发黑表面处理, 具有抗腐蚀性和较长的使用寿命

950/9 Hex-Plus 多色 3 L 型扳手组套 · 公制 · BlackLaser



Code		EAN	950 SPKL Multicolour 1x 1,5x90; 1x 2,0x101; 1x 2,5x112; 1x 3,0x123; 1x 4,0x137; 1x 5,0x154; 1x 6,0x172; 1x 8,0x195; 1x 10,0x224	1
05133165001		230294		
		9539		
		9109		
		9538		

3950/9 增强型内六角 彩色英制不锈钢 1 SB · 不锈钢

维拉 优质不锈钢内六角扳手组套，用于英制内六角螺丝。不锈钢防止形成外部锈蚀。

增强型六角 提高了与螺丝的接触面。

将冲孔效应降至最低，几乎消除了破坏螺丝风险。

含长臂杆和六角球头：球头使刀杆能够移动，并相对于螺旋轴旋转，让拧紧作业“刚好完成”。

“易寻”色标系统，用特定颜色代表不同刀头尺寸。

装入耐磨内六角扳手工具夹。

3950/9 增强型内六角 彩色英制不锈钢 1 SB · 不锈钢



Code	EAN			
05022860001	4013288 221360			1
			3950 SPKL Multicolour Imperial 1x 5/64"x101; 1x 3/32"x112; 1x 1/8"x123; 1x 5/32"x137; 1x 3/16"x154; 1x 7/32"x172; 1x 1/4"x185; 1x 5/16"x195; 1x 3/8"x224	

950/9 Hex-Plus Multicolour Imperial 1 内六角 L 型扳手组套 · 彩色 · 激光表面处理 · 英制

- 坚固的帆布腰包装

950/9 Hex-Plus Multicolour Imperial 1 内六角 L 型扳手组套 · 彩色 · 激光表面处理 · 英制



Code	EAN			
05022639001	4013288 182593			1
			950 SPKL inch 1x 5/64"x101; 1x 3/32"x112; 1x 1/8"x123; 1x 5/32"x137; 1x 3/16"x154; 1x 7/32"x172; 1x 1/4"x185; 1x 5/16"x195; 1x 3/8"x224	

950/9 Hex-Plus 彩色英制 2 L 型六角扳手套装 · 英制 · BlackLaser



Code	EAN			
05022640001	4013288 219107			1
			950 SPKL inch 1x 5/64"x101; 1x 3/32"x112; 1x 1/8"x123; 1x 5/32"x137; 1x 3/16"x154; 1x 7/32"x172; 1x 1/4"x185; 1x 5/16"x195; 1x 3/8"x224	

950/9 Hex-Plus 多色 3 L 型扳手套装 · 英制 · BlackLaser

- 英制

950/9 Hex-Plus 多色 3 L 型扳手套装 · 英制 · BlackLaser



Code	EAN			
05022641001	4013288 230188			1
			950 SPKS Multicolour · 英制 1x 5/64"x50; 1x 3/32"x56; 1x 1/8"x63; 1x 5/32"x71; 1x 3/16"x80; 1x 7/32"x90; 1x 1/4"x100; 1x 5/16"x112; 1x 3/8"x125	



950/7 Hex-Plus Multicolour Magnet 1 公制内六角 L 型扳手套组 · 彩色 · 激光表面处理

- 使用嵌入式螺丝最明显的好处是可以通过磁力使其附着在扳手上。带充磁器/消磁器的维拉收纳夹可以使 L 型扳手快速磁化或消磁。

950/7 Hex-Plus Multicolour Magnet 1 公制内六角 L 型扳手套组 · 彩色 · 激光表面处理



Code	EAN		
05022534001	183750		5
		950 SPKL Multicolour 1x 1,5x90; 1x 2,0x101; 1x 2,5x112; 1x 3,0x123; 1x 4,0x137; 1x 5,0x154; 1x 6,0x172	

950/9 L Hex-Plus HF 1 公制内六角 L 型扳手套组 · 彩色 · 镀铬 表面处理 · 带固持功能

- 固持功能确保螺丝牢固黏着在工具上
- 镀铬, 具有高抗腐蚀性

950/9 L Hex-Plus HF 1 公制内六角 L 型扳手套组 · 彩色 · 镀铬 表面处理 · 带固持功能



Code	EAN		
05022130001	207227		1
		950 L 1x 1,5x90 ¹⁾ ; 1x 2,0x100; 1x 2,5x112	
		950 L HF 1x 3,0x126; 1x 4,0x140; 1x 5,0x160; 1x 6,0x180; 1x 8,0x200; 1x 10,0x219	

¹⁾ 正六边形

950/9 Hex-Plus 1 内六角 L 型扳手套组 · 公制 · 镀铬

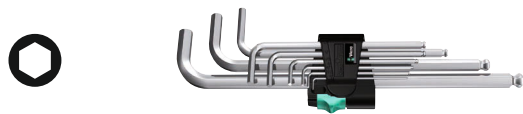

Code	EAN		
05022087001	104816		10
		950 PKL 1x 1,5x90 ¹⁾ ; 1x 2,0x100; 1x 2,5x112; 1x 3,0x126; 1x 4,0x140; 1x 5,0x160; 1x 6,0x180; 1x 8,0x200; 1x 10,0x219	

¹⁾ 正六边形

950/9 Hex-Plus 1 SB 公制内六角 L 型扳手套组吊卡装 · 激光表面处理



Code	EAN		
05073391001	030160		1
		950 PKL 1x 1,5x90 ¹⁾ ; 1x 2,0x100; 1x 2,5x112; 1x 3,0x126; 1x 4,0x140; 1x 5,0x160; 1x 6,0x180; 1x 8,0x200; 1x 10,0x219	

¹⁾ 正六边形

950/9 Hex-Plus 2 内六角 L 型扳手套组 · 公制 · 镀铬



Code	EAN		
05021909001	111937		10
		950 L 1x 1,5x90 ¹⁾ ; 1x 2,0x100; 1x 2,5x112; 1x 3,0x126; 1x 4,0x140; 1x 5,0x160; 1x 6,0x180; 1x 8,0x200; 1x 10,0x219	

¹⁾ 正六边形

950/9 Hex-Plus 3 内六角 L 型扳手组套 · 公制 · 镀铬

- 短款
- 长臂带六角形球头

950/9 Hex-Plus 3 内六角 L 型扳手组套 · 公制 · 镀铬



Code	EAN		
	4013288		
05133163001	112255		10
		○ 950 PKS 1x 1,5x50 ¹⁾ ; 1x 2,0x56; 1x 2,5x63; 1x 3,0x71; 1x 4,0x80; 1x 5,0x90; 1x 6,0x100; 1x 8,0x112; 1x 10,0x125	

¹⁾ 正六边形

950/9 Hex-Plus 4 内六角 L 型扳手组套 · 公制 · 镀铬

- 超短臂用于处理狭小空间内的螺丝
- 长臂带六角形球头

950/9 Hex-Plus 4 内六角 L 型扳手组套 · 公制 · 镀铬



Code	EAN		
	4013288		
05073594001	139177		1
		○ 950 PKLS 1x 1,5x90 ¹⁾ ; 1x 2,0x100; 1x 2,5x112; 1x 3,0x126; 1x 4,0x140; 1x 5,0x160; 1x 6,0x180; 1x 8,0x200; 1x 10,0x219	

¹⁾ 正六边形

950/9 Hex-Plus 5 公制内六角 L 型扳手组套 · 镀铬



Code	EAN		
	4013288		
05021406001	111890		10
		○ 950 1x 1,5x45 ¹⁾ ; 1x 2,0x50; 1x 2,5x56; 1x 3,0x63; 1x 4,0x70; 1x 5,0x80; 1x 6,0x90; 1x 8,0x100; 1x 10,0x112	

¹⁾ 正六边形

950/9 Hex-Plus 6 内六角 L 型扳手组套 · 公制 · 激光表面处理

- 激光发黑表面处理, 具有抗腐蚀性和较长的使用寿命

950/9 Hex-Plus 6 内六角 L 型扳手组套 · 公制 · 激光表面处理



Code	EAN		
	4013288		
05022086001	104809		10
		○ 950 PKL BM 1x 1,5x90 ¹⁾ ; 1x 2,0x100; 1x 2,5x112; 1x 3,0x126; 1x 4,0x140; 1x 5,0x160; 1x 6,0x180; 1x 8,0x200; 1x 10,0x219	

¹⁾ 正六边形

950/9 Hex-Plus 6 内六角 L 型扳手组套吊卡装 · 公制 · 激光表面处理



Code	EAN		
	4013288		
05073596001	106414		1
		○ 950 PKL BM 1x 1,5x90 ¹⁾ ; 1x 2,0x100; 1x 2,5x112; 1x 3,0x126; 1x 4,0x140; 1x 5,0x160; 1x 6,0x180; 1x 8,0x200; 1x 10,0x219	

¹⁾ 正六边形

950/9 Hex-Plus 7 内六角 L 型扳手组套 · 公制 · 激光表面处理

- 短款

950/9 Hex-Plus 7 内六角 L 型扳手组套 · 公制 · 激光表面处理



Code	EAN		
	4013288		
05021737001	112286		10
		○ 950 BM 1x 1,5x45 ¹⁾ ; 1x 2,0x50; 1x 2,5x56; 1x 3,0x63; 1x 4,0x70; 1x 5,0x80; 1x 6,0x90; 1x 8,0x100; 1x 10,0x112	

¹⁾ 正六边形



950/9 Hex-Plus 8 L 型扳手组套 · 公制 · 镀铬

9 个镀铬 L 型扳手, 其 Hex-Plus 特征能够防止圆形螺丝转动, 因此它是适用于内六角螺丝的强大工具组套。

方便地存放在支架内, 这样可以将其竖在桌面上或悬挂在墙壁上。集成式夹子, 可拆卸以方便移动使用。

最重要的是, 该支架配置有智能化可拆卸磁装置, 该装置可用于磁化 (和消磁) 螺丝和刀头; 这样便不必再用另一只手抓住螺丝。

- 支架可安放在桌面上或者悬挂在墙壁上
- 集成式夹子, 可拆卸以方便移动使用
- 用于磁化和去磁化工具尖端的可移除磁体

950/9 Hex-Plus 8 L 型扳手组套 · 公制 · 镀铬



Code	EAN		
05022102001	4013288 230171		1
		 950 PKL 1x 1,5x90 ¹⁾ ; 1x 2,0x100; 1x 2,5x112; 1x 3,0x126; 1x 4,0x140; 1x 5,0x160; 1x 6,0x180; 1x 8,0x200; 1x 10,0x219	
		9109	
		9536	
		9538	

¹⁾ 正六边形

950/7 Hex-Plus Magnet 1 公制内六角 L 型扳手组套 · 镀铬 · 带磁性

- 使用嵌入式螺丝最明显的好处是可以通过磁力使其附着在扳手上。带充磁器/消磁器的维拉收纳夹可以使 L 型扳手快速磁化或消磁。

950/7 Hex-Plus Magnet 1 公制内六角 L 型扳手组套 · 镀铬 · 带磁性



Code	EAN		
05022101001	4013288 111968		10
		 950 PKL 1x 1,5x90 ¹⁾ ; 1x 2,0x100; 1x 2,5x112; 1x 3,0x126; 1x 4,0x140; 1x 5,0x160; 1x 6,0x180	

¹⁾ 正六边形

950/7 Hex-Plus 1 公制内六角 L 型扳手组套 · 镀铬

- 长臂带六角形球头

950/7 Hex-Plus 1 公制内六角 L 型扳手组套 · 镀铬



Code	EAN		
05022181001	4013288 111883		10
		 950 PKL 1x 1,5x90 ¹⁾ ; 1x 2,0x100; 1x 2,5x112; 1x 3,0x126; 1x 4,0x140; 1x 5,0x160; 1x 6,0x180	

¹⁾ 正六边形

950/13 Hex-Plus Imperial 1 内六角 L 型扳手组套 · 英制 · 激光表面处理

- 激光发黑表面处理, 具有抗腐蚀性和较长的使用寿命
- 长臂带六角形球头

950/13 Hex-Plus Imperial 1 内六角 L 型扳手组套 · 英制 · 激光表面处理

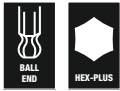

Code	EAN		
	4013288		
05021728001	111982		10
		○ 950 PKL inch 1x 0,05"x83 ¹⁾ ; 1x 1/16"x91 ¹⁾ ; 1x 5/64"x100; 1x 3/32"x112; 1x 7/64"x119; 1x 1/8"x126; 1x 9/64"x132; 1x 5/32"x140; 1x 3/16"x160; 1x 7/32"x180; 1x 1/4"x190; 1x 5/16"x200; 1x 3/8"x212	
¹⁾ 正六边形			

950/13 增强型内六角 英制 1 SB 内六角扳手组套 · 英制 · 激光发黑表面处理

优质不锈钢内六角扳手组套, 用于英制内六角螺丝, 配合实用耐磨材料制成的工具夹, 永久安全固定内六角扳手同时可轻松查找。

内六角扳手配 增强型六角 表面, 提高了与螺丝的接触面。将冲孔效应降至最低, 几乎消除了破坏螺丝风险。

加长臂杆的球锁即使在复杂安装条件下也能实现安全作业。

激光发黑表面处理, 提供额外表面保护, 具有抗腐蚀性和较长的使用寿命。

激光发黑表面处理, 内六角扳手上含耐磨尺寸标识, 可快速查找。

950/13 增强型内六角 英制 1 SB 内六角扳手组套 · 英制 · 激光发黑表面处理



Code	EAN		
	4013288		
05021721001	221315	○ 950 PKL Emperyal 1x 0.05"x83 ¹⁾ ; 1x 1/16"x91 ¹⁾ ; 1x 5/64"x100; 1x 3/32"x112; 1x 7/64"x119; 1x 1/8"x126; 1x 9/64"x132; 1x 5/32"x140; 1x 3/16"x160; 1x 7/32"x180; 1x 1/4"x190; 1x 5/16"x200; 1x 3/8"x212	1
¹⁾ 正六边形			



950/9 Hex-Plus Imperial 1 内六角 L 型扳手套组 · 英制 · 激光表面处理

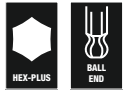

Code	EAN		
05022171001	4013288 111975		10
		 950 PKL inch 1x 5/64"x100; 1x 3/32"x112; 1x 1/8"x126; 1x 5/32"x140; 1x 3/16"x160; 1x 7/32"x180; 1x 1/4"x190; 1x 5/16"x200; 1x 3/8"x212	

950/9 Hex-Plus Imperial 1 SB 内六角 L 型扳手套组吊卡装 · 英制 · 激光表面处理



Code	EAN		
05133180001	4013288 154118	 950 PKL inch 1x 5/64"x100; 1x 3/32"x112; 1x 1/8"x126; 1x 5/32"x140; 1x 3/16"x160; 1x 7/32"x180; 1x 1/4"x190; 1x 5/16"x200; 1x 3/8"x212	1

自行车组件4



采用带塑料套管的环形材料制成的自行车专用L型扳手。即使在较低的温度条件下，塑料套管可提高操作舒适度，且手指操作轻松方便。

所有L型扳手采用颜色代码和尺寸标记，可轻松找到。六角套筒螺钉和TORX®螺钉采用质地牢固且重量轻的折叠袋。

- 设计实用、重量轻的折叠袋，携带方便

自行车组件4



Code	EAN		
05004173001	4013288 211446		1
		 950 SPKL Multicolour 1x 2,0x101; 1x 2,5x112	
		 950 SPKL HF Multicolour 1x 3,0x123; 1x 4,0x137; 1x 5,0x154; 1x 6,0x172; 1x 8,0x195	
		 967 SXL TORX® HF Multicolour 1x TX 10x112; 1x TX 25x154	
		自粘钩和环扣带 70 1x 50,0x70,0	

3950 SPKL 彩色 HF L 型扳手 · 公制 · 不锈钢 · 带固持功能

维拉 优质不锈钢内六角扳手组套, 用于六角套筒螺丝。不锈钢防止形成外部锈蚀。六角增强型 提高了与螺丝的接触面。将使用时造成的磨损降至最低, 几乎完全消除了破坏螺丝凹槽的风险。

六角球头位于长杆末端: 球头驱动意味着轴身可以绕着螺丝旋转, 因此可以在狭窄区域利用角度进行螺丝拆装。“易寻”色标系统: 用特定颜色代表不同端头尺寸。

- 生锈问题的解决方案: 使用不锈钢工具拆装不锈钢螺丝
- 不锈钢L型扳手, 可防止不锈钢螺丝的外因锈蚀
- Hex-Plus六角增强型可延长螺丝头的寿命
- 长臂杆带固持功能, 让螺丝能牢固附着在工具上
- 长臂上带有球头, 便于偏心使用
- 带“易寻”色标系统, 可轻松找到所需套筒
- 所有的L型扳手都有一个彩色编码, 易于抓握的软管套筒, 即使在低温下也符合人体工程学和舒适的操作
- 带“易寻”色标系统, 可轻松找到所需套筒

3950 SPKL 彩色 HF L 型扳手 · 公制 · 不锈钢 · 带固持功能



Code	EAN		⊙	L ₁	L ₂	L ₃	L ₄	📦
	4013288		mm	mm	mm			
05022693001	224415		3,0	123	21	4 7/8"	27/32"	10
05022694001	224422		4,0	137	24	5 3/8"	1"	10
05022695001	224439		5,0	154	27	6 1/16"	1 1/16"	10
05022696001	224446		6,0	172	31	6 3/4"	1 1/4"	10
05022697001	224453		8,0	195	37	7 11/16"	1 7/16"	10
05022698001	224460		10,0	224	42	9"	1 11/16"	10

3950 SPKL Multicolour 不锈钢内六角扳手 · 公制

不锈钢L型扳手经过特殊硬化, 达到与普通碳素钢工具相同的硬度, 并且可以防止锈蚀产生。维拉的不锈钢工具通过真空冰处理以达到所需硬度和强度, 可满足工业级别的应用。内六角螺丝存在一个问题, 由于从扳手头传递外力到螺丝的接触面很窄, 导致螺丝头可能会损坏, 通常是凹处被磨圆。

Hex-Plus工具有较大的接触面, 可防止这种损坏。它从凹槽的平面处驱动螺丝, 而不是从角面, 因此和一般L型扳手相比增加了20%可以被传递的扭矩。并且Hex-Plus工具适合每一个标准内六角螺丝!球头驱动意味着轴身可以绕着螺丝旋转, 因而可以在狭窄区域利用角度进行螺丝拆装。

用特定的颜色代表不同花形, 再辅以简洁的尺寸标示, 让寻找工具变得简单快速。

- 生锈问题的解决方案: 使用不锈钢工具拆装不锈钢螺丝
- Hex-Plus六角增强型可延长螺丝头的寿命
- 不锈钢L型扳手, 可防止不锈钢螺丝的外因锈蚀
- “易寻”色标系统: 用特定的颜色代表不同端头种类和尺寸
- 防磨工具夹, 延长使用寿命

3950 SPKL Multicolour 不锈钢内六角扳手 · 公制



	EAN		⊙	L ₁	L ₂	L ₃	L ₄	📦
Code	4013288		mm	mm	mm			
05022660001	185792		1,5	90	14	3 1/2"	9/16"	10
05022661001	185808		2,0	101	16	4"	5/8"	10
05022662001	185815		2,5	112	19	4 7/16"	3/4"	10
05022663001	185822		3,0	123	21	4 7/8"	27/32"	10
05022664001	185839		4,0	137	24	5 3/8"	1"	10
05022665001	185846		5,0	154	27	6 1/16"	1 1/16"	10
05022666001	185860		6,0	172	31	6 3/4"	1 1/4"	10
05022667001	185877		8,0	195	37	7 11/16"	1 7/16"	10
05022668001	185884		10,0	224	42	9"	1 11/16"	10

3950 SPKL 彩色内六角扳手 · 彩色 · 英制 · 不锈钢



	EAN		⊙	L	L	L	L	
Code	4013288		mm	mm				
05022850001	221384		5/64"	101	16	4"	5/8"	10
05022851001	221469		3/32"	112	19	4 7/16"	3/4"	10
05022852001	221452		1/8"	123	21	4 7/8"	53/64"	10
05022853001	221445		5/32"	137	24	5 3/8"	5/16"	10
05022854001	221438		3/16"	154	27	6 1/16"	1 1/16"	10
05022855001	221377		7/32"	172	31	6 3/4"	1 7/32"	10
05022856001	221421		1/4"	185	34	7 1/4"	1 11/32"	10
05022857001	221414		5/16"	195	37	7 11/16"	1 29/64"	10
05022858001	221407		3/8"	224	42	9"	1 21/32"	10

3950 PKL 不锈钢内六角 L 型扳手 · 公制



	EAN	⊙	L	L	L	L	
Code	4013288	mm	mm	mm			
05022700001	111265	1,5	90	14	3 1/2"	9/16"	10
05022701001	111272	2,0	101	16	4"	5/8"	10
05022702001	111289	2,5	112	19	4 7/16"	3/4"	10
05022703001	111296	3,0	123	21	4 7/8"	27/32"	10
05022704001	111302	4,0	137	24	5 3/8"	1"	10
05022705001	111319	5,0	154	27	6 1/16"	1 1/16"	10
05022706001	111326	6,0	172	31	6 3/4"	1 1/4"	10
05022708001	111340	8,0	195	37	7 11/16"	1 7/16"	10
05022709001	111357	10,0	224	42	9"	1 11/16"	10

3950 PKL 英制不锈钢内六角 L 型扳手



	EAN	⊙	L	L	L	L		
Code	4013288		mm	mm				
05022710001	117151		3/32"	112	19	4 7/16"	3/4"	10
05022711001	117168		7/64"	119	20	4 3/4"	25/32"	10
05022712001	117175		1/8"	123	21	4 7/8"	27/32"	10
05022713001	117182		9/64"	130	22	5 3/16"	29/32"	10
05022714001	117199		5/32"	137	24	5 3/8"	1"	10
05022715001	117205		3/16"	154	27	6 1/16"	1 1/16"	10
05022716001	117212		1/4"	185	34	7 1/4"	1 5/16"	10
05022717001	117229		5/16"	195	37	7 11/16"	1 7/16"	10
05022718001	117236		3/8"	224	42	9"	1 11/16"	5

950 SPKL HF 公制内六角 L 型扳手 · 彩色 · 带固持功能

- 固持功能确保螺丝牢固黏着在工具上

950 SPKL HF 公制内六角 L 型扳手 · 彩色 · 带固持功能

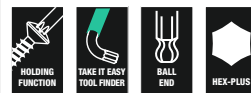

	EAN	⊙	L	L	L	L		
Code	4013288		mm	mm	mm			
05022200001	188342		3,0	123	21	4 7/8"	27/32"	10
05022201001	188359		4,0	137	24	5 3/8"	1"	10
05022202001	188366		5,0	154	27	6 1/16"	1 1/16"	10
05022203001	188373		6,0	172	31	6 3/4"	1 1/4"	10
05022204001	188380		8,0	195	37	7 11/16"	1 7/16"	10
05022205001	188397		10,0	224	42	9"	1 11/16"	10

950 SPKL 内六角 L 型扳手 · 公制 · 彩色



Code	EAN		⊙	L	L	L	L	
			mm	mm	mm			
05022600001	167842		1,5	90	14	3 1/2"	9/16"	10
05022602001	167934		2,0	101	16	4"	5/8"	10
05022604001	167859		2,5	112	19	4 7/8"	3/4"	10
05022606001	167866		3,0	123	21	4 7/8"	27/32"	10
05022608001	167873		4,0	137	24	5 3/8"	1"	10
05022610001	167880		5,0	154	27	6 1/16"	1 1/16"	10
05022612001	167897		6,0	172	31	6 3/4"	1 1/4"	10
05022614001	167903		8,0	195	37	7 11/16"	1 7/16"	10
05022616001	167910		10,0	224	42	9"	1 11/16"	10

950 SPKL 内六角 L 型扳手 · 英制 · 彩色



Code	EAN		⊙	L	L	L	L	
				mm	mm			
05022630001	182500		5/64"	101	16	4"	5/8"	10
05022631001	182517		3/32"	112	19	4 7/16"	3/4"	10
05022632001	182524		1/8"	123	21	4 7/8"	27/32"	10
05022633001	182531		5/32"	137	24	5 3/8"	1"	10
05022634001	182548		3/16"	154	27	6 1/16"	1 1/16"	10
05022635001	182555		7/32"	172	31	6 3/4"	1 1/4"	10
05022636001	182562		1/4"	185	34	7 1/4"	1 5/16"	10
05022637001	182579		5/16"	195	37	7 11/16"	1 7/16"	10
05022638001	182586		3/8"	224	42	9"	1 11/16"	10

950 SPKS 内六角 L 型扳手 · 公制 · 彩色

- 短款

950 SPKS 内六角 L 型扳手 · 公制 · 彩色

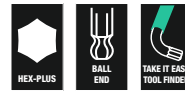

Code	EAN		⊙	L	L	L	L	
			mm	mm	mm			
05022678001	211910		1,5	50	14	2"	9/16"	10
05022670001	211934		2,0	56	16	2 7/32"	5/8"	10
05022671001	211927		2,5	63	19	2 1/2"	3/4"	10
05022672001	211941		3,0	71	21	2 3/4"	27/32"	10
05022673001	211958		4,0	80	24	3 1/8"	1"	10
05022674001	211965		5,0	90	27	3 1/2"	1 1/16"	10
05022675001	211972		6,0	100	31	4"	1 1/4"	10
05022676001	211989		8,0	112	37	4 7/16"	1 7/16"	10
05022677001	211996		10,0	125	42	5"	1 11/16"	10

950 SPKS 内六角 L 型扳手 · 英制 · 彩色

- 短款
- 英制

950 SPKS 内六角 L 型扳手 · 英制 · 彩色



Code	EAN		⊙	L	L	L	L	
				mm	mm			
05022651001	230201		5/64"	50	14	2"	9/16"	10
05022652001	230195		3/32"	56	16	2 7/32"	5/8"	10
05022653001	230218		1/8"	63	19	2 1/2"	3/4"	10
05022654001	230232		5/32"	71	21	2 3/4"	27/32"	10
05022655001	230249		3/16"	80	24	3 1/8"	1"	10
05022656001	230256		7/32"	90	27	3 1/2"	1 1/16"	10
05022657001	230263		1/4"	100	31	4"	1 1/4"	10
05022658001	230270		5/16"	112	37	4 7/16"	1 7/16"	10
05022659001	230287		3/8"	125	42	5"	1 11/16"	10

950 PKL 内六角 L 型扳手 · 公制 · 镀铬

- 镀铬, 具有高抗腐蚀性
- 长臂带六角形球头

950 PKL 内六角 L 型扳手 · 公制 · 镀铬



	EAN	⊙	L ₁	L ₂	L ₃	L ₄		
Code	4013288	mm	mm	mm				
05022050001 ¹⁾	018779	1,5	90	14	3 1/2"	9/16"		10
05022052001	018786	2,0	100	16	4"	5/8"		10
05022054001	018793	2,5	112	18	4 7/16"	23/32"		10
05022056001	018809	3,0	126	20	5"	25/32"		10
05022058001	018816	4,0	140	25	5 1/2"	1"		10
05022060001	018823	5,0	160	28	6 5/16"	1 3/32"		10
05022062001	018830	6,0	180	32	7 1/16"	1 1/4"		10
05022063001	037718	7,0	190	34	7 1/2"	1 5/16"		10
05022064001	018847	8,0	200	36	8"	1 7/16"		10
05022066001	018854	10,0	219	40	8 11/16"	1 9/16"		10
05022067001	038708	12,0	248	45	10"	1 3/4"		5

¹⁾ 正六边形

950 PKL BM 内六角 L 型扳手 · 公制 · 激光表面处理

- 激光发黑表面处理, 具有抗腐蚀性和较长的使用寿命
- 长臂带六角形球头

950 PKL BM 内六角 L 型扳手 · 公制 · 激光表面处理

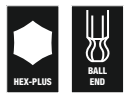

	EAN	⊙	L ₁	L ₂	L ₃	L ₄		
Code	4013288	mm	mm	mm				
05027101001 ¹⁾	094988	1,5	90	14	3 1/2"	9/16"		10
05027102001	094995	2,0	100	16	4"	5/8"		10
05027103001	095008	2,5	112	18	4 7/16"	23/32"		10
05027104001	095015	3,0	126	19	5"	3/4"		10
05027105001	095022	4,0	140	25	5 1/2"	1"		10
05027106001	095039	5,0	160	28	6 5/16"	1 3/32"		10
05027107001	095046	6,0	180	32	7 1/16"	1 1/4"		10
05027110001	095053	7,0	190	34	7 1/2"	1 5/16"		10
05027108001	095060	8,0	200	36	8"	1 7/16"		10
05027109001	095077	10,0	219	40	8 11/16"	1 9/16"		10
05027111001	095084	12,0	248	45	10"	1 3/4"		5

¹⁾ 正六边形

950 PKL 内六角 L 型扳手 · 英制 · 激光表面处理



	EAN	⊙	L ₁	L ₂	L ₃	L ₄		
Code	4013288	mm	mm	mm				
05022079001 ¹⁾	041203	0,05"	83	14	3 1/4"	9/16"		10
05022081001 ¹⁾	041210	1/16"	91	15	3 1/2"	19/32"		10
05022068001	018861	5/64"	100	16	4"	5/8"		10
05022070001	018878	3/32"	112	18	4 7/16"	23/32"		10
05022071001	041227	7/64"	119	19	4 3/4"	3/4"		10
05022072001	018885	1/8"	126	20	5"	25/32"		10
05022073001	041234	9/64"	132	23	5 3/16"	29/32"		10
05022074001	018892	5/32"	140	25	5 1/2"	1"		10
05022076001	018908	3/16"	160	25	6 5/16"	1"		10
05022078001	018915	7/32"	180	27	7 1/16"	1 1/16"		10
05022080001	018922	1/4"	190	34	7 1/2"	1 5/16"		10
05022082001	018939	5/16"	200	36	8"	1 7/16"		10
05022095001	038739	3/8"	212	38	8 3/8"	1 1/2"		5
05022096001	038746	1/2"	224	40	9"	1 9/16"		5

¹⁾ 正六边形

950 PKLS 内六角 L 型扳手 · 公制 · 镀铬

- 超短臂, 用于狭小区域内的螺丝

950 PKLS 内六角 L 型扳手 · 公制 · 镀铬



	EAN	⊙	L ₁	L ₂	L ₃	L ₄		
Code	4013288	mm	mm	mm				
05022040001 ¹⁾	139429	1,5	90	4,5	3 1/2"	11/64"		10
05022041001	139283	2,0	100	5,5	4"	7/32"		10
05022042001	139290	2,5	112	6,5	4 7/16"	1/4"		10
05022043001	139306	3,0	126	7,5	5"	19/64"		10
05022044001	139313	4,0	140	10,0	5 1/2"	25/64"		10
05022045001	139320	5,0	160	12	6 5/16"	15/32"		10
05022046001	139337	6,0	180	15	7 1/16"	19/32"		10
05022047001	139344	8,0	200	19	8"	3/4"		10
05022048001	139351	10,0	219	22	8 5/8"	7/8"		10

¹⁾ 正六边形

950 PKS 内六角 L 型扳手 · 公制 · 镀铬

- 短型设计, 用于空间特别狭小的作业场景

950 PKS 内六角 L 型扳手 · 公制 · 镀铬



Code	EAN	⊘	L ₁	L ₂	L ₃	L ₄		
05133150001 ¹⁾	098047	1,5	50	14	2"	9/16"		10
05133151001	098054	2,0	56	16	2 7/32"	5/8"		10
05133152001	098061	2,5	63	18	2 1/2"	23/32"		10
05133153001	098078	3,0	71	20	2 3/4"	25/32"		10
05133154001	098085	4,0	80	22	3"	29/32"		10
05133155001	098092	5,0	90	25	3 1/2"	1"		10
05133156001	098108	6,0	100	28	4"	1 3/32"		10
05133157001	098115	8,0	112	32	4 7/16"	1 1/4"		10
05133158001	098122	10,0	125	36	5"	1 5/16"		10

¹⁾ 正六边形

950 L HF 公制内六角 L 型扳手 · 镀铬镀铬 表面处理 · 带固持功能

- 长臂带球头, 可在狭小空间内作业

950 L HF 公制内六角 L 型扳手 · 镀铬镀铬 表面处理 · 带固持功能



Code	EAN	⊘	L ₁	L ₂	L ₃	L ₄		
05022120001	207258	3,0	126	20	5"	25/32"		10
05022121001	207265	4,0	140	25	5 1/2"	1"		10
05022122001	207319	5,0	160	28	6 3/16"	1 3/32"		10
05022123001	207326	6,0	180	32	7 1/16"	1 1/4"		10
05022124001	207340	8,0	200	36	8"	1 7/16"		10
05022125001	207333	10,0	219	40	8 11/16"	1 9/16"		5

950 内六角 L 型扳手 · 公制 · 镀铬



Code	EAN	⊘	L ₁	L ₂	L ₃	L ₄		
05021600001 ¹⁾	038722	1,5	90	14	3 1/2"	9/16"		10
05021605001	018656	2,0	100	16	4"	5/8"		10
05021610001	018663	2,5	112	18	4 7/16"	23/32"		10
05021615001	018670	3,0	126	20	5"	25/32"		10
05021620001	018687	4,0	140	25	5 1/2"	1"		10
05021625001	018694	5,0	160	28	6 5/16"	1 3/32"		10
05021630001	018700	6,0	180	32	7 1/16"	1 1/4"		10
05021632001	037701	7,0	190	30	7 1/2"	1 1/4"		10
05021635001	018717	8,0	200	36	8"	1 7/16"		10
05021640001	018724	10,0	219	40	8 11/16"	1 9/16"		5
05021645001	018731	12,0	250	45	10"	1 3/4"		5

¹⁾ 正六边形

950 内六角 L 型扳手 · 公制 · 镀铬



Code	EAN	⊘	L ₁	L ₂	L ₃	L ₄		
05021005001 ¹⁾	018267	1,5	45	14	1 3/4"	9/16"		10
05021010001	018274	2,0	50	16	2"	5/8"		10
05021015001	018281	2,5	56	18	2 7/32"	23/32"		10
05021020001	018298	3,0	63	20	2 1/2"	25/32"		10
05021025001	018304	3,5	66	23	2 5/8"	29/32"		10
05021030001	018311	4,0	70	25	2 3/4"	1"		10
05021035001	018328	4,5	75	26	3"	1 1/32"		10
05021040001	018335	5,0	80	28	3 1/8"	1 3/32"		10
05021045001	018342	6,0	90	32	3 1/2"	1 1/4"		10
05021050001	018359	7,0	95	34	3 3/4"	1 5/16"		10
05021055001	018366	8,0	100	36	4"	1 7/16"		10
05021060001	018373	9,0	106	38	4 3/16"	1 1/2"		10
05021065001	018380	10,0	112	40	4 7/16"	1 9/16"		10
05021070001	018397	11,0	120	43	4 3/4"	1 11/16"		10
05021075001	018403	12,0	125	45	5"	1 3/4"		10
05021080001	018410	13,0	132	50	5 3/16"	2"		10
05021085001 ¹⁾	018427	14,0	140	56	5 1/2"	2 7/32"		10
05021090001 ¹⁾	018434	17,0	160	63	6 5/16"	2 1/2"		5
05021095001 ¹⁾	018441	19,0	180	70	7 1/16"	2 3/4"		5

¹⁾ 正六边形

950 BM 内六角 L 型扳手 · 公制 · 激光表面处理



Code	EAN	⊙	L ₁	L ₂	L ₃	L ₄		
05027201001 ¹⁾	095381	1,5	45	14	1 3/4"	9/16"		10
05027202001	095398	2,0	50	16	2"	5/8"		10
05027203001	095541	2,5	56	18	2 7/32"	23/32"		10
05027204001	095404	3,0	63	20	2 1/2"	25/32"		10
05027205001	095411	3,5	66	23	2 5/8"	29/32"		10
05027206001	095428	4,0	70	25	2 3/4"	1"		10
05027207001	095435	4,5	75	26	3"	1 1/32"		10
05027208001	095442	5,0	80	28	3 1/8"	1 3/32"		10
05027209001	095459	6,0	90	32	3 1/2"	1 1/4"		10
05027210001	095466	7,0	95	34	3 3/4"	1 5/16"		10
05027211001	095473	8,0	100	36	4"	1 7/16"		10
05027213001	095480	9,0	106	38	4 11/64"	1 1/2"		10
05027212001	095497	10,0	112	40	4 7/16"	1 9/16"		10
05027214001	095503	11,0	120	43	4 23/32"	1 11/16"		10
05027215001	095510	12,0	125	45	5"	1 49/64"		10

¹⁾ 正六边形

Kraftform 不锈钢系列 – 避免生锈

维拉的不锈钢工具通过真空冰处以达到所需硬度和强度，可满足工业级别的应用。

不锈钢材质避免外因锈蚀形成

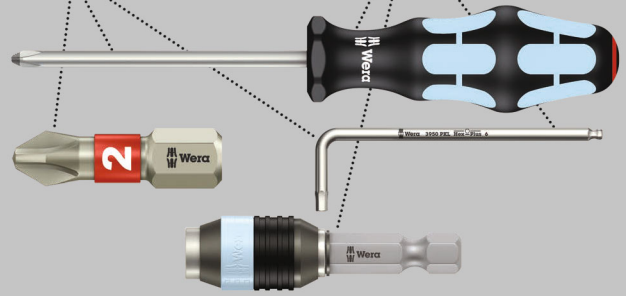

不锈钢L型扳手经过特殊硬化，达到与普通碳素钢工具相同的硬度，并且可以防止锈蚀产生。

维拉开发的HF工具对原有的TORX®梅花形状进行了优化，来自于驱动头和螺丝外形之间的表面压力形成了楔入力，从而使TORX®梅花螺丝能牢固黏着在工具上。

带热塑塑料护套的L型扳手用握持舒适的圆形材料制成，在低温环境下也能确保工作安全舒适。

颜色识别标识和印记方便找到需要的L型扳手。

- TORX®梅花螺丝固持功能
- 具有抗腐蚀性
- 紧凑且方便置放取出的热塑套
- 带颜色识别标识，易于握持的塑料护套可抵御低温

梅花齿廓固持工具系列

卡紧梅花型螺丝的楔入力

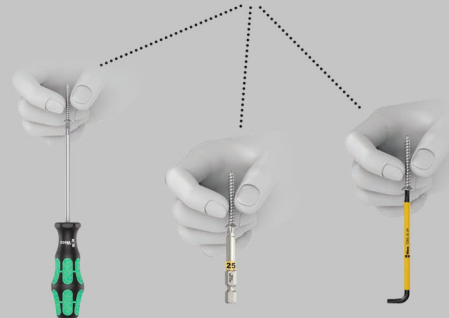

3967/9 TX SXL Multicolour HF Stainless 1 彩色 L 形扳手套装 · 带固持功能, 不锈钢



Code		EAN		
05022689001		4013288 207128		
		3967 SXL HF TORX® Multicolour 1x TX 8x90; 1x TX 9x101; 1x TX 10x112; 1x TX 15x123; 1x TX 20x137; 1x TX 25x154; 1x TX 27x172; 1x TX 30x195; 1x TX 40x224		1

967/9 TX XL Multicolour HF 1 梅花 L 型扳手组套 · 带固定功能 · 刀杆经镀锌磷化处理 · 长型

- 长臂杆带固持功能, 让螺丝能牢固附着在工具上
- 长款
- “易寻”色标系统: 用特定的颜色代表不同端头种类和尺寸

967/9 TX XL Multicolour HF 1 梅花 L 型扳手组套 · 带固定功能 · 刀杆经镀锌磷化处理 · 长型



Code		EAN		
05024470001		4013288 193537		
		967 SXL TORX® HF Multicolour 1x TX 8x90; 1x TX 9x101; 1x TX 10x112; 1x TX 15x123; 1x TX 20x137; 1x TX 25x154; 1x TX 27x172; 1x TX 30x195; 1x TX 40x224		1

967/9 TX Multicolour HF 1 彩色 L 形扳手套装 · 带固持功能

- 长臂杆带固持功能, 让螺丝能牢固附着在工具上
- “易寻”色标系统: 用特定的颜色代表不同端头种类和尺寸

967/9 TX Multicolour HF 1 彩色 L 形扳手套装 · 带固持功能

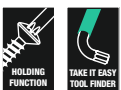

Code		EAN		
05024179001		4013288 185228		
		967 SL TORX® HF 1x TX 8x76; 1x TX 9x79; 1x TX 10x85; 1x TX 15x90; 1x TX 20x96; 1x TX 25x104; 1x TX 27x112; 1x TX 30x122; 1x TX 40x132		1

967/9 TX XL HF 1 梅花 L 型扳手组套 · 带固持功能 · 长型

- 长臂杆带固持功能, 让螺丝能牢固附着在工具上
- 长款

967/9 TX XL HF 1 梅花 L 型扳手组套 · 带固持功能 · 长型



Code		EAN		
05024450001		4013288 193513		
		967 XL HF TORX® 1x TX 8x90; 1x TX 9x101; 1x TX 10x112; 1x TX 15x123; 1x TX 20x137; 1x TX 25x154; 1x TX 27x172; 1x TX 30x195; 1x TX 40x224		1

967/9 TX HF 1 梅花 L 型扳手组套 · 带固持功能 · 激光表面处理

- 长臂杆带固持功能, 让螺丝能牢固附着在工具上

967/9 TX HF 1 梅花 L 型扳手组套 · 带固持功能 · 激光表面处理



Code		EAN		
05024244001		4013288 104953		
		967 L TORX® HF 1x TX 8x76; 1x TX 9x79; 1x TX 10x85; 1x TX 15x90; 1x TX 20x96; 1x TX 25x104; 1x TX 27x112; 1x TX 30x122; 1x TX 40x132		10

967/9 TX XL Multicolour 1 梅花 L 型扳手组套 · 彩色 · 长型



Code		EAN		
05024480001		4013288 193544		
		967 SXL TORX® Multicolour 1x TX 8x90; 1x TX 9x101; 1x TX 10x112		1
		967 SPKXL TORX® Multicolour 1x TX 15x123; 1x TX 20x137; 1x TX 25x154; 1x TX 27x172; 1x TX 30x195; 1x TX 40x224		

967/9 TX B0 Multicolour 1 梅花 L 型扳手组套 · 彩色 · 激光表面处理

- L型扳手, 用于TORX® B0防盗梅花螺丝, 可松开安全连接

967/9 TX B0 Multicolour 1 梅花 L 型扳手组套 · 彩色 · 激光表面处理



Code	EAN		
	4013288		
05024335001	180858		10
		967 SPKL TORX® B0 Multicolour 1x TX 8x76 ¹⁾ ; 1x TX 9x79 ¹⁾ ; 1x TX 10x85 ²⁾ ; 1x TX 15x90; 1x TX 20x96; 1x TX 25x104; 1x TX 27x112; 1x TX 30x122; 1x TX 40x132	

- ¹⁾ 不带安全销和球头
²⁾ 长臂不带球头

967/9 TX B0 Multicolour 1 SB 梅花 L 型扳手组套吊卡装 · 彩色 · BlackLaser 表面处理



Code	EAN		
	4013288		
05073599001	170125	967 SPKL TORX® B0 Multicolour 1x TX 8x76 ¹⁾ ; 1x TX 9x79 ¹⁾ ; 1x TX 10x85 ²⁾ ; 1x TX 15x90; 1x TX 20x96; 1x TX 25x104; 1x TX 27x112; 1x TX 30x122; 1x TX 40x132;	1

- ¹⁾ 不带安全销和球头
²⁾ 长臂不带球头

967/9 TX XL 1 梅花 L 型扳手组套 · 长型

- 长款

967/9 TX XL 1 梅花 L 型扳手组套 · 长型



Code	EAN		
	4013288		
05024460001	193520		1
		967 XL TORX® 1x TX 8x90; 1x TX 9x101; 1x TX 10x112	
		967 PKXL TORX® 1x TX 15x123; 1x TX 20x137; 1x TX 25x154; 1x TX 27x172; 1x TX 30x195; 1x TX 40x224	

967/9 TX 1 梅花 L 型扳手组套 · 激光表面处理



Code	EAN		
	4013288		
05024242001	104946		10
		967 PKL TORX® 1x TX 8x76 ¹⁾ ; 1x TX 9x79 ¹⁾ ; 1x TX 10x85 ¹⁾ ; 1x TX 15x90; 1x TX 20x96; 1x TX 25x104; 1x TX 27x112; 1x TX 30x122; 1x TX 40x132	

- ¹⁾ 长臂不带球头

967/9 TX 1 SB 梅花 L 型扳手组套吊卡装 · 激光表面处理

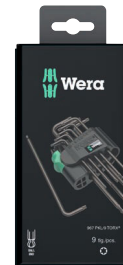

Code	EAN		
	4013288		
05073598001	106438	967 PKL TORX® 1x TX 8x76 ¹⁾ ; 1x TX 9x79 ¹⁾ ; 1x TX 10x85 ¹⁾ ; 1x TX 15x90; 1x TX 20x96; 1x TX 25x104; 1x TX 27x112; 1x TX 30x122; 1x TX 40x132	1

- ¹⁾ 长臂不带球头

Kraftform 不锈钢系列 – 避免生锈

维拉的不锈钢工具通过真空冰处理以达到所需硬度和强度，可满足工业级别的应用。

不锈钢材质避免外因锈蚀形成

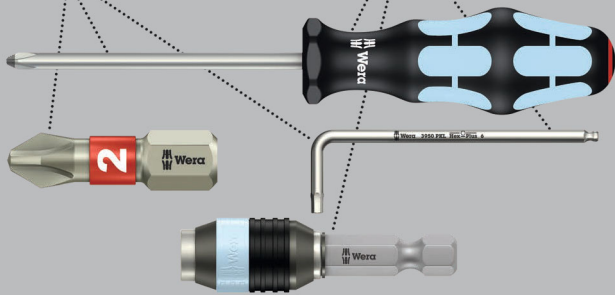

3967 SXL HF TORX® 梅花 L 型扳手，彩色，长型，带固持功能，公制



Code	EAN		⬠	┌	└	┌	└	📦
Code	4013288			mm	mm			
05022680001	207135		TX 8	90	16	3 1/2"	5/8"	10
05022681001	207142		TX 9	101	16	4"	5/8"	10
05022682001	207159		TX 10	112	19	4 7/16"	3/4"	10
05022683001	207166		TX 15	123	21	4 7/8"	27/32"	10
05022684001	207173		TX 20	137	24	5 3/8"	1"	10
05022685001	207180		TX 25	154	27	6 1/16"	1 1/16"	10
05022686001	207197		TX 27	172	31	6 3/4"	1 1/4"	10
05022687001	207203		TX 30	195	37	7 11/16"	1 7/16"	10
05022688001	207210		TX 40	224	42	9"	1 11/16"	10

967 SXL HF TORX® 梅花 L 型扳手，彩色，长型，带固持功能

• 长臂杆带固持功能，让螺丝能牢固附着在工具上

967 SXL HF TORX® 梅花 L 型扳手，彩色，长型，带固持功能



Code	EAN		⬠	┌	└	┌	└	📦
Code	4013288			mm	mm			
05024471001	194145		TX 8	90	16	3 1/2"	5/8"	10
05024472001	194152		TX 9	101	16	4"	5/8"	10
05024473001	194169		TX 10	112	19	4 7/16"	3/4"	10
05024474001	194176		TX 15	123	21	4 7/8"	27/32"	10
05024475001	194183		TX 20	137	24	5 3/8"	1"	10
05024476001	194190		TX 25	154	27	6 1/16"	1 1/16"	10
05024477001	194206		TX 27	172	31	6 3/4"	1 1/4"	10
05024478001	194213		TX 30	195	37	7 11/16"	1 7/16"	10
05024479001	194220		TX 40	224	42	9"	1 11/16"	10

967 SPKXL TORX® 梅花 L 型扳手，彩色，长型

• 加长型设计

967 SPKXL TORX® 梅花 L 型扳手，彩色，长型



Code	EAN		⬠	┌	└	┌	└	📦
Code	4013288			mm	mm			
05024484001	194305		TX 15	123	21	4 7/8"	27/32"	10
05024485001	194312		TX 20	137	24	5 3/8"	1"	10
05024486001	194329		TX 25	154	27	6 1/16"	1 1/16"	10
05024487001	194336		TX 27	172	31	6 3/4"	1 1/4"	10
05024488001	194343		TX 30	195	37	7 11/16"	1 7/16"	10
05024489001	194350		TX 40	224	42	9"	1 11/16"	10

967 SL TORX® HF 梅花 L 型扳手，彩色，长型，带固持功能

• 长臂杆带固持功能，让螺丝能牢固附着在工具上

967 SL TORX® HF 梅花 L 型扳手，彩色，长型，带固持功能



Code	EAN		⬠	┌	└	┌	└	📦
Code	4013288			mm	mm			
05024170001	185235		TX 8	76	16	3"	5/8"	5
05024171001	185242		TX 9	79	16	3 1/8"	5/8"	5
05024172001	185259		TX 10	85	17	3 1/4"	21/32"	5
05024173001	185266		TX 15	90	18	3 1/2"	23/32"	5
05024174001	185273		TX 20	96	19	3 3/4"	3/4"	5
05024175001	185280		TX 25	104	21	4 1/8"	27/32"	5
05024176001	185297		TX 27	112	22	4 7/16"	29/32"	5
05024177001	185303		TX 30	122	24	4 13/16"	1"	5
05024178001	185310		TX 40	132	27	5 3/16"	1 1/16"	5

967 SPKL TORX® B0 梅花 L 型扳手 · 彩色 · 激光表面处理

- L型扳手, 用于TORX®防盗梅花螺丝

967 SPKL TORX® B0 梅花 L 型扳手 · 彩色 · 激光表面处理



Code	EAN		🌀	L	L	L	L	📦
				mm	mm			
05024350001 ¹⁾	172679		TX 8	76	16	3"	5/8"	10
05024351001 ¹⁾	172686		TX 9	79	16	3 1/8"	5/8"	10
05024352001 ²⁾	172693		TX 10	85	17	3 3/8"	21/32"	10
05024353001	172709		TX 15	90	18	3 1/2"	23/32"	10
05024354001	172716		TX 20	96	19	3 3/4"	3/4"	10
05024355001	172723		TX 25	104	21	4 1/8"	27/32"	10
05024356001	172730		TX 27	112	22	4 7/16"	29/32"	10
05024357001	172747		TX 30	122	24	4 13/16"	1"	10
05024358001	172754		TX 40	132	27	5 3/16"	1 1/16"	10

¹⁾ 不带安全销和球头
²⁾ 长臂不带球头

967 SXL TORX® 梅花 L 型扳手 · 彩色 · 长型

- 长款

967 SXL TORX® 梅花 L 型扳手 · 彩色 · 长型



Code	EAN		🌀	L	L	L	L	📦
				mm	mm			
05024481001	194275		TX 8	90	16	3 1/2"	5/8"	10
05024482001	194282		TX 9	101	16	4"	5/8"	10
05024483001	194299		TX 10	112	19	4 7/16"	3/4"	10

967 XL HF TORX® 梅花 L 型扳手 · 带固持功能 · 长型

- 长臂杆带固持功能, 让螺丝能牢固附着在工具上

967 XL HF TORX® 梅花 L 型扳手 · 带固持功能 · 长型



Code	EAN	🌀	L	L	L	L	📦
			mm	mm			
05024451001	193674	TX 8	90	16	3 1/2"	5/8"	10
05024452001	193681	TX 9	101	16	4"	5/8"	10
05024453001	193698	TX 10	112	19	4 7/16"	3/4"	10
05024454001	193704	TX 15	123	21	4 7/8"	21/32"	10
05024455001	193711	TX 20	137	24	5 3/8"	1"	10
05024456001	193728	TX 25	154	27	6 1/16"	1 1/16"	10
05024457001	193735	TX 27	172	31	6 3/4"	1 1/4"	10
05024458001	193742	TX 30	195	37	7 11/16"	1 7/16"	10
05024459001	193759	TX 40	224	42	9"	1 11/16"	10

967 PKXL TORX® 梅花 L 型扳手 · 长型

- 长臂带TORX®球头

967 PKXL TORX® 梅花 L 型扳手 · 长型



Code	EAN	🌀	L	L	L	L	📦
			mm	mm			
05024464001	194084	TX 15	123	21	4 7/8"	27/32"	10
05024465001	194091	TX 20	137	24	5 3/8"	1"	10
05024466001	194107	TX 25	154	27	6 1/16"	1 1/16"	10
05024467001	194114	TX 27	172	31	6 3/4"	1 1/4"	10
05024468001	194121	TX 30	195	37	7 11/16"	1 7/16"	10
05024469001	194138	TX 40	224	42	9"	1 21/32"	10

967 XL TORX® 梅花 L 型扳手 · 长型

- 加长型设计

967 XL TORX® 梅花 L 型扳手 · 长型



	EAN						
Code	4013288		mm	mm			
05024461001	194053	TX 8	90	16	3 1/2"	5/8"	10
05024462001	194060	TX 9	101	16	4"	5/8"	10
05024463001	194077	TX 10	112	19	4 7/16"	3/4"	10

967 PKL TORX® 梅花 L 型扳手 · 激光表面处理

- 长臂带TORX®球头

967 PKL TORX® 梅花 L 型扳手 · 激光表面处理



	EAN						
Code	4013288		mm	mm			
05024199001 ¹⁾	104939	TX 8	76	16	3"	5/8"	5
05024100001 ¹⁾	035035	TX 9	79	16	3 1/8"	5/8"	5
05024105001 ¹⁾	019431	TX 10	85	17	3 3/8"	21/32"	5
05024200001	019547	TX 15	90	18	3 1/2"	23/32"	5
05024202001	019554	TX 20	96	19	3 3/4"	3/4"	5
05024204001	019561	TX 25	104	21	4 1/8"	27/32"	5
05024206001	019578	TX 27	112	22	4 7/16"	29/32"	5
05024208001	019585	TX 30	122	24	4 13/16"	1"	5
05024210001	019592	TX 40	132	27	5 3/16"	1 1/16"	5

¹⁾ 长臂不带球头

967 L TORX® HF 梅花 L 型扳手 · 带固定功能 · 激光表面处理

- 长臂杆带固持功能, 让螺丝能牢固附着在工具上

967 L TORX® HF 梅花 L 型扳手 · 带固定功能 · 激光表面处理



	EAN						
Code	4013288		mm	mm			
05024160001	104847	TX 8	76	16	3"	5/8"	5
05024161001	104922	TX 9	79	16	3 1/8"	5/8"	5
05024162001	104854	TX 10	85	17	3 1/4"	21/32"	5
05024163001	104861	TX 15	90	18	3 1/2"	23/32"	5
05024164001	104878	TX 20	96	19	3 3/4"	3/4"	5
05024165001	104885	TX 25	104	21	4 1/8"	27/32"	5
05024166001	104892	TX 27	112	22	4 7/16"	29/32"	5
05024167001	104908	TX 30	122	24	4 13/16"	1"	5
05024168001	104915	TX 40	132	27	5 3/16"	1 1/16"	5

967 TORX® 梅花 L 型扳手 · 激光表面处理



	EAN						
Code	4013288		mm	mm			
05024001001	019257	TX 6	42	16	1 5/8"	5/8"	5
05024002001	019264	TX 7	48	16	1 7/8"	5/8"	5
05024003001	019271	TX 8	48	16	1 7/8"	5/8"	5
05024004001	019288	TX 9	48	16	1 7/8"	5/8"	5
05024005001	019295	TX 10	51	17	2"	21/32"	5
05024008001	019301	TX 15	54	18	2 1/8"	23/32"	5
05024010001	019318	TX 20	57	19	2 1/4"	3/4"	5
05024012001	019325	TX 25	60	20	2 3/8"	25/32"	5
05024013001	019332	TX 27	64	21	2 1/2"	27/32"	5
05024015001	019349	TX 30	70	24	2 3/4"	1"	5
05024020001	019356	TX 40	76	26	3"	1 1/32"	5



Kraftform Kompakt



Kraftform Kompakt Turbo 1

许多用户都希望不做任何妥协, 想有效松拧螺丝。如何让一把螺丝刀, 即能精确并且有力的紧固, 同时又能快速转动? 维拉创造了拥有开关按钮的齿轮变速机构来解决这一难题: 变速齿轮内置于螺丝手柄内, 一手握住前端, 一手握住末端, 可提升四倍作业速度 (公制)。

Kraftform Turbo使用纯机械工程的原理提高转动的速度。Turbo功能可以通过按钮开启或关闭。

当需要精确调试或高扭矩上紧或松开螺丝时, 可关闭这一功能。

耐用的变速齿轮设计几乎不需要定期的维护, 环保而且耐用, 再关闭Turbo功能时, 最大扭矩可达14扭米。

通过Rapidaptor 接头, Kraftform Turbo可插换搭配通用 1/4" 六角批头, 应用于各类螺丝花形。

带Rapidaptor接头的手柄可快速装卸批头, 只需将衬套轻轻向前一推便可退出批头批头, 即使单手也可轻松更换批头。

- 不需要电池, 只使用人力 (手) 驱动下作业下可瞬间提高转动速度四倍的插换式螺丝刀柄 (公制)
- 按下按钮启动和关闭 Turbo功能
- 灵活的金属齿轮机构有效传递扭力, 轻松完成精调
- 关闭Turbo功能时, 可以像正常螺丝刀般使用
- 零维护的金属耐用齿轮

Kraftform Kompakt Turbo 1



Code	EAN		
05057482001	4013288 214614		1
		● 826 T Kraftform Turbo 1x 1/4"x146	
		⊕ 851/4 Z 1x PH 1x89; 1x PH 2x89; 1x PH 3x89 ¹⁾	
		⊕ 855/4 Z 1x PZ 1x89; 1x PZ 2x89; 1x PZ 3x89 ¹⁾	
		⊕ 867/4 Z TORX® 1x TX 10x89; 1x TX 15x89; 1x TX 20x89; 1x TX 25x89; 1x TX 30x89	
		○ 840/4 Z 1x 3,0x89; 1x 4,0x89; 1x 5,0x89; 1x 6,0x89 ¹⁾	
		◐ 800/4 Z 1x 0,8x4,0x89; 1x 1,0x5,5x89; 1x 1,2x6,5x89	
		魔术贴 120 1x 50,0x120,0	

¹⁾六角形刀片

Kraftform Kompakt Turbo Imperial 1



Code	EAN		
05057483001	4013288 214621		1
		● 826 T Kraftform Turbo 1x 1/4"x146	
		⊕ 851/4 Z PH 1x PH 1x89; 1x PH 2x89; 1x PH 3x89 ¹⁾	
		⊕ 867/4 Z TORX® 1x TX 10x89; 1x TX 15x89; 1x TX 20x89; 1x TX 25x89; 1x TX 30x89	
		○ 840/4 Z Hex-Plus 1x 3/32"x89; 1x 1/8"x89; 1x 5/32"x89; 1x 3/16"x89	
		◐ 868/4 Square-Plus 1x # 1x89; 1x # 2x89; 1x # 3x89	
		◐ 800/4 Z 1x 0,8x4,0x89; 1x 1,0x5,5x89; 1x 1,2x6,5x89	
		魔术贴 120 1x 50,0x120,0	

¹⁾六角形刀片

带Rapidaptor快速接头的826 T Kraftform Turbo 螺丝刀柄

- 不需要电池, 只使用人力(手) 驱动下作业下可瞬间提高转动速度四倍的插换式螺丝刀柄(公制)
- 按下按钮启动和关闭 Turbo功能
- 灵活的金属齿轮机构有效传递扭力, 轻松完成精调
- 关闭Turbo功能时, 可以像正常螺丝刀般使用
- 零维护的金属耐用齿轮

带Rapidaptor快速接头的826 T Kraftform Turbo 螺丝刀柄



Code	EAN	⌀	l ¹						
05057480001	214591	1/4"	146						1

Kraftform Kompakt 10, 12

10件套。1个Kraftform 813 R带Rapidaptor快速接头的手柄。

抗扭批头通过缩小中间杆部的直径, 让批头抵抗冲击的能力有显著提高, 从而避免提早失效的情况。快速批头接杆, 用于1/4"六角驱动的批头

- Kraftform夹具带快速接头
- 抗扭设计批头, 避免早期磨损
- 坚固而具有韧性的通用批头
- 便捷而坚固的包装

Kraftform Kompakt 10



Code	EAN			
05056653001	4013288 041647			1
		●	813 R 1x 1/4"x90	
		+	851/1 TZ PH 1x PH 1x25; 1x PH 2x25	
		+	855/1 TZ PZ 1x PZ 1x25; 1x PZ 2x25	
		✳	867/1 TZ TORX® 1x TX 10x25; 1x TX 15x25; 1x TX 20x25	
		⊖	800/1 TZ 1x 0,5x4,0x25; 1x 1,0x5,5x25	

Kraftform Kompakt 12



Code	EAN			
05135942001	4013288 155887			1
		●	813 R 1x 1/4"x90	
		+	851/1 J 1x PH 00x25x2,0 ¹⁾ ; 1x PH 0x25x2,5 ²⁾ ; 1x PH 1x25x3,0	
		+	851/1 TZ PH 1x PH 2x25	
		✳	867/1 TZ TORX® 1x TX 5x25; 1x TX 6x25; 1x TX 7x25; 1x TX 8x25; 1x TX 9x25	

¹⁾ 尺寸00根据JICIS 00 (日本相机工业标准) 修改

²⁾ 尺寸0根据JICIS 0 (日本相机工业标准) 修改

Kraftform 随身包 20 – 能屈能伸，内里别有洞天

快速接头可快速装卸批头

可以更换的刺刀型刀杆同时也适用于气动工具

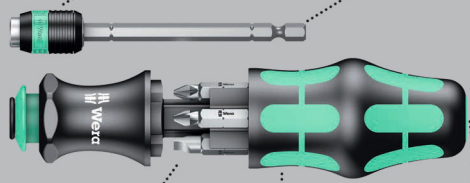

Kraftform握柄

可存放六个批头于握柄中的存放夹

批头存放夹的弹出模式

用户一般在固定场所内使用工具，并且通常只有到了工作现场才能准确判断应该使用手动工具还是电动工具。

Kraftform Kompakt套装内的工具可适用于这两种作业。

独特设计带有的快速接头的手柄能快速换装刀杆，足以应对多样化的应用。

用于DIN ISO 1173-C 6.3和E 6.3标准的1/4"内六角批头，以及维拉系列1和4的批头。内置式批头仓，用于储存批头。

- Kraftform夹具带可伸缩刀杆和快速接头
- Kraftform多重材料手柄，带防滚动保护，内置批头仓
- 可伸缩式刀杆
- “易寻”色标系统：用特定的颜色代表不同端头种类和尺寸
- 坚固的腰包装

Take it easy 彩色工具搜寻系统 – 快速辨识

批头“Take it easy”工具搜寻系统 – 让使用者能够简捷地辨识运用不同颜色选取需要的



Zyklop 套筒“Take it easy”工具搜寻系统 – 让使用者能够简捷地运用不同颜色辨识选取需要的



L型扳手“Take it easy”工具搜寻系统-让使用者能够简捷地运用不同颜色辨识选取需要的尺寸



Joker两用棘轮扳手“Take it easy”工具搜寻系统-让使用者能够简捷地运用不同颜色辨识选取需要的工具



Kraftform Kompakt 20 Tool Finder 1 带织布包



Code	EAN		
05051016001	4013288 185327		1
		889/4 R 1x 1/4"x100	
		851/1 BTZ 1x PH 1x25; 1x PH 2x25	
		855/1 BTZ 1x PZ 1x25; 1x PZ 2x25	
		867/1 TORX® BTZ 1x TX 25x25	
		800/1 BTZ 1x 0,8x5,5x25	
		魔术贴 70 1x 50,0x70,0	

Kraftform Kompakt 20 Tool Finder 2 带织布包

13件紧凑型高力矩外形设计组件，具有6x 25mm长型和6x 89mm长型批头。

通过Wera紧凑型工具，可同时使用两种类型的螺纹连接；“手动”或“机器操作”。手柄批头更换系统，采用紧凑型设计，具有不同的紧凑型刀片尖部，用户可移动使用位置，且应用灵活。适用于符合DIN ISO 1173-C 6.3和E 6.3 (ISO 1173) 要求的1/4"六角驱动的批头，以及Wera批头系列1和4。带接杆、固定销、Rapidaptor技术、带防滚动保护的Kraftform手柄，多组件设计，可在旋拧操作时获得尤为突出的人机工程学应用效果。弹夹式收纳盒用于存放25mm长型批头。

此组件替换了12件装的螺丝刀组件，同时最大程度减少的所需携带的工具数量。

- 6x25mm批头，“易寻”色标系统，可轻松找到所需批头，以及6x89mm批头

Kraftform Kompakt 20 Tool Finder 2 带织布包



Code	EAN			
05051017001	4013288 211224			1
		889/4 R	1x 1/4"x100	
		851/1 BTZ	1x PH 1x25; 1x PH 2x25	
		855/1 BTZ	1x PZ 1x25; 1x PZ 2x25	
		867/1 TORX® BTZ	1x TX 20x25; 1x TX 25x25	
		851/4 Z	1x PH 1x89; 1x PH 2x89	
		855/4 Z	1x PZ 1x89; 1x PZ 2x89	
		867/4 Z TORX®	1x TX 20x89; 1x TX 25x89	
		魔术贴 70	1x 50,0x70,0	

Kraftform Kompakt 20 · 带帆布包



Code	EAN			
05051021001	4013288 098917			1
		889/4 R	1x 1/4"x100	
		851/1 Z	1x PH 1x25; 1x PH 2x25	
		855/1 Z	1x PZ 1x25; 1x PZ 2x25	
		800/1 Z	1x 1,0x5,5x25; 1x 1,2x6,5x25	
		魔术贴 70	1x 50,0x70,0	

Kraftform Kompakt 25 · 带帆布织包



Code	EAN		
05051024001	4013288 098931		1
		889/4 R 1x 1/4"x100	
		851/1 Z 1x PH 1x25; 1x PH 2x25; 1x PH 3x25	
		800/1 Z 1x 0,6x4,5x25; 1x 1,0x5,5x25; 1x 1,2x6,5x25	
		魔术贴 70 1x 50,0x70,0	

Kraftform Kompakt 26 · 带帆布织包



Code	EAN		
05051025001	4013288 098948		1
		889/4 R 1x 1/4"x100	
		851/1 Z 1x PH 1x25; 1x PH 2x25	
		800/1 Z 1x 1,0x5,5x25; 1x 1,2x6,5x25	
		868/1 Z 1x # 1x25; 1x # 2x25	
		魔术贴 70 1x 50,0x70,0	

Kraftform Kompakt 27 XL 通用型 1

通用的批头组套。带 300 mm 长刀杆的批头夹持螺丝刀，非常纤薄，可锁定的批头支座，可触及难以触及的区域。因其设计特别纤薄，即使是安装空间非常狭小的螺丝也可以操作。

Kraftform 多重材料手柄，符合人体工程学，可快速拆装螺丝。手柄中整合的批头库用于存储批头。6 个 25 mm 长的硬批头（十字螺丝、米字螺丝和 TORX® 螺丝）。

该组套取代了 6 件螺丝刀组套，将所需设备降至最少。采用六角防滑保护，防止滚动松脱。

- 通用
- 300 mm 长的刚性刀杆
- 批头固定器采用超薄设计，适合在狭小空间内使用
- 采用锁止机构，具有安全的批头固定功能。带强磁性磁铁
- 紧凑型不锈钢固定器，适合具有 1/4 英寸外六角驱动头的批头，依照 DIN 3126, ISO 1173 表 C 6.3
- 6 个硬批头，通用

Kraftform Kompakt 27 XL 通用型 1



Code	EAN		
05051028001	4013288 229588		1
		851/1 BTZ 1x PH 1x25; 1x PH 2x25	
		855/1 BTZ 1x PZ 2x25	
		867/1 TORX® BTZ 1x TX 15x25; 1x TX 20x25; 1x TX 25x25	
		394 S 1x 1/4"x300	

Kraftform Kompakt 27 XL 通用型 Imperial 组套 1

- 批头库中有 6 个批头：十字头、一字头和方头 (Robertson); 坚固耐用

Kraftform Kompakt 27 XL 通用型 Imperial 组套 1



Code	EAN			
05051032001	229724			1
		+	851/1 Z 1x PH 1x25; 1x PH 2x25	
		-	800/1 Z 1x 1,0x5,5x25; 1x 1,2x6,5x25	
		□	868/1 Z 1x # 1x25; 1x # 2x25	
		●	394 S 1x 1/4"x300	

Kraftform Kompakt 27 XL SHK 1

- 特别适用于管道、供暖和空调操作应用

Kraftform Kompakt 27 XL SHK 1



Code	EAN			
05136075001	228994			1
		+	851/1 Z 1x PH 2x25	
		★	867/1 TORX® 1x TX 15x25; 1x TX 20x25; 1x TX 25x25	
		○	840/1 Z 1x 5,0x25; 1x 6,0x25	
		●	394 S 1x 1/4"x300	

Kraftform Kompakt 27 组套 1

Wera 紧凑工具和 Kraftform 多重材料手柄，符合人体工程学，可快速拆装螺丝。手柄中整合有批头库，6 个批头带有扭矩区，由此可防止批头刀头在高负载下扭转。这显著增加了产品寿命。

配 Take it easy 易寻色标系统：用特定颜色代表不同端头种类和尺寸。带有能够安全固定批头的强力永磁铁的批头固持器。

- 批头手动固持器，配批头库
- 带强力永磁铁的批头固持器，可稳定固持批头
- 批头库中有 6 个 BiTorsion 批头：十字头、PZ 米字、TORX® 以及一字螺丝；坚固
- “易寻”色标系统：用特定的颜色代表不同端头种类和尺寸

Kraftform Kompakt 27 组套 1



Code	EAN			
05051510001	226556			1
		●	828/1 1x 1/4"	
		+	851/1 BTZ 1x PH 1x25; 1x PH 2x25	
		★	855/1 BTZ 1x PZ 2x25	
		★	867/1 TORX® BTZ 1x TX 20x25; 1x TX 25x25	
		-	800/1 BTZ 1x 0,8x5,5x25	

Kraftform Kompakt 27 组套 2

- 批头库中有 6 个批头: 十字头和一字头螺丝; 坚固耐用

Kraftform Kompakt 27 组套 2



Code	EAN		
05051511001	4013288 226587		1
		● 828/1 1x 1/4"	
		⊕ 851/1 Z 1x PH 1x25; 1x PH 2x25; 1x PH 3x25	
		⊖ 800/1 Z 1x 0,6x4,5x25; 1x 1,0x5,5x25; 1x 1,2x6,5x25	

Kraftform Kompakt 27 Imperial 组套 1

- 批头库中有 6 个批头: 十字头、一字头和方头 (Robertson); 坚固耐用

Kraftform Kompakt 27 Imperial 组套 1



Code	EAN		
05051512001	4013288 226594		1
		● 828/1 1x 1/4"	
		⊕ 851/1 Z 1x PH 1x25; 1x PH 2x25	
		⊖ 800/1 Z 1x 1,0x5,5x25; 1x 1,2x6,5x25	
		□ 868/1 Z 1x # 1x25; 1x # 2x25	

Kraftform Kompakt 28 SB

Kraftform Kompakt 28系列真的是无与伦比。A2位置的伸缩式刀杆可以缩到手柄里以便在狭窄的空间里进行操作,也可以延伸以便更好地接触到工件,甚至可以拆下来作为100mm的电动工具批头接杆。

6个批头整合在自动开关的批头仓里。

- 可伸缩刀杆, 带不锈钢护套、卡环和强磁性磁铁
- 坚固而具有韧性的通用批头

Kraftform Kompakt 28 SB

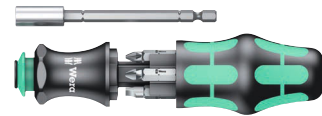

Code	EAN		
05073240001	4013288 138927		1
		⊕ 851/1 Z PH 1x PH 1x25; 1x PH 2x25	
		⊕ 855/1 Z PZ 1x PZ 1x25; 1x PZ 2x25	
		⊖ 800/1 Z 1x 1,0x5,5x25; 1x 1,2x6,5x25	

Kraftform Kompakt 28 Imperial 1

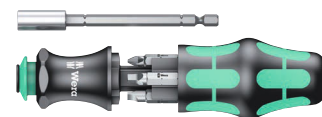

Code	EAN		
05073241001	4013288 214676		1
		⊕ 851/1 Z PH 1x PH 1x25; 1x PH 2x25	
		□ 868/1 Z 1x # 1x25; 1x # 2x25	
		⊖ 800/1 Z 1x 1,0x5,5x25; 1x 1,2x6,5x25	

Kraftform Kompakt 28 · 带织布包



Code	EAN		
	4013288		
05134491001	175373		1
		+	851/1 Z 1x PH 1x25; 1x PH 2x25
		+	855/1 Z 1x PZ 1x25; 1x PZ 2x25
		-	800/1 Z 1x 1,0x5,5x25; 1x 1,2x6,5x25
			魔术贴 70 1x 50,0x70,0

Kraftform Kompakt 40 和 41

- 89mm长批头，腰包装
- Kraftform夹具带快速接头
- 快速接头可快速更换批头
- 坚固而具有韧性的通用批头
- 符合人体工程学的Kraftform手柄，降低作业疲劳程度

Kraftform Kompakt 40



Code	EAN		
	4013288		
05059298001	096319		1
		●	816 R 1x 1/4"x119
		+	851/4 Z 1x PH 1x89; 1x PH 2x89
		+	855/4 Z 1x PZ 1x89; 1x PZ 2x89
		-	800/4 Z 1x 1,0x5,5x89; 1x 1,2x6,5x89
			魔术贴 70 1x 50,0x70,0

Kraftform Kompakt 41



Code	EAN		
	4013288		
05059299001	096326		1
		●	816 R 1x 1/4"x119
		+	851/4 Z 1x PH 1x89; 1x PH 2x89; 1x PH 3x89 ¹⁾
		+	855/4 Z 1x PZ 1x89; 1x PZ 2x89; 1x PZ 3x89 ¹⁾
		♻️	867/4 Z TORX® B0 1x TX 15x89; 1x TX 20x89; 1x TX 25x89; 1x TX 30x89
			魔术贴 70 1x 50,0x70,0

¹⁾六角形刀片



Kraftform Kompakt 60 · 扭矩 1.2-3.0 Nm

Kraftform可调式扭矩螺丝刀, 带快速接头。可以直接手动设定所需的扭矩数值, 易于读取的刻度值。

测量精度为±6%, 符合EN ISO 6789标准。达到设定扭矩数值时可听到清晰的超负荷空转信号。

- Kraftform可调式扭矩螺丝刀, 带快速接头
- Kraftform多重材料手柄, 符合人体工程学, 可快速拆装螺丝
- Rapidaptor技术可快速更换批头
- 用于手动和电动工具
- 实用帆布包装, 方便整齐存放

Kraftform Kompakt 60 · 扭矩 1.2-3.0 Nm



Code	EAN		
05059293001	169624		1
		7400 1x 7441, 1/4", 1,2-3,0 Nm	
		851/4 Z PH 1x PH 1x89; 1x PH 2x89; 1x PH 3x89 ¹⁾	
		855/4 Z PZ 1x PZ 1x89; 1x PZ 2x89; 1x PZ 3x89 ¹⁾	
		867/4 Z TORX® BO 1x TX 10x89; 1x TX 15x89; 1x TX 20x89; 1x TX 25x89; 1x TX 30x89	
		800/4 Z 1x 1,0x5,5x89	
		840/4 Z Hex-Plus 1x 3,0x89; 1x 4,0x89; 1x 5,0x89; 1x 6,0x89 ¹⁾	

¹⁾六角形刀片

Kraftform 不锈钢系列 – 避免生锈

维拉的不锈钢工具通过真空冰处以达到所需硬度和强度, 可满足工业级别的应用。

不锈钢材质避免外因锈蚀形成

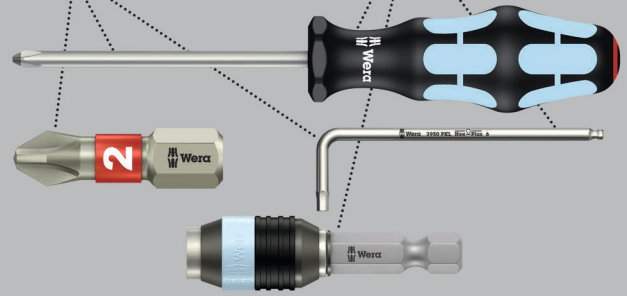

89mm批头, 织布包装, 由不锈钢材料制成。17件套。1个 Kraftform 3816 R 不锈钢可拆卸式伸缩杆, 带Rapidaptor快速接头。

Kraftform Kompakt 60 · 不锈钢



Code	EAN		
05071116001	115713		1
		3816 R 1x 1/4"x119	
		3851/4 1x PH 1x89; 1x PH 2x89; 1x PH 3x89 ¹⁾	
		3855/4 1x PZ 1x89; 1x PZ 2x89; 1x PZ 3x89 ¹⁾	
		3867/4 TORX® BO 1x TX 10x89; 1x TX 15x89; 1x TX 20x89; 1x TX 25x89; 1x TX 30x89	
		3800/4 1x 1,0x5,5x89	
		3840/4 Hex-Plus 1x 3,0x89; 1x 4,0x89; 1x 5,0x89; 1x 6,0x89	

¹⁾六角形刀片

Kraftform Kompakt 60 · 英制 · 不锈钢



Code	EAN			
05071117001	4013288 115720			1
		●	3816 R 1x 1/4"x119	
		+	3851/4 PH 1x PH 1x89; 1x PH 2x89; 1x PH 3x89 ¹⁾	
		⊕	3867/4 TORX® BO 1x TX 10x89; 1x TX 15x89; 1x TX 20x89; 1x TX 25x89; 1x TX 30x89	
		⊖	3800/4 1x 1,0x5,5x89	
		⊙	3840/4 Hex-Plus 1x 3/32"x89; 1x 1/8"x89; 1x 5/32"x89; 1x 3/16"x89	
		⊠	3868/4 Square-Plus 1x # 1x89; 1x # 2x89; 1x # 3x89	
¹⁾ 六角形刀片				

Kraftform Kompakt 60

89mm批头, 织布包装。17件套。

1个Kraftform 816 R可装卸式伸缩刀杆, 带Rapidaptor快速接头。

独特设计带有的快速接头的手柄能快速换装刀杆, 足以应对多样化的应用。

Kraftform Kompakt 60



Code	EAN			
05059295001	4013288 096289			1
		●	816 R 1x 1/4"x119	
		+	851/4 Z 1x PH 1x89; 1x PH 2x89; 1x PH 3x89 ¹⁾	
		⊕	855/4 Z 1x PZ 1x89; 1x PZ 2x89; 1x PZ 3x89 ¹⁾	
		⊕	867/4 Z TORX® BO 1x TX 10x89; 1x TX 15x89; 1x TX 20x89; 1x TX 25x89; 1x TX 30x89	
		⊖	800/4 Z 1x 1,0x5,5x89	
		⊙	840/4 Z 1x 3,0x89; 1x 4,0x89; 1x 5,0x89; 1x 6,0x89 ¹⁾	
			魔术贴 70 1x 50,0x70,0	
¹⁾ 六角形刀片				



Kraftform Kompakt 60 英制



Code	EAN		
05051042001	156037		1
		816 R 1x 1/4"x119	
		851/4 Z 1x PH 1x89; 1x PH 2x89; 1x PH 3x89 ¹⁾	
		867/4 Z TORX® B0 1x TX 10x89; 1x TX 15x89; 1x TX 20x89; 1x TX 25x89; 1x TX 30x89	
		800/4 Z 1x 1,0x5,5x89	
		840/4 Z 1x 3/32"x89; 1x 1/8"x89; 1x 5/32"x89; 1x 3/16"x89	
		868/4 1x # 1x89; 1x # 2x89; 1x # 3x89	
		魔术贴 70 1x 50,0x70,0	

¹⁾六角形刀片

Kraftform Kompakt 60 KK

- 球头批头可使工具绕轴转动

Kraftform Kompakt 60 KK



Code	EAN		
05059294001	165503		1
		816 R 1x 1/4"x119	
		851/4 Z 1x PH 1x89; 1x PH 2x89; 1x PH 3x89 ¹⁾	
		855/4 Z 1x PZ 1x89; 1x PZ 2x89; 1x PZ 3x89 ¹⁾	
		867/4 TORX® KK 1x TX 10x89; 1x TX 15x89; 1x TX 20x89; 1x TX 25x89; 1x TX 30x89; 1x TX 40x89 ¹⁾	
		842/4 1x 3,0x89; 1x 4,0x89; 1x 5,0x89; 1x 6,0x89	
		魔术贴 70 1x 50,0x70,0	

¹⁾六角形刀片

Kraftform Kompakt 62



Code	EAN		
05059297001	4013288 096302		1
		816 R 1x 1/4"x119	
		851/4 Z 1x PH 1x89; 1x PH 2x89; 1x PH 3x89 ¹⁾	
		855/4 Z 1x PZ 1x89; 1x PZ 2x89; 1x PZ 3x89 ¹⁾	
		867/4 Z TORX® B0 1x TX 8x89; 1x TX 10x89; 1x TX 15x89; 1x TX 20x89; 1x TX 25x89; 1x TX 27x89; 1x TX 30x89; 1x TX 40x89	
		840/4 Z B0 1x 2,0x89; 1x 2,5x89; 1x 3,0x89; 1x 4,0x89; 1x 5,0x89; 1x 6,0x89	
		800/4 Z 1x 1,2x6,5x89	
		871/4 TORQ-SET® Mplus 1x 6x89; 1x 8x89; 1x 10x89	
		875/4 TRI-WING® 1x 1x89; 1x 2x89; 1x 3x89; 1x 4x89	
		857/4 Z 1x 4x89; 1x 6x89; 1x 8x89; 1x 10x89	
		魔术贴 70 1x 50,0x70,0	

¹⁾六角形刀片

自行车工具组套 2

紧凑型13件装紧固工具，不仅适用于自行车应用，外出时携带使用

自行车工具组套 2

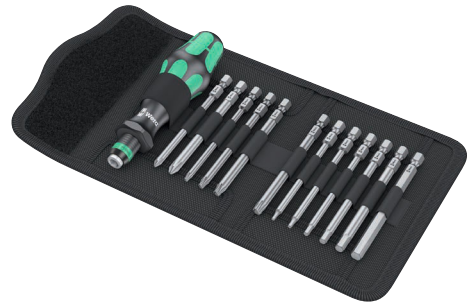

Code	EAN		
05004171001	4013288 211439		1
		816 R 1x 1/4"x119	
		851/4 Z 1x PH 1x89; 1x PH 2x89	
		867/4 Z TORX® 1x TX 10x89; 1x TX 20x89; 1x TX 25x89; 1x TX 30x89	
		840/4 Z 1x 2,0x89; 1x 2,5x89; 1x 3,0x89; 1x 4,0x89; 1x 5,0x89; 1x 6,0x89 ¹⁾	
		魔术贴 70 1x 50,0x70,0	

¹⁾六角形刀片



Kraftform Kompakt 70 通用型

含 816 R Kraftform 批头夹持螺丝刀、Rapidaptor 快速释放夹持和多重材料 Kraftform 手柄的 32 件组套, 减轻疲劳。

Rapidaptor 通用支架, 含强磁性永磁铁, 甚至能固持更大更重的螺丝。共 30 个批头, 便于用户在任何应用作业。含坚固织物盒; 适合 Wera 2go。

- 各类工具置于轻便耐用的帆布袋中, 便于运输
- 可适配 Wera 2go

Kraftform Kompakt 70 通用型



Code	EAN			
05057113001	228345			1
		● 816 R 1x 1/4"x119		
		●● 889/4/1 K 1x 1/4"x50		
		⊕ 851/1 TZ 3x PH 1x25; 3x PH 2x25; 3x PH 3x25		
		⊕ 855/1 TZ 3x PZ 1x25; 3x PZ 2x25; 3x PZ 3x25		
		⊕ 867/1 Z TORX® B0 1x TX 10x25; 1x TX 15x25; 1x TX 20x25; 1x TX 25x25; 1x TX 30x25; 1x TX 40x25		
		○ 840/1 Z 1x 4,0x25; 1x 5,0x25; 1x 6,0x25		
		◐ 800/1 TZ 1x 0,6x4,5x25; 1x 1,0x5,5x25; 1x 1,2x6,5x25		
		9478 1x 160,0x95,0x65,0		
		魔术贴 120 1x 50,0x120,0		

Kraftform Kompakt 71 安全型

- 各类工具置于轻便耐用的帆布袋中, 便于运输
- 可适配 Wera 2go

Kraftform Kompakt 71 安全型



Code	EAN			
05057114001	228352			1
		● 816 R 1x 1/4"x119		
		●● 889/4/1 K 1x 1/4"x50		
		⊕ 867/1 Z TORX® B0 1x TX 7x25; 1x TX 8x25; 1x TX 9x25; 1x TX 10x25; 1x TX 15x25; 1x TX 20x25; 1x TX 25x25; 1x TX 30x25; 1x TX 40x25		
		○ 840/1 Z B0 1x 2,0x25; 1x 2,5x25; 1x 3,0x25; 1x 4,0x25; 1x 5,0x25; 1x 6,0x25		
		◐ 868/1 Z 1x # 0x25; 1x # 1x25; 1x # 2x25; 1x # 3x25		
		⊕ 871/1 TORQ-SET® Mplus 25 mm 1x 6x25; 1x 8x25; 1x 10x25; 1x 1/4"x25		
		⊕ 875/1 TRI-WING® 25 mm 1x 1x25; 1x 2x25; 1x 3x25		
		● 857/1 Z 1x 4x25; 1x 6x25; 1x 8x25; 1x 10x25		
		9478 1x 160,0x95,0x65,0		
		魔术贴 120 1x 50,0x120,0		

Kraftform Kompakt 100

52件套，带表面防护的紧凑而坚固的织布包装，体积小、重量轻，便于携带。包含52把螺丝拆装工具的紧凑型工具组套：1个快速接头合手柄；1Rapidaptor个快速接杆；30个双重抗扭批头（长度25mm），使用寿命更长，具有韧性（BTZ）、通用型，硬度更高（BTH）；12个抗击批头（长度50mm），即使在极端条件下使用其寿命也高于平均水平；8个Hex-Plus六角增强型L型扳手，能有效降低切口效应对螺丝的损伤，长臂球头；极为坚固的布包装，可竖立存放，节省空间，织布材料可保护工具表面。

- 坚固的紧凑型织物包装，保护工具表面
- Rapidaptor技术可快速更换批头
- 25mm双重抗扭批头，使用寿命长
- 50mm长的冲击批头，用于要求特别严苛的作业
- L型扳手，Hex-Plus六角增强型，防止磨圆内六角螺丝头

增强型内六角- 专门针对六角型螺丝的设计

如图可看到和螺槽的接触面积大幅度的增加 因此减少了转位时各个面所承受的压力 从而避免破坏螺丝凹槽的轮廓

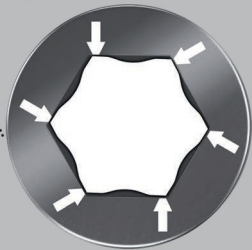

Kraftform Kompakt 100



Code	EAN		
05057460001	4013288 179968		1
		● 813 R 1x 1/4"x90	
		● 889/4/1 K 1x 1/4"x50	
		⊕ 851/1 BTZ 2x PH 1x25; 4x PH 2x25; 2x PH 3x25	
		⊕ 851/4 Impaktor DC 2x PH 2x50; 1x PH 3x50	
		⊕ 855/1 BTH 2x PZ 1x25; 4x PZ 2x25; 2x PZ 3x25	
		⊕ 855/4 Impaktor DC 2x PZ 2x50; 1x PZ 3x50	
		⊕ 867/1 TORX® BTZ 2x TX 10x25; 2x TX 15x25; 3x TX 20x25; 2x TX 25x25; 2x TX 30x25; 1x TX 40x25	
		⊕ 867/4 TORX® Impaktor DC 1x TX 25x50; 1x TX 30x50; 1x TX 40x50	
		● 800/1 BTZ 1x 0,8x5,5x25; 1x 1,0x5,5x25	
		○ 840/4 Impaktor DC 1x 4,0x50; 1x 5,0x50; 1x 6,0x50	
		○ 950 PKS 1x 1,5x50 ¹⁾ ; 1x 2,0x56; 1x 2,5x63; 1x 3,0x71; 1x 4,0x80; 1x 5,0x90; 1x 6,0x100; 1x 8,0x112	
		魔术贴 120 1x 50,0x120,0	

¹⁾ 正六边形

Kraftform Kompakt 400

T型柄螺丝刀:优化的手柄形状确保紧固和松开扭矩的传递。手柄的人体工程学设计使手掌可以完全紧握它,手指可以支托在柔软的球型凹槽内。

整个手部与手柄完全接触,不会产生摩擦损失。表面经特殊处理,让刀具有高抗腐蚀性和精度。

- T型柄螺丝刀,确保紧固或松开时高扭力的传输
- 符合人体工程学的双重材料手柄,手指握柄和舒适的手感,能最大程度传输扭力,缓解作业疲劳
- Rapidaptor-接头技术可快速换装批头
- 带环形磁铁
- 符合ISO 1173-C 6.3和E 6.3标准的1/4" 外六角驱动批头

Kraftform Kompakt 400

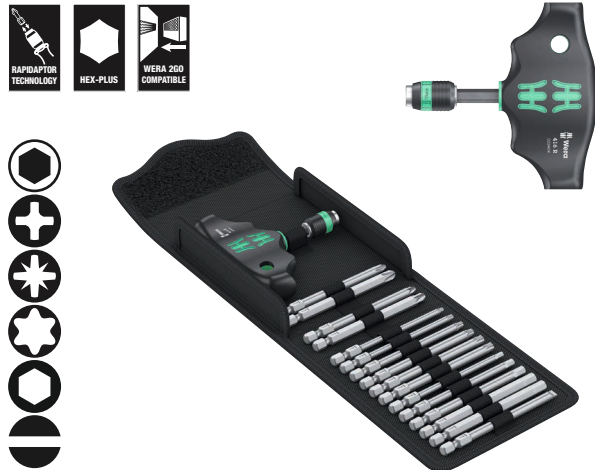

Code	EAN		
05057470001	4013288 214546		1
		416 R 1x 1/4"x45	
		851/4 Z 1x PH 2x89; 1x PH 3x89 ¹⁾	
		855/4 Z 1x PZ 2x89; 1x PZ 3x89 ¹⁾	
		867/4 Z TORX® 1x TX 10x89; 1x TX 15x89; 1x TX 20x89; 1x TX 25x89; 1x TX 30x89; 1x TX 40x89	
		840/4 Z 1x 3,0x89; 1x 4,0x89; 1x 5,0x89; 1x 6,0x89; 1x 8,0x89 ¹⁾	
		800/4 Z 1x 1,0x5,5x89	
		魔术贴 120 1x 50,0x120,0	

¹⁾六角形刀片

Kraftform Kompakt 400 RA 组套 1

17 件组套,含坚固工具袋。一个具有棘轮功能和 Rapidaptor 快速释放夹持的 416 RA T 型柄插换式螺丝刀,适合 1/4" 批头。

带有细齿的集成棘轮 (80齿/回转角4.5°) 可以在无需重新定位工具的情况下放松和加速螺丝刀的驱动。

棘轮机构完全嵌入到手柄中,确保了非常轻松舒适的工作。

单手操作采用转向杆,实现可换向舒适。手柄外形完美贴合手掌,符合人体工学,手指舒适贴合圆形下凹握柄。

整个手掌贴合手柄,避免手掌和手柄之间损失摩擦力。根据 DIN ISO 1173-C 6.3 和 E 6.3 标准,适合安装 1/4"六角驱动批头的批头固持器。

采用Rapidaptor技术实现超快速更换。16 个硬批头,1/4",长 89 mm,通用型。

- 细齿集成棘轮保证快速安全工作
- 棘轮机构完全嵌入手柄,方便工作
- 带快速旋转套筒的快速锁紧螺丝刀,用于快速更换雷电位和高工作速度
- 极高工作速度的快速旋转套筒
- 符合人体工程学的双重材料手柄,手指握柄和舒适的手感,能最大程度传输扭力,缓解作业疲劳
- 符合ISO 1173-C 6.3和E 6.3标准的1/4" 外六角驱动批头

Kraftform Kompakt 400 RA 组套 1



Code	EAN		
05023471001	4013288 222879		1
		416 RA 1x 1/4"x45	
		851/4 Z 1x PH 2x89; 1x PH 3x89 ¹⁾	
		855/4 Z 1x PZ 2x89; 1x PZ 3x89 ¹⁾	
		867/4 Z TORX® 1x TX 10x89; 1x TX 15x89; 1x TX 20x89; 1x TX 25x89; 1x TX 30x89; 1x TX 40x89	
		840/4 Z 1x 3,0x89; 1x 4,0x89; 1x 5,0x89; 1x 6,0x89 ¹⁾ ; 1x 8,0x89 ¹⁾	
		800/4 Z 1x 1,0x5,5x89	
		魔术贴 120 1x 50,0x120,0	

¹⁾六角形刀片

Kraftform Kompakt 400 RA 组套 Imperial 1



Code	EAN		
05057473001	4013288 222930		1
		● 416 RA 1x 1/4"x45	
		⊕ 851/4 Z 1x PH 2x89; 1x PH 3x89 ¹⁾	
		⊗ 867/4 Z TORX® 1x TX 10x89; 1x TX 15x89; 1x TX 20x89; 1x TX 25x89; 1x TX 30x89; 1x TX 40x89	
		○ 840/4 Z 1x 1/8"x89; 1x 5/32"x89; 1x 3/16"x89; 1x 7/32"x89; 1x 1/4"x89	
		□ 868/4 1x # 2x89; 1x # 3x89	
		● 800/4 Z 1x 1,0x5,5x89	
		魔术贴 120 1x 50,0x120,0	

¹⁾六角形刀片

Kraftform Kompakt 400 RA 组套 2

9 件组套, 含坚固工具袋。一个具有棘轮功能的 411 A RA T 型柄螺丝刀适配器, 1/4" 套筒。

带有细齿的集成棘轮 (80齿/回转角4.5°) 可以在无需重新定位工具的情况下放松和加速螺丝刀的驱动。

棘轮机构完全嵌入到手柄中, 确保了非常轻松舒适的工作。

单手操作采用转向杆, 实现可换向向舒适。手柄外形完美贴合手掌, 符合人体工学, 手指舒适贴合圆形下凹握柄。

整个手掌贴合手柄, 避免手掌和手柄之间损失摩擦力。带方头驱动的 1/4" 套筒和 1/4" 插件; 含球锁。

8 件 Zyklop 套筒, 带 1/4" 驱动。“易寻”色标系统: 根据尺寸进行颜色编码, 可快速方便地找到所需工具。

- 符合人体工程学的双重材料手柄, 手指握柄和舒适的手感, 能最大程度传输扭力, 缓解作业疲劳
- 细齿集成棘轮保证快速安全工作
- 方便改变顺时针/逆时针方向的转向杆
- 棘轮机构完全嵌入手柄, 方便工作
- 极高工作速度的快速旋转套筒
- 带固定球锁的 1/4" 套筒安装架
- 带“易寻”色标系统, 可轻松找到所需套筒



Kraftform Kompakt 400 RA 组套 2



Code	EAN		
05023470001	4013288 222862		1
		○ 411 A RA 1x 1/4"x45	
		● 8790 HMA 1x 6,0x23,0; 1x 7,0x23,0; 1x 8,0x23,0; 1x 9,0x23,0; 1x 10,0x23,0; 1x 11,0x23,0; 1x 12,0x23,0; 1x 13,0x23,0	
		魔术贴 120 1x 50,0x120,0	

Kraftform Kompakt 400 RA 组套 Imperial 2



Code	EAN		
05057474001	4013288 223364		1
		□ 411 A RA 1x 1/4"x45	
		● 8790 HMA 1x 3/16"x23,0; 1x 7/32"x23,0; 1x 1/4"x23,0; 1x 9/32"x23,0; 1x 5/16"x23,0; 1x 3/8"x23,0; 1x 7/16"x23,0; 1x 1/2"x23,0	
		魔术贴 120 1x 50,0x120,0	

Kraftform Kompakt 400 RA SHK 组套 1

- 专为暖通应用设置

Kraftform Kompakt 400 RA SHK 组套 1



Code	EAN		
05136072001	4013288 228369		1
		● 416 RA 1x 1/4"x45	
		● 816 R 1x 1/4"x119	
		⊕ 851/4 Z 1x PH 2x89	
		⊕ 855/4 Z 1x PZ 2x89	
		⊕ 855/4 PZ/S 1x # 1x70; 1x # 2x70	
		⊕ 867/4 Z TORX® 1x TX 15x89; 1x TX 20x89; 1x TX 25x89; 1x TX 30x89	
		○ 840/4 Z 1x 2,0x89; 1x 2,5x89; 1x 3,0x89; 1x 4,0x89; 1x 5,0x89; 1x 6,0x89 ¹⁾ ;	
		● 869/4 M 1x 8,0x50,0; 1x 10,0x50,0	
		魔术贴 120 1x 50,0x120,0	

¹⁾ 六角形刀片

Kraftform Kompakt 900 组套 1

冲击螺丝刀 921 结合了手动冲击扳手、紧凑工具和螺丝刀与磅推力刀杆的优势。冲击扳手功能的松弛扭矩可达 25 Nm。

坚固的批头固持器可为各种螺旋型材安装不同的专用批头。磅推力刀杆可确保完整的功率传输（零损失）。冲击扳手功能和螺丝刀功能可按要求切换。

- 刀杆螺丝刀组套紧凑牢固，带有手动活化冲击扳手功能
- 松紧螺丝连接处
- 锤击冲击波转化为旋转运动，松弛扭矩约为 25 Nm – 无磅推力刀杆损耗
- 可逆功能：冲击扳手及螺丝刀
- 采用 1/4" 外六角驱动特殊硬化特硬批头
- 结合了手动冲击扳手、紧凑工具和螺丝刀与磅推力刀杆的优势

Kraftform Kompakt 900 组套 1



Code	EAN		
05018110001	4013288 222176		1
		● 921 1x 1/4"x163,5	
		⊕ 851 S 1x PH 1x70; 1x PH 2x70; 1x PH 3x70	
		⊕ 855 S 1x PZ 1x70; 1x PZ 2x70; 1x PZ 3x70	
		⊕ 867 S TORX® 1x TX 15x70; 1x TX 20x70; 1x TX 25x70; 1x TX 30x70; 1x TX 40x70	
		○ 840 S Hex-Plus 1x 3,0x70; 1x 4,0x70; 1x 5,0x70; 1x 6,0x70	
		◐ 800 S 1x 0,8x4,0x70; 1x 1,0x5,5x70; 1x 1,2x6,5x70	
		魔术贴 120 1x 50,0x120,0	

Kraftform Kompakt 900 Imperial 组套 1



Code	EAN		
05018111001	4013288 222312		1
		● 921 1x 1/4"x163,5	
		⊕ 851 S 1x PH 1x70; 1x PH 2x70; 1x PH 3x70	
		⊕ 867 S TORX® 1x TX 15x70; 1x TX 20x70; 1x TX 25x70; 1x TX 30x70; 1x TX 40x70	
		○ 840 S Hex-Plus 1x 1/8"x70; 1x 5/32"x70; 1x 3/16"x70; 1x 1/4"x70	
		○ 868 S 1x # 1x70; 1x # 2x70; 1x # 3x70	
		◐ 800 S 1x 0,8x4,0x70; 1x 1,0x5,5x70; 1x 1,2x6,5x70	
		魔术贴 120 1x 50,0x120,0	

921 Kraftform Plus 冲击螺丝刀 - 900系列

冲击螺丝刀 921 结合了手动冲击扳手、紧凑工具和螺丝刀与磅推力刀杆的优势。

冲击扳手功能的松弛扭矩可达 25 Nm。

坚固的批头固持器可为各种螺旋型材安装不同的专用批头。磅推力刀杆可确保完整的功率传输 (零损失)。

冲击扳手功能和螺丝刀功能可按要求切换。

- 松紧螺丝连接处
- 手动冲击扳手功能可开关
- 锤击冲击波转化为旋转运动, 松弛扭矩约为25 Nm – 无磅推力刀杆损耗
- 可逆功能: 冲击扳手及螺丝刀

921 Kraftform Plus 冲击螺丝刀 - 900系列



Code	EAN	批头	长度	长度	重量	数量
05018100001	221698	1/4"	163,5	6 7/16"		1

851 S 冲击螺丝刀十字批头

适合Phillips-Recess十字头螺丝的特硬批头。这可以防止批头过早断裂并延长其使用寿命。

适用于 Wera 冲击螺丝刀 921。使用 1/4" 的六角形驱动。

- 用于十字螺丝
- 耐久性极强
- 1/4"六角驱动
- 用于 Wera 冲击螺丝刀 921

851 S 冲击螺丝刀十字批头



Code	EAN	批头	长度	长度	重量	数量
05018160001	222510	PH 1	70	2 3/4"		5
05018161001	222527	PH 2	70	2 3/4"		5
05018162001	222534	PH 3	70	2 3/4"		5

855 S PZ 米字冲击螺丝刀批头

适用于PZ米字螺丝的特硬批头。这可以防止批头过早断裂并延长其使用寿命。适用于 Wera 冲击螺丝刀 921。

使用 1/4" 的六角形驱动。

- 用于米字螺丝
- 耐久性极强
- 1/4"六角驱动
- 用于 Wera 冲击螺丝刀 921

855 S PZ 米字冲击螺丝刀批头



Code	EAN	批头	长度	长度	重量	数量
05018163001	222541	PZ 1	70	2 3/4"		5
05018164001	222558	PZ 2	70	2 3/4"		5
05018165001	222565	PZ 3	70	2 3/4"		5

867 S TORX® 冲击螺丝刀批头

特硬批头, 用于 TORX® 套筒螺丝。这可以防止批头过早断裂并延长其使用寿命。

适用于 Wera 冲击螺丝刀 921。使用 1/4" 的六角形驱动。

- 用于TORX®梅花螺丝
- 耐久性极强
- 1/4"六角驱动
- 用于 Wera 冲击螺丝刀 921

867 S TORX® 冲击螺丝刀批头

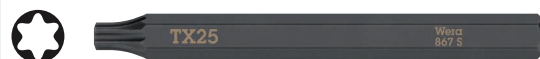

Code	EAN	批头	长度	长度	重量	数量
05018166001	222572	TX 15	70	2 3/4"		5
05018167001	222589	TX 20	70	2 3/4"		5
05018168001	222596	TX 25	70	2 3/4"		5
05018169001	222602	TX 30	70	2 3/4"		5
05018170001	222619	TX 40	70	2 3/4"		5

增强型内六角- 专门针对六角型螺丝的设计

如图可看到和螺槽的接触面积大幅度的增加 因此减少了
转位时各个面所承受的压力 从而避免破坏螺丝凹槽的轮廓

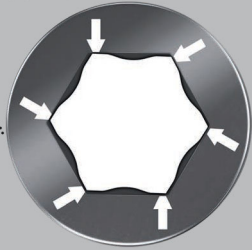

特硬批头, 用于六角螺帽栓。这可以防止批头过早断裂并延长其使用寿命。适用于 Wera 冲击螺丝刀 921。

使用 1/4" 的六角形驱动。

- 用于套筒头螺丝
- 耐久性极强
- Hex-Plus六角增强型可延长螺丝头的寿命
- 1/4"六角驱动
- 用于 Wera 冲击螺丝刀 921

840 S Hex-Plus 冲击螺丝刀批头

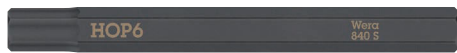

	EAN						
Code	4013288	mm		mm			
05018150001	222428	3,0		70	2 3/4"		5
05018151001	222435	4,0		70	2 3/4"		5
05018152001	222442	5,0		70	2 3/4"		5
05018153001	222459	6,0		70	2 3/4"		5
05018154001	222466		1/8"	70	2 3/4"		5
05018155001	222473		5/32"	70	2 3/4"		5
05018156001	222480		3/16"	70	2 3/4"		5
05018157001	222497		1/4"	70	2 3/4"		5

800 S 冲击螺丝刀一字批头

特硬批头, 用于一字螺丝。这可以防止批头过早断裂并延长其使用寿命。

适用于 Wera 冲击螺丝刀 921。使用 1/4" 的六角形驱动。

- 用于一字螺丝
- 耐久性极强
- 1/4"六角驱动
- 用于 Wera 冲击螺丝刀 921

800 S 冲击螺丝刀一字批头



	EAN						
Code	4013288	mm	mm	mm			
05018140001	222398	0,8	4,0	70	2 3/4"		5
05018141001	222404	1,0	5,5	70	2 3/4"		5
05018142001	222411	1,2	6,5	70	2 3/4"		5

868 S 冲击螺丝刀方头套筒

特硬批头, 用于内四角套筒螺丝。这可以防止批头过早断裂并延长其使用寿命。

适用于 Wera 冲击螺丝刀 921。使用 1/4" 的六角形驱动。

- 适用于内四角螺丝
- 耐久性极强
- 1/4"六角驱动
- 用于 Wera 冲击螺丝刀 921

868 S 冲击螺丝刀方头套筒



	EAN					
Code	4013288		mm			
05018171001	222626	# 1	70	2 3/4"		5
05018172001	222633	# 2	70	2 3/4"		5
05018173001	222640	# 3	70	2 3/4"		5

Kraftform Kompakt 838 RA S Set 1

14 件棘轮螺丝刀组套。带直观棘轮功能的批头夹持螺丝刀。转动工具可以加快工作速度。棘轮机构完全嵌入到手柄中，确保了非常轻松不费力的工作。人体工程学切换到顺时针/逆时针或位置 0。

Kraftform Plus 手柄，符合人体工学设计的旋拧操作，可避免出现起泡和老茧。采用 1/4" 外六角驱动批头的磁性批头夹持螺丝刀。

13 个通用的硬批头（十字螺丝和 PZ 米字螺丝、TORX® 螺丝、内六角螺丝和一字螺丝），50 mm 长；化学镀镍，部分带有“Take it easy”工具查找装置：用特定颜色代表不同端头种类和尺寸，有助于快速查找所需批头。

- 用于 1/4" 外六角驱动批头的极小批头夹持螺丝刀
- 集成到手柄上的棘轮机构
- 细齿集成棘轮保证快速安全工作
- 高工作速度：棘轮机构也可用于在旋拧时“旋转”
- 符合人体工程学的直观切换到顺时针/逆时针或位置 0
- 批头支座中的强磁性永磁体牢牢固定住批头
- “易寻”色标系统：用特定的颜色代表不同端头种类和尺寸
- 可以和其他 Wera 2go 系列产品组合使用

Kraftform Kompakt 838 RA S Set 1



Code	EAN		
05051060001	4013288 229755		1
		● 838 RA S 1x 1/4"x102	
		⊕ 851/4 BTZ 1x PH 1x50; 1x PH 2x50	
		⊕ 855/4 BTZ 1x PZ 1x50; 1x PZ 2x50	
		⊕ 867/4 TORX® BTZ 1x TX 10x50; 1x TX 15x50; 1x TX 20x50; 1x TX 25x50	
		○ 840/4 BTZ 1x 2,5x50; 1x 3,0x50; 1x 4,0x50; 1x 5,0x50	
		◐ 800/4 BTZ 1x 0,8x5,5x50	
		魔术贴 70 1x 50,0x70,0	

Kraftform Kompakt 838 RA S Imperial Set 1



Code	EAN		
05051065001	4013288 229816		1
		● 838 RA S 1x 1/4"x102	
		⊕ 851/4 BTZ 1x PH 1x50; 1x PH 2x50	
		⊕ 867/4 TORX® BTZ 1x TX 10x50; 1x TX 15x50; 1x TX 20x50; 1x TX 25x50	
		○ 840/4 Z 1x 3/64"x50; 1x 5/32"x50; 1x 3/16"x50; 1x 7/32"x50	
		◐ 800/4 BTZ 1x 0,8x5,5x50	
		◑ 868/4 1x # 1x50; 1x # 2x50	
		魔术贴 70 1x 50,0x70,0	

Kraftform Kompakt 838 RA-R M Set 1

15 件棘轮螺丝刀组套。带直观棘轮功能的批头夹持螺丝刀。手柄 (36 齿/回转角 10°) 集成细齿棘轮机构可以在无需重新定位工具的情况下放松和加速螺丝刀的驱动。“旋转”工具也是可能的。棘轮机构完全嵌入到手柄中，确保了非常轻松舒适的工作。人体工程学切换到顺时针/逆时针或位置 0。Kraftform Plus 手柄，符合人体工学设计的舒适旋拧操作舒适，可避免出现起泡和老茧。

适用于符合 DIN ISO 1173-C 6.3 和 E 6.3 (ISO 1173) 要求的带 1/4" 外六角驱动批头的磁性批头夹持螺丝刀。Rapidaptor 快速释放夹持可超快速更换批头，无需任何额外工具。强磁性磁铁固定批头绝对稳固。

13 个通用的硬批头 (十字螺丝和 PZ 米字螺丝、TORX® 螺丝、一字螺丝和内六角螺丝)，89 mm 长；化学镀镍。

- 带 Rapidaptor 快速释放卡盘的批头夹持螺丝刀，适用于符合 DIN ISO 1173-C 6.3 和 E 6.3 要求的带 1/4" 外六角驱动批头，以及 Wera 连接系列 1 和 4
- 快速接杆可快速更换批头
- 采用经久耐用的折叠袋，兼容 Wera 2go

Kraftform Kompakt 838 RA-R M Set 1



Code	EAN		
05051061001	4013288 229779		1
		● 838 RA-R M 1x 1/4"x123,5	
		⊕ 851/4 Z 1x PH 1x89; 1x PH 2x89; 1x PH 3x89 ¹⁾	
		⊕ 855/4 Z 1x PZ 1x89; 1x PZ 2x89; 1x PZ 3x89 ¹⁾	
		⊛ 867/4 Z TORX® 1x TX 10x89; 1x TX 15x89; 1x TX 20x89; 1x TX 25x89	
		○ 840/4 Z 1x 3,0x89; 1x 4,0x89; 1x 5,0x89	
		◐ 800/4 Z 1x 1,0x5,5x89	
		魔术贴 70 1x 50,0x70,0	

¹⁾六角形刀片

Kraftform Kompakt 838 RA-R M Imperial Set 1



Code	EAN		
05051066001	4013288 229823		1
		● 838 RA-R M 1x 1/4"x123,5	
		⊕ 851/4 Z 1x PH 1x89; 1x PH 2x89; 1x PH 3x89 ¹⁾	
		⊕ 867/4 Z TORX® 1x TX 10x89; 1x TX 15x89; 1x TX 20x89; 1x TX 25x89	
		○ 840/4 Z 1x 1/8"x89; 1x 5/32"x89; 1x 3/16"x89	
		◐ 800/4 Z 1x 1,0x5,5x89	
		○ 868/4 1x # 1x89; 1x # 2x89; 1x # 3x89	
		魔术贴 70 1x 50,0x70,0	

¹⁾六角形刀片

Kraftform Kompakt 迷你 一体式迷你螺丝刀 RA 1

特别是批头接头较短的小型批头手动固定座, 适用于难以到达的区域。

配棘轮功能和细齿, 回转角小。易操作拨杆 (右、紧、左)。

含 6 件坚固的通用型批头, 置于手柄的一体式迷你螺丝刀内。批头接头中强有力的永磁体确保批头的牢固性。

双重材料 Kraftform 手柄, 结合硬质区和软质区, 具有实用性, 适合紧握和精密作业。

“易寻”色标系统: 用特定颜色代表不同刀头种类和尺寸, 有助于快速查找所需批头。

- Stubby 的形状简短、紧凑, 适合在狭小的安装空间内工作, 带内建批头仓中的 6 个批头
- 符合人体工程学的双重材料 Kraftform 手柄提升作业精确度
- 棘轮功能, 配细齿, 回转角小, 拨杆 (右、紧、左)
- 可旋转并内藏批头库, 便于批头的拆卸和安全存放
- “易寻”色标系统: 用特定的颜色代表不同端头种类和尺寸

Kraftform Kompakt 迷你 一体式迷你螺丝刀 RA 1

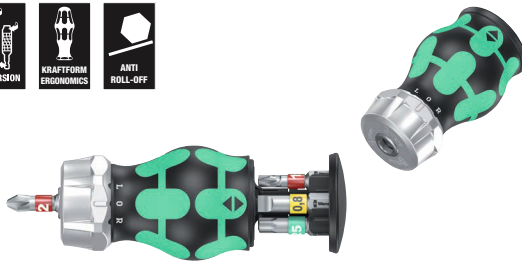

Code	EAN		
05008883001	221124		1
		⊕ 851/1 BTZ PH 1x PH 1x25; 1x PH 2x25	
		⊗ 867/1 TORX® BTZ 1x TX 15x25; 1x TX 20x25; 1x TX 25x25	
		● 800/1 BTZ 1x 0,8x5,5x25	

¹ 停产。新版预定于2025年6月1日推出。

Kraftform Kompakt 迷你 一体式迷你螺丝刀 RA 2



Code	EAN		
05008884001	221131		1
		⊕ 851/1 BTZ PH 1x PH 1x25; 1x PH 2x25	
		⊕ 855/1 BTZ PZ 1x PZ 1x25; 1x PZ 2x25	
		⊗ 867/1 TORX® BTZ 1x TX 25x25	
		● 800/1 BTZ 1x 0,8x5,5x25	

¹ 停产。新版预定于2025年6月1日推出。

Kraftform Kompakt 迷你 一体式迷你螺丝刀 RA 4

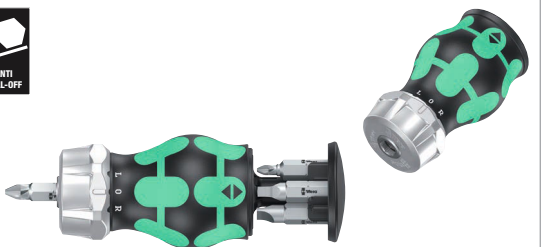

Code	EAN		
05008886001	221155		1
		⊕ 851/1 Z PH 1x PH 1x25; 1x PH 2x25	
		□ 868/1 Z 1x # 1x25; 1x # 2x25	
		● 800/1 Z 1x 1,0x5,5x25; 1x 1,2x6,5x25	

¹ 停产。新版预定于2025年6月1日推出。

Kraftform Kompakt Stubby 插换式迷你螺丝刀柄 · 内建批头库

特别是批头支座较短的小型批头手动接头, 适用于难以到达的区域。包括 6 个批头, 位于手柄中的批头库中。

Kraftform Kompakt Stubby 总长仅65mm, 可谓一个真正的迷你旋拧操作车间。批头支座中强有力的永磁体确保批头的牢固性。

多材质手柄和硬质区和软质区的实用组合可提高握持的牢固性和加工的精密性。

“Take it easy” 易寻系统: 可根据按照输出设定的尺寸冲压和彩色编码, 方便查找所需批头。

- Stubby 的形状简短、紧凑, 适合在狭小的安装空间内工作, 带内建批头仓中的 6 个批头
- 符合人体工程学的双重材料 Kraftform 手柄提升作业精确度
- 1/4" 批头接头, 带磁性
- 可旋转并内藏批头库, 便于批头的拆卸和安全存放
- “易寻”色标系统: 用特定的颜色代表不同端头种类和尺寸

Kraftform Kompakt Stubby 插换式迷你螺丝刀柄 · 内建批头库 1

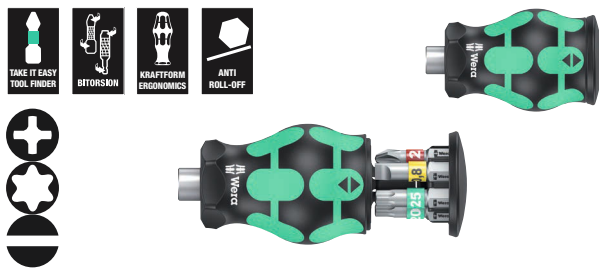

Code	EAN		
05008873001	4013288 217769		1
		+	851/1 BTZ PH 1x PH 1x25; 1x PH 2x25
		⊕	867/1 TORX® BTZ 1x TX 15x25; 1x TX 20x25; 1x TX 25x25
		⊖	800/1 BTZ 1x 0,8x5,5x25

Kraftform Kompakt Stubby 插换式迷你螺丝刀柄 · 内建批头库 2

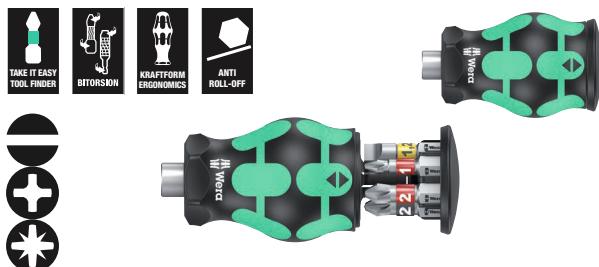

Code	EAN		
05008874001	4013288 217776		1
		⊖	800/1 BTZ 1x 0,8x5,5x25; 1x 1,2x6,5x25
		+	851/1 BTZ PH 1x PH 1x25; 1x PH 2x25
		⊕	855/1 BTZ PZ 1x PZ 1x25; 1x PZ 2x25

Kraftform Kompakt Stubby 插换式迷你螺丝刀柄 · 内建批头库 3

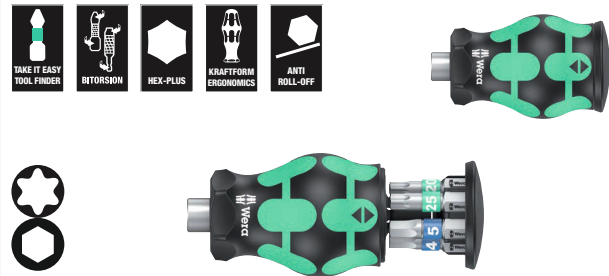

Code	EAN		
05008875001	4013288 217783		1
		⊕	867/1 TORX® BTZ 1x TX 15x25; 1x TX 20x25; 1x TX 25x25
		⊖	840/1 BTZ Hex-Plus 1x 3,0x25; 1x 4,0x25; 1x 5,0x25

Kraftform Kompakt Stubby 插换式迷你螺丝刀柄 · 内建批头库 4

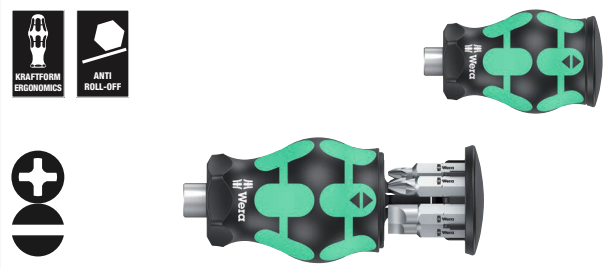

Code	EAN		
05008877001	4013288 219800		1
		+	851/1 Z PH 1x PH 1x25; 1x PH 2x25; 1x PH 3x25
		⊖	800/1 Z 1x 0,6x4,5x25; 1x 1,0x5,5x25; 1x 1,2x6,5x25

Kraftform Kompakt Stubby 插换式迷你螺丝刀柄 · 内建批头库 5

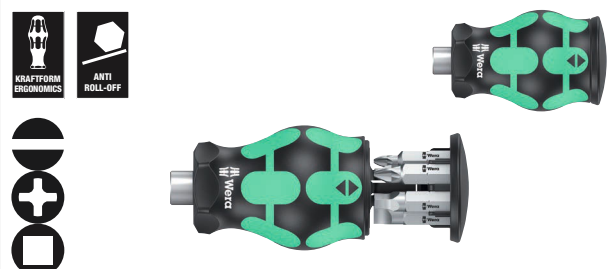

Code	EAN		
05008878001	4013288 219817		1
		⊖	800/1 Z 1x 1,0x5,5x25; 1x 1,2x6,5x25
		+	851/1 Z PH 1x PH 1x25; 1x PH 2x25
		⊖	868/1 Z 1x # 1x25; 1x # 2x25

Kraftform Kompakt Stubby 1

手柄/可替换刀杆系统,可瞬时快速更换所需刀杆。带短刀杆的超小款 Stubby 刀柄,适合在难以够到的区域使用。

适用于安装符合 DIN ISO 1173-C 6.3标准的 1/4"六角驱动批头以及 Wera 系列1。

采用具有强磁性的永磁铁,大型厚重螺钉也能固持。双组件式强力手柄,采用硬质和软质区的实用组合设计,可牢固抓握并精准作业。

高品质 BiTorsion 双重抗扭批头带 BiTorsion 区域,可防止批头的尖部在高强度作业下出现扭曲。产品使用寿命由此得到显著提升。

紧凑型织布盒,牢固耐用、重量轻、体积小。适合作为 Wera 2go 系列产品的底座。

- 独特设计的快速手柄能快速换装刀杆
- Stubby 批头手柄小巧设计适合狭小空间内作业
- 符合人体工程学的双重材料 Kraftform 手柄提升作业精确度
- 带有BiTorsion区的批头,缓解负荷峰值下的所承载的扭力
- “易寻”色标系统:用特定的颜色代表不同端头种类和尺寸

Kraftform Kompakt Stubby 1



Code	EAN		
05057471001	4013288 214553		1
		● 811/1 Stubby 1x 1/4"	
		⊕ 851/1 BTZ 1x PH 1x25; 1x PH 2x25	
		⊕ 855/1 BTZ 1x PZ 1x25; 1x PZ 2x25	
		⊕ 867/1 TORX® BTZ 1x TX 10x25; 1x TX 15x25; 1x TX 20x25; 1x TX 25x25; 1x TX 30x25	
		○ 840/1 BTZ 1x 2,0x25; 1x 2,5x25; 1x 3,0x25; 1x 4,0x25; 1x 5,0x25; 1x 5,5x25	
		◐ 800/1 BTZ 1x 0,8x5,5x25; 1x 1,0x5,5x25; 1x 1,2x6,5x25	
		魔术贴 70 1x 50,0x70,0	

自行车组套 11

Stubby 一体式迷你螺丝刀, 便于摩托车快速作业。特别是批头接头较短的小型批头手动固定座, 适用于难以到达的区域。含 7 件不锈钢批头, 其中 6 件在一体式迷你螺丝刀内的手柄上, 1 件在接头。

双重材料 Kraftform 手柄, 结合硬质区和软质区, 具有实用性, 适合紧握和精密作业。

“易寻”色标系统: 用特定颜色代表不同刀头种类和尺寸, 有助于快速查找所需批头。

- 紧缩式 Stubby 形状, 用于狭窄空间作业, 含 7 个批头
- 符合人体工程学的双重材料 Kraftform 手柄提升作业精确度
- 不锈钢批头
- 可旋转并内藏批头库, 便于批头的拆卸和安全存放
- “易寻”色标系统: 用特定的颜色代表不同端头种类和尺寸

自行车组套 11

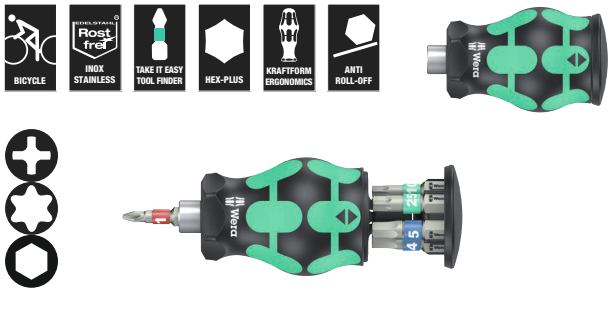

Code	EAN		
05004179001	4013288 220714		1
		+	3851/1 TS PH 1x PH 1x25
		⊗	3867/1 TS TORX® 1x TX 10x25; 1x TX 25x25
		○	3840/1 TS 1x 2,5x25; 1x 3,0x25; 1x 4,0x25; 1x 5,0x25

自行车组套 5

特别是批头接头较短的小型批头手动固定座, 适用于难以到达的区域。配棘轮功能和细齿, 回转角小。易操作拨杆 (右、紧、左)。

含 7 件不锈钢批头, 其中 6 件在一体式迷你螺丝刀内的手柄上, 1 件在接头。批头接头中强有力的永磁体确保批头的牢固性。

双重材料 Kraftform 手柄, 结合硬质区和软质区, 具有实用性, 适合紧握和精密作业。

“易寻”色标系统: 用特定颜色代表不同刀头种类和尺寸, 有助于快速查找所需批头。

- 紧缩式 Stubby 形状, 配一体式迷你螺丝刀, 用于狭窄空间作业, 含 7 个不锈钢批头
- 符合人体工程学的双重材料 Kraftform 手柄提升作业精确度
- 棘轮功能, 配细齿, 回转角小, 拨杆 (右、紧、左)
- 可旋转并内藏批头库, 便于批头的拆卸和安全存放
- “易寻”色标系统: 用特定的颜色代表不同端头种类和尺寸

自行车组套 5

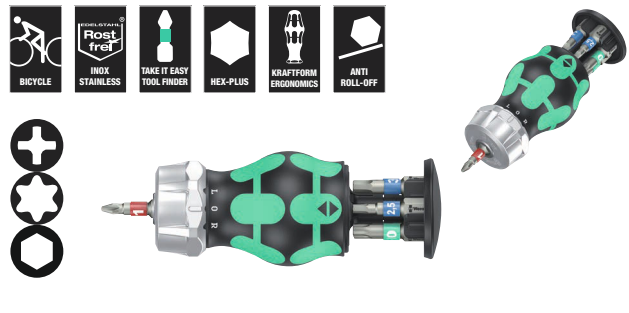

Code	EAN		
05004185001	4013288 221162		1
		+	3851/1 TS PH 1x PH 1x25
		⊗	3867/1 TS TORX® 1x TX 10x25; 1x TX 25x25
		○	3840/1 TS 1x 2,5x25; 1x 3,0x25; 1x 4,0x25; 1x 5,0x25

¹⁾ 停产。新版预定于2025年6月1日推出。

Kraftform Kompakt W 1 安装维护

包含41种最常用的螺丝拧紧工具的紧凑型工具组套, 用于包括木制品的作业。包括牢固的Zyklus Mini棘轮扳手, 带有延长杆、套筒和接头; 8个手动-动力工具套筒, 规格从5.5-13mm; 1个 816 RA手柄, 带棘轮功能、细齿设计使得小角度也可以扭转、切换装置(右-固定-左), 最大扭矩50Nm并且具有Rapidaptor的快速接头技术; 1个通用螺丝批手柄; 6个25mm长的批头; 16个89 mm长的批头; 5个麻花钻, 规格是3-8mm, 用于木制品作业; 1个螺钉钳子, 用于牢固地固定螺钉; 1个电压测试器247; 织物包十分坚固耐用; 可置于车间货架存放, 方便整洁; 纺织材质增加了外表面的保护作用; 轻便的设计便于携带。

- 极为快速的 $\frac{1}{4}$ " Zyklus Speed棘轮扳手, 可自由转动的棘轮头, 带5种预设的锁定位置
- 手动和(非冲击)电动工具套筒, 带球锁, 尾部滚花以便于手指握持
- JOKER双头开口扳手, 带固持功能、限位挡块、小回转角和超细齿
- Kraftform绝缘接杆和可更换式刀杆
- VDE 刀杆(长 157 mm) 具有实用的旋转功能、防侧倾保护和“Take it easy”工具查找装置: 带有侧面彩色编码和激光雕刻尺寸指示
- 坚固的织物盒包装

Kraftform Kompakt W 1 安装维护



Code	EAN		
	4013288		
05135926001	178336		1
		817 VDE 1x 9x98	
		Kraftform Kompakt VDE 60 i Take it easy 1x 0,4x2,5x157	
		Kraftform Kompakt VDE 60 iS Take it easy 1x 0,6x3,5x157; 1x 0,8x4,0x157; 1x 1,0x5,5x157	
		Kraftform Kompakt VDE 62 iS Take it easy 1x PH 1x157; 1x PH 2x157	
		Kraftform Kompakt VDE 65 iS Take it easy 1x PZ 1x157; 1x PZ 2x157	
		Kraftform Kompakt VDE 67 i TORX® Take it easy 1x TX 10x157	
		Kraftform Kompakt VDE 67 iS TORX® Take it easy 1x TX 15x157; 1x TX 20x157; 1x TX 25x157	
		1440 1x 4,5-6,0x41,0	
		247 1x 0,5x3,0x70	
		6002 Joker Double 1x 10x13x167	
		8000 A 1x $\frac{1}{4}$ "x152,0	
		8784 A1 1x $\frac{1}{4}$ "x $\frac{1}{4}$ "x37,0	
		8794 SA 1x $\frac{1}{4}$ "x75,0	
		8790 HMA 1x 5,5x23,0; 1x 6,0x23,0; 1x 7,0x23,0; 1x 8,0x23,0; 1x 10,0x23,0; 1x 11,0x23,0; 1x 12,0x23,0; 1x 13,0x23,0	
		893/4/1 K 1x $\frac{1}{4}$ "x50	
		855/1 Z 1x PZ 1x25; 1x PZ 2x25	
		840/1 Z 1x 3,0x25; 1x 4,0x25; 1x 5,0x25; 1x 6,0x25	
		867/1 TORX® 1x TX 25x25	
		魔术贴 240 1x 50,0x240,0	

^{*)} 未在美国和加拿大上市

Kraftform Kompakt W 2 安装维护



Code	EAN		
05135870001	4013288 209542		1
		817 VDE 1x 9x98	
		Kraftform Kompakt VDE 60 i Take it easy 1x 0,4x2,5x157	
		Kraftform Kompakt VDE 60 iS Take it easy 1x 0,6x3,5x157; 1x 0,8x4,0x157; 1x 1,0x5,5x157	
		Kraftform Kompakt VDE 62 iS Take it easy 1x PH 1x157; 1x PH 2x157	
		Kraftform Kompakt VDE 67 i TORX® Take it easy 1x TX 10x157	
		Kraftform Kompakt VDE 67 iS TORX® Take it easy 1x TX 15x157; 1x TX 20x157; 1x TX 25x157	
		Kraftform Kompakt VDE 65 iS Take it easy 1x PZ 1x157; 1x PZ 2x157	
		1440 1x 4,5-6,0x41,0	
		335 1x 0,4x2,5x60 ¹⁾	
		6002 Joker Double 1x 10x13x167	
		8000 A 1x 1/4"x152,0	
		8784 A1 1x 1/4"x1/4"x37,0	
		8794 SA 1x 1/4"x75,0	
		8790 HMA 1x 5,5x23,0; 1x 6,0x23,0; 1x 7,0x23,0; 1x 8,0x23,0; 1x 10,0x23,0; 1x 11,0x23,0; 1x 12,0x23,0; 1x 13,0x23,0	
		893/4/1 K 1x 1/4"x50	
		851/1 Z 1x PH 1x25; 1x PH 2x25	
		840/1 Z 1x 3,0x25; 1x 4,0x25; 1x 5,0x25; 1x 6,0x25	
		867/1 TORX® 1x TX 25x25	
		魔术贴 240 1x 50,0x240,0	

¹⁾ 不带Lasertip激光蚀刻刀头

Kraftform Kompakt W Imperial 1 安装维护



Code	EAN		
05135871001	4013288 209559		1
		817 VDE 1x 9x98	
		Kraftform Kompakt VDE 60 i Take it easy 1x 0,4x2,5x157	
		Kraftform Kompakt VDE 60 iS Take it easy 1x 0,6x3,5x157; 1x 0,8x4,0x157; 1x 1,0x5,5x157	
		Kraftform Kompakt VDE 62 iS Take it easy 1x PH 1x157; 1x PH 2x157	
		Kraftform Kompakt VDE 67 i TORX® Take it easy 1x TX 10x157	
		Kraftform Kompakt VDE 67 iS TORX® Take it easy 1x TX 15x157; 1x TX 20x157; 1x TX 25x157	
		Kraftform Kompakt VDE 68 iS Take it easy 1x # 1x157; 1x # 2x157	
		335 1x 0,4x2,5x60 ¹⁾	
		1440 1x 4,5-6,0x41,0	
		6000 Joker Imperial 1x 1/2"x177	
		8000 A 1x 1/4"x152,0	
		8790 HMA 1x 7/32"x23,0; 1x 1/4"x23,0; 1x 9/32"x23,0; 1x 5/16"x23,0; 1x 3/8"x23,0; 1x 7/16"x23,0; 1x 1/2"x23,0; 1x 9/16"x23,0	
		8784 A1 1x 1/4"x1/4"x37,0	
		8794 SA 1x 1/4"x75,0	
		893/4/1 K 1x 1/4"x50	
		851/1 Z 1x PH 1x25; 1x PH 2x25	
		840/1 Z 1x 1/8"x25; 1x 5/32"x25; 1x 7/32"x25; 1x 1/4"x25	
		867/1 TORX® 1x TX 25x25	
		魔术贴 240 1x 50,0x240,0	

¹⁾ 不带Lasertip激光蚀刻刀头

Kraftform Kompakt H 1 木工作业

包含41种最常用的螺丝拧紧工具的紧凑型工具组套, 用于包括木制品的作业。

包括牢固的Zyklop Mini棘轮扳手, 带有延长杆、套筒和接头; 8个手动-动力工具套筒, 规格从5.5-13mm; 1个 816 RA手柄, 带棘轮功能、细齿设计使得小角度也可以扭转、切换装置(右-固定-左), 最大扭矩50Nm并且具有Rapidaptor的快速接头技术; 1个通用螺丝批手柄; 6个25mm长的批头; 16个89 mm长的批头; 5个麻花钻, 规格是3-8mm, 用于木制品作业; 1个螺钉钳子, 用于牢固地固定螺钉; 1个电压测试器247; 织物包十分坚固耐用; 可置于车间货架存放, 方便整洁; 纺织材质增加了外表面的保护作用; 轻便的设计便于携带。

- 坚固的Zyklop Mini棘轮扳手, 适用于批头接杆和套筒
- 细齿棘轮结构和小至6°的回转角, 使得扭矩大于65 Nm
- 应用了Rapidaptor技术的快速棘轮螺丝刀可快速更换批头
- 高品质木质材料用麻花钻, 用于在软木、硬木和薄钢板上钻孔
- 坚固的织物盒包装

Kraftform Kompakt H 1 木工作业

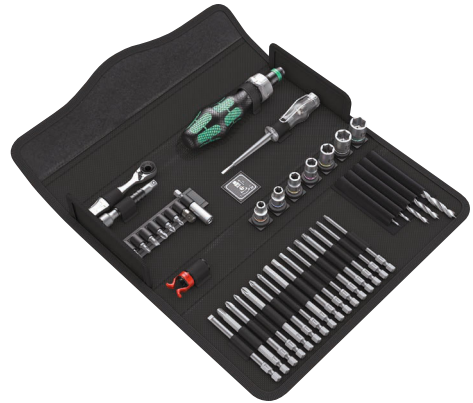

Code	EAN		
05135939001	4013288 178350		1
		● 816 RA 1x 1/4"x142,0	
		● 8001 A 1x 1/4"x87,0	
		○ 870/1 1x 1/4"x25 ¹⁾	
		● 8794 SA 1x 1/4"x75,0	
		● 8790 HMA 1x 5,5x23,0; 1x 6,0x23,0; 1x 7,0x23,0; 1x 8,0x23,0; 1x 10,0x23,0; 1x 12,0x23,0; 1x 13,0x23,0	
		● 893/4/1 K 1x 1/4"x50	
		⊕ 851/4 Z PH 1x PH 1x89; 1x PH 2x89; 1x PH 3x89 ²⁾	
		⊕ 855/4 Z PZ 1x PZ 1x89; 1x PZ 2x89; 1x PZ 3x89 ²⁾	
		⊕ 855/1 Z PZ 1x PZ 1x25; 1x PZ 2x25; 1x PZ 3x25	
		⊕ 867/4 Z TORX® BO 1x TX 10x89; 1x TX 15x89; 1x TX 20x89; 1x TX 25x89; 1x TX 30x89	
		⊕ 867/1 TORX® 1x TX 20x25; 1x TX 25x25	
		○ 840/4 Z Hex-Plus 1x 3,0x89; 1x 4,0x89; 1x 5,0x89; 1x 6,0x89 ²⁾	
		● 800/4 Z 1x 1,0x5,5x89	
		● 800/1 Z 1x 1,0x5,5x25	
		⊗ 849 HSS 1x 3,0x70,0; 1x 4,0x74,0; 1x 5,0x85,0; 1x 6,0x95,0; 1x 8,0x110,0	
		● 247 1x 0,5x3,0x70	
		1441 1x 4,5 - 6,0x41,0	

¹⁾ 带摩擦球, 用于手动螺母扳手套筒

²⁾ 六角形刀片

³⁾ 未在美国和加拿大上市

Kraftform Kompakt M 1 金属加工

紧凑型工具组套, 包含39种最常用的螺丝拧紧工具, 用于包括金属制品的作业。

包括 1/4" Zyklop Speed 快速棘轮扳手, 包含附件; 7个手动和动力工具套筒, 规格从5.5-13mm; 1个螺丝批头手柄; 13个89 mm长的批头; 6个组合丝锥批头; 6个用于金属作业的麻花钻, 规格从3-10mm; 1个螺钉钳子, 用于牢固地固定螺钉; 1个电压测试器247; 织物包十分坚固耐用; 可置于车间货架存放, 方便整洁; 纺织材质增加了外表面的保护作用; 轻便的设计便于携带。

Kraftform Kompakt M 1 金属加工



Code	EAN		
05135928001	4013288 178367		1
		8000 A 1x 1/4"x152,0	
		8794 LA 1x 1/4"x150,0	
		8794 A 1x 1/4"x56,0	
		8784 A1 1x 1/4"x1/4"x37,0	
		816 R 1x 1/4"x119	
		8790 HMA 1x 5,5x23,0; 1x 6,0x23,0; 1x 7,0x23,0; 1x 8,0x23,0; 1x 10,0x23,0; 1x 12,0x23,0; 1x 13,0x23,0	
		851/4 Z PH 1x PH 1x89; 1x PH 2x89; 1x PH 3x89 ¹⁾	
		840/4 Z Hex-Plus 1x 3,0x89; 1x 4,0x89; 1x 5,0x89; 1x 6,0x89 ¹⁾	
		867/4 Z TORX® 1x TX 10x89; 1x TX 15x89; 1x TX 20x89; 1x TX 25x89; 1x TX 30x89	
		800/4 Z 1x 1,0x5,5x89	
		847 HSS 1x 2,5x36,0; 1x 3,3x39,0; 1x 4,2x41,0; 1x 5,0x44,0; 1x 6,8x51,0; 1x 8,5x59,0	
		848 HSS 1x 3,0x38,0; 1x 4,0x44,0; 1x 5,0x50,0; 1x 6,0x50,0; 1x 8,0x51,0; 1x 10,0x54,0	
		1441 1x 4,5 - 6,0x41,0	
		247 1x 0,5x3,0x70	

¹⁾ 六角形刀片

²⁾ 未在美国和加拿大上市



Kraftform Kompakt SH 1 水暖安装

紧凑工具组, 含 25 个最重要的拧紧工具, 用于管道和暖气应用。含 2 个 JOKER 开口扳手、1/4" Zyklop 棘轮和配件、6 x 89 mm 批头、5 个 Kraftform 增强型 多重材料螺丝刀和测电笔。2 个 JOKER 组合式棘轮扳手, 含特殊固定板, 避免螺丝打滑/丢失, 传递更大扭矩; 1 个 Zyklop 棘轮 8000 A (1/4"), 快速有力作业; 3 个 Zyklop 套管 8790 HMA, 用于手工和电动工具应用; 1 个 Zyklop 转接头 8784 A1 用于批头; 6 个 TORX® HF 梅花螺丝批头 867/4, 含 TORX® 螺丝用固持功能, 稳固固持, 螺丝不丢失; 1 个测电笔 247; 2 个 Kraftform 系列 100 一字螺丝刀 160 i 和 160 iS 用于至多 1,000 伏特安全作业 (160 iS 轴径缩小, 一体式绝缘防护可触及并启动难以触及的螺丝和弹簧元件); 1 个 Kraftform 敲击螺丝刀 932 A (一字) 六角手柄一体式刀杆, 一体式冲击帽, 用于拧紧和简单敲凿作业; 2 个螺帽批头 395 H0, 含空心轴, 用于拧紧或拆卸长螺栓上的螺丝并松动卡死的螺丝。

“易寻”色标系统, 用特定颜色代表不同花形和尺寸, 以便快速查找所需工具。

- Joker两用棘轮扳手带特殊的挡块, 可防止螺丝的滑落和遗失
- Zyklop Speed棘轮扳手可快速而强力地工作
- Kraftform VDE绝缘一字螺丝刀, 可在1000V电压下安全作业
- Kraftform敲击螺丝刀, 带一体式冲击帽, 六角形刀杆贯穿整个手柄
- 中空套筒螺丝刀, 适合较长螺栓上的螺母拧紧

Kraftform Kompakt SH 1 水暖安装



Code	EAN		
	4013288		
05135927001	170132		1
		6000 Joker 1x 10x159; 1x 13x177	
		8000 A 1x 1/4"x152,0	
		8790 HMA 1x 7,0x23,0; 1x 10,0x23,0; 1x 13,0x23,0	
		8784 A1 1x 1/4"x1/4"x37,0	
		867/4 TORX® HF 2x TX 20x50; 2x TX 25x50; 1x TX 30x50; 1x TX 40x50 ¹⁾	
		851/4 Z PH 1x PH 1x89; 1x PH 2x89	
		840/4 Z Hex-Plus 1x 3,0x89; 1x 4,0x89; 1x 5,0x89; 1x 6,0x89 ²⁾	
		247 1x 0,5x3,0x70	
		160 iS 1x 0,6x3,5x100	
		160 i VDE 1x 1,0x5,5x125	
		932 A 1x 1,2x7,0x125	
		395 H0 1x 10,0x90; 1x 13,0x90	

¹⁾ 未在美国和加拿大上市

¹⁾ Pound-thru 六角: 无Take it easy易寻色标系统。

²⁾ 六角形刀片。

Kraftform Kompakt SH 2 水暖安装

- 适合水暖安装应用的15支 紧固工具，配有紧凑而坚固的Wera织布工具包。
- Joker两用棘轮扳手带特殊的挡块，可防止螺丝的滑落和遗失
- Kraftform VDE绝缘一字螺丝刀，可在1000V电压下安全作业
- Kraftform敲击螺丝刀，带一体式冲击帽，六角形刀杆贯穿整个手柄
- 中空套筒螺丝刀，适合较长螺栓上的螺母松紧
- Kraftform绝缘接杆和可更换式刀杆
- VDE 刀杆 (长 157 mm) 具有实用的旋转功能、防侧倾保护和“Take it easy”工具查找装置：带有侧面彩色编码和激光雕刻尺寸指示

Kraftform Kompakt SH 2 水暖安装



Code	EAN			
05136026001	204387			1
		●	395 H0 1x 10,0x90; 1x 13,0x90	
		●	932 A 1x 1,2x7,0x125	
			6001 Joker Switch 1x 10x159; 1x 13x179	
		○	950 SPKL HF Multicolour 1x 3,0x123; 1x 4,0x137; 1x 5,0x154; 1x 6,0x172	
		●	817 VDE 1x 9x98	
		+	Kraftform Kompakt VDE 62 iS Take it easy 1x PH 1x157; 1x PH 2x157	
		●	Kraftform Kompakt VDE 60 iS Take it easy 1x 0,6x3,5x157; 1x 1,0x5,5x157	
		●	247 1x 0,5x3,0x70	
			魔术贴 240 1x 50,0x240,0	

¹⁾ 未在美国和加拿大上市

Kraftform Kompakt F 1 窗户安装作业

紧凑型 维拉螺丝刀工具套装，包含 36 个窗户安装应用的重要工具

- 高级36件装通用工具套装，适合专业的窗户安装人员使用
- 393 S 超薄批头手动固持器，具有活动轴身，适合在难以到达的工作空间内使用
- 套筒扳手和各种规格的批头具有极高的Wera质量，并根据通用的窗户安装应用进行微调
- 设计紧凑且坚固耐用的帆布工具盒，兼容Wera 2go

Kraftform Kompakt F 1 窗户安装作业

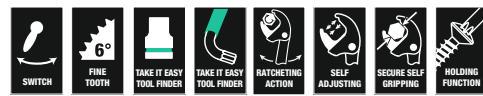

Code	EAN			
05134013001	217721			1
		●	393 S 1x 1/4"x173,5	
		●	813 1x 1/4"x78	
		○	8001 A 1x 1/4"x87,0	
		○	870/1 1x 1/4"x25 ¹⁾	
		○	8794 SA 1x 1/4"x75,0	
		●	8790 HMA 1x 7,0x23,0; 1x 8,0x23,0; 1x 10,0x23,0; 1x 13,0x23,0	
		+	851/4 TZ PH 1x PH 1x50; 1x PH 2x50; 1x PH 3x50	
		+	867/4 Z TORX® 1x TX 8x50; 1x TX 10x50; 1x TX 15x50; 1x TX 20x50; 1x TX 25x50; 1x TX 30x50	
		○	840/4 Z Hex-Plus 1x 2,0x50; 1x 2,5x50; 1x 3,0x50; 1x 4,0x50; 1x 5,0x50; 1x 6,0x89 ²⁾	
		○	950 SPKL Multicolour 1x 2,0x101; 1x 2,5x112	
		○	950 SPKL HF Multicolour 1x 3,0x123; 1x 4,0x137; 1x 5,0x154	
		+	967 SXL HF TORX® Multicolour 1x TX 8x90; 1x TX 10x112; 1x TX 15x123; 1x TX 20x137; 1x TX 25x154; 1x TX 30x195	
			6004 Joker S 1x 10-13 (7/16"-1/2")x154	

¹⁾ 带摩擦球，用于手动螺母扳手套筒

²⁾ 六角形刀片

车间用 9532 链条铆接机组套

适用于自行车车间的 18 件工具组套。使用 Zyklop Mini 批头棘轮和批头夹持螺丝刀以及长 89 mm 和 25 mm 的批头，可以操作内六角螺丝、TORX® 螺丝和十字螺丝。

通过随附的链条铆接机和带可更换铆钉销的链条紧固件，可以打开和关闭自行车链条（适用于单速链条，最高可达 12 速）。使用链条锁工具，让用链条锁打开和关闭链条变得更加容易。

- 自行车车间的工具组套
- 带 Wera Zyklop Mini 1 批头棘轮、816 R 批头夹持螺丝刀、一个链条铆接机、一个链条紧固件、配件组套链条铆接机销、一个链条锁工具、10 个 89 mm 长的批头、2 个 25 mm 长的批头
- 带有链条铆接机和链条紧固件，带有可更换的铆钉销，用于打开和关闭自行车链条。适用于单速链条，最高可达 12 速
- 快速释放自行车链条工具，用于用链条锁打开和关闭链条
- 坚固的帆布腰包装

车间用 9532 链条铆接机组套



Code	EAN		
05136042001	229571		1
		● 8001 A 1x 1/4"x87,0	
		● 816 R 1x 1/4"x119	
		⊕ 851/4 Z 1x PH 1x89; 1x PH 2x89	
		⊗ 867/4 Z TORX® 1x TX 10x89; 1x TX 25x89	
		○ 840/4 Z 1x 2,0x89; 1x 2,5x89; 1x 3,0x89; 1x 4,0x89; 1x 5,0x89; 1x 6,0x89 ¹⁾	
		○ 840/1 Z 1x 5,0x25; 1x 8,0x25	
		9512 Chain-Hook	
		9513 Chain 工具	
		9533 快速释放自行车链条工具 1x 167,5	
		9534 3x 15,0	

¹⁾六角形刀片

9100 吉他-工具套装

电吉他专用工具套装 该套装包含调整和维护电吉他所需的所有工具。Wera-Hex-Plus六角增强型不锈钢角度扳手（尺寸：1.5、2.0、2.5、5.0，英寸尺寸为 1/8"、5/32"、3/16"）。

适用于内六角螺钉的Wera 89 mm 不锈钢批头（尺寸：1.5、2.0、2.5），用于 1/4" 批头的Kraftform手柄，1/4" 插槽的不锈钢批头，用于一字螺丝（尺寸：1.8x 12x41 mm，0.6 x3.5x89 mm，1.2x8.0x89 mm），十字螺丝（尺寸：PH 1x89 mm，PH 2x89 mm）和内六角螺钉（尺寸：0.05"x25 mm），手柄用的Wera接头（1/4"方形驱动用的1/4"六角套筒），Wera Zyklop套筒（尺寸为10和1/2"），带 1/4"六角驱动的弦用曲柄，Knipex®切弦刀，厚薄规，插孔用顶压桩，2片拨片。

9100 吉他-工具套装

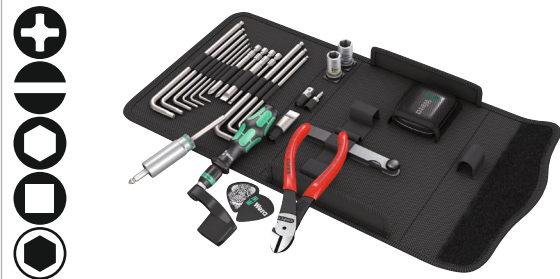

Code	EAN		
05134015001	211675		1
		● 815 R 1x 1/4"x119	
		⊕ 3851/4 1x PH 1x89; 1x PH 2x89	
		⊖ 3800/1 TS 1x 1,8x12,0x41	
		⊖ 3800/4 1x 0,6x3,5x89; 1x 1,2x8,0x89	
		○ 3840/1 TS 1x 0,05"x25	
		○ 3950 PKL 1x 1,5x90; 1x 2,0x101; 1x 2,5x112; 1x 3,0x123; 1x 4,0x137; 1x 5,0x154	
		○ 3950 PKL Imperial 1x 1/8"x123; 1x 5/32"x137; 1x 3/16"x154	
		○ 870/1 1x 1/4"x25 ¹⁾	
		● 8790 HMA 1x 10,0x23,0; 1x 7/16"x23,0	
		● 8790 HMA Deep 1x 1/2"x50,0	
		9103 卷线器	
		9105 量隙规 0,05 - 1,00mm · 13 叶片	
		9104 Jacker插口	
		9101 拨片 Wera	
		9102 拨片 Tool Rebel	
		9110 带盖的盒子 Wera	
		KNIPEX® 74 01 140	
		魔术贴 120 1x 50,0x120,0	

¹⁾带摩擦球，用于手动螺母扳手套筒

具有棘轮功能的838 RA-R M 批头夹持螺丝刀 · 1/4"

高级插换式螺丝刀。Kraftform Plus 手柄，符合人体工学设计的旋拧操作舒适，可避免出现起泡和老茧。

硬质手柄区域，适合较高的操作速度，软质手柄区域则适用于高扭矩传输。根据 DIN ISO 1173-C 6.3 标准，适合安装 1/4" 外六角驱动批头。

- 带 Rapidaptor 快速释放卡盘的批头夹持螺丝刀，适用于符合 DIN ISO 1173-C 6.3 和 E 6.3 要求的带 1/4" 外六角驱动批头，以及 Wera 连接系列 1 和 4
- 集成到手柄上的棘轮机构
- 细齿集成棘轮保证快速安全工作
- 高工作速度：棘轮机构也可用于在旋拧时“旋转”
- 符合人体工程学的直观切换到顺时针/逆时针或位置 0
- 快速接杆可快速更换批头
- 符合 ISO 1173-C 6.3和E 6.3标准的1/4" 外六角驱动批头
- Kraftform 多重材料手柄，符合人体工程学，可快速拆装螺丝
- 六角防滚动保护，防止螺丝刀的滚动
- 有磁性

具有棘轮功能的838 RA-R M 批头夹持螺丝刀 · 1/4"



Code	EAN	Hex	mm	mm				
05051493001	229748	1/4"	123,5	98				1

具有棘轮功能的 838 RA S 批头夹持螺丝刀 · 1/4"

高级插换式螺丝刀。Kraftform Plus 手柄，符合人体工学设计的旋拧操作舒适，可避免出现起泡和老茧。

硬质手柄区域，适合较高的操作速度，软质手柄区域则适用于高扭矩传输。根据 DIN ISO 1173-C 6.3 标准，适合安装 1/4" 外六角驱动批头。

- 用于 1/4" 外六角驱动批头的极小批头夹持螺丝刀
- 集成到手柄上的棘轮机构
- 细齿集成棘轮保证快速安全工作
- 高工作速度：棘轮机构也可用于在旋拧时“旋转”
- 符合人体工程学的直观切换到顺时针/逆时针或位置 0
- 批头支座中的强磁性永磁铁牢牢固定住批头
- 用于 1/4" 六角头驱动的批头夹具通用接杆
- Kraftform 多重材料手柄，符合人体工程学，可快速拆装螺丝
- 有磁性

具有棘轮功能的 838 RA S 批头夹持螺丝刀 · 1/4"



Code	EAN	Hex	mm	mm				
05051492001	229731	1/4"	102	84				1



Rapidaptor 快速批头接杆 – 令人惊艳的多功能工具



生锈问题的解决方案: 使用不锈钢工具拆装不锈钢螺丝。维拉不锈钢工具是由不锈钢材料制成, 可有效避免难看的锈蚀。

- 生锈问题的解决方案: 使用不锈钢工具拆装不锈钢螺丝
- 不锈钢快速批头接杆
- 安全夹持螺丝
- 快速更换批头
- 自由旋转护套, 可引导电动工具

Kraftform 不锈钢系列 – 避免生锈

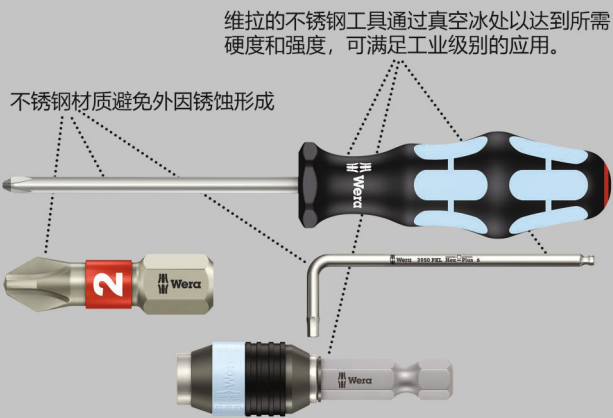

3816 R 不锈钢螺丝刀杆 · 带Rapidaptor快速接头



	EAN							
Code	4013288		mm					
05051465001	127570	1/4"	119					5

817 R 螺丝刀杆 · 带Rapidaptor快速接头

当独特的伸缩式刀杆缩回手柄内时, 即使是在极为狭小的区域内也可快速拆装螺丝。

按动卡扣, 伸缩式刀杆即可弹出, 使紧凑型螺丝刀扩展为全尺寸螺丝刀。

再次按动卡扣, 即可将刀杆取出, 直接用于接驳电动工具。可用于DIN ISO 1173-C 6,3和E 6,3标准的1/4"驱动批头, 以及维拉系列1和4的批头。

- 可伸缩式刀杆

817 R 螺丝刀杆 · 带Rapidaptor快速接头



	EAN							
Code	4013288		mm					
05051482001	103130	1/4"	133					2

817 R Kraftform手柄 · 吊卡装



	EAN							
Code	4013288							
05073541001	106025		817 R				1x 1/4"x133	1

816 R 螺丝刀杆 · 带Rapidaptor快速接头



Code	EAN	Hex	Length	Weight	Volume	Box
05051462001	4013288 099617	1/4"	119	mm		5

816 R 螺丝刀杆吊卡装



Code	EAN	Hex	Length	Weight	Volume	Box
05073540001	4013288 106032	816 R 1x 1/4"x119				1

813 R 螺丝刀杆 · 带Rapidaptor快速接头



Code	EAN	Hex	Length	Weight	Volume	Box
05051272001	4013288 103123	1/4"	90	mm		2

393 S 插换式软轴螺丝刀

插换式螺丝刀带可弯曲轴身, 适合狭小空间作业。采用薄身批头接杆, 即使在狭窄的空间, 也可轻松对应不同花形。符合人体工学的 Kraftform 复合材质手柄, 省力且便于快速拧转作业。六角防滚动设计, 减少置放时不必要的滚动。

- 活动、可弯折轴身
- 采用锁止机构, 具有安全的批头固定功能。带强磁性磁铁。
- 紧凑型不锈钢固定器, 适合具有1/4英寸外六角驱动头的批头, 依照 DIN 3126, ISO 1173 表 C 6.3
- Kraftform 多重材料手柄, 符合人体工程学, 可快速拆装螺丝

393 S 插换式软轴螺丝刀



Code	EAN	Hex	Length	Weight	Volume	Box
05028161001	4013288 217660	1/4"	173,5	98	6 53/64"	5

392 弹性杆组合螺丝刀柄

螺丝刀392也可在狭小区域拆装螺丝。其弹性刀杆可以触及苛刻位置的螺丝, 是汽车引擎相关工作难以进入区域作业的理想工具。

- 快速批头接杆, 带柔性杆
- 圆形柔性杆

392 弹性杆组合螺丝刀柄



Code	EAN	Hex	Length	Weight	Volume	Box
05028160001	4013288 041418	1/4"	177	98	7"	5

813 组合螺丝刀柄

- 批头接杆, 用于1/4"六角驱动的批头
- 有磁性

813 组合螺丝刀柄



	EAN	六角形刀杆	长度	长度			
Code	4013288		mm	mm			
05051274001	175656	1/4"	78	68			3

812/1 组合螺丝刀柄 · 带强磁性磁铁

- 六角形刀杆, 镀铬
- 不锈钢护套和强磁性磁铁, 可与批头精确配合

812/1 组合螺丝刀柄 · 带强磁性磁铁



	EAN	六角形刀杆	长度	长度	直径	长度	
Code	4013288		mm	mm	mm		
05051205001	012272	1/4"	120	112	10,5	4 3/4"	2

811/1 Stubby 迷你螺丝刀柄 · 磁性

带有短接杆的迷你批头手柄适宜于狭小作业空间。适用于符合 DIN ISO 1173-C 6.3标准的 1/4"六角驱动批头以及维拉系列1 双重材料手柄有硬质和软质区, 确保牢固握抓并精确作业。

强磁性磁将又大又重的螺丝也牢牢固持。双重材料手柄有硬质和软质区, 确保牢固握抓并精确作业。六角防滑设计减少了置放时滚动的风险。

- 小巧设计适合狭小空间内作业
- 符合人体工程学的双重材料 Kraftform 手柄提升作业精确度
- 六角防滑滚动保护, 防止螺丝刀的滚动
- 带磁性的批头手柄, 让螺丝安装过程更为轻松
- 符合DIN ISO 1173-C 6.3标准的1/4" 批头

811/1 Stubby 迷你螺丝刀柄 · 磁性



	EAN	六角形刀杆	长度	长度	长度		
Code	4013288		mm	mm			
05008880001	212375	1/4"	10	54	3/8"		2

810/1 组合螺丝刀柄 · 带卡环

- 批头接杆, 带卡环, 用于1/4"六角驱动的批头

810/1 组合螺丝刀柄 · 带卡环



	EAN	六角形刀杆	长度	长度	直径	长度	
Code	4013288		mm	mm	mm		
05051005001	012258	1/4"	120	112	10,5	4 3/4"	2

Kraftform Kompakt Vario. 带棘轮功能

棘轮手柄, 超小回转角, 环形换向开关 (右、锁定、左), 最大扭矩为50Nm; 1/4"六角, 带快速接头, 可以单手操作换装批头, 有磁性, 用于DIN ISO 1173-C 6.3和E 6.3标准的内六角批头, 以及维拉系列1和4的批头

- 应用了Rapidaptor技术的快速棘轮螺丝刀可快速更换批头
- 棘轮手柄的细齿棘轮具有小回转角
- 换向开关 (右、锁定、左)
- 最大扭矩可达50Nm
- Kraftform多重材料手柄, 符合人体工程学, 可快速拆装螺丝

816 RA 棘轮手柄



	EAN							
Code	4013288		mm					
05051461001	156280	1/4"	142,0					1

¹⁾ 停产。新版预定于2025年6月1日推出。

Kraftform Kompakt 60 RA 组套



	EAN							
Code	4013288							
05051040001	155290							1

	816 RA 1x 1/4"x142,0
	851/4 Z PH 1x PH 1x89; 1x PH 2x89; 1x PH 3x89 ¹⁾
	855/4 Z PZ 1x PZ 1x89; 1x PZ 2x89; 1x PZ 3x89 ¹⁾
	867/4 Z TORX® B0 1x TX 10x89; 1x TX 15x89; 1x TX 20x89; 1x TX 25x89; 1x TX 30x89
	800/4 Z 1x 1,0x5,5x89
	840/4 Z Hex-Plus 1x 3,0x89; 1x 4,0x89; 1x 5,0x89; 1x 6,0x89 ¹⁾

¹⁾ 六角形刀片

²⁾ 停产。新版预定于2025年6月1日推出。

Kraftform Kompakt 60 RA 组套 · 英制



	EAN							
Code	4013288							
05051041001	155306							1

	816 RA 1x 1/4"x142,0
	851/4 Z PH 1x PH 1x89; 1x PH 2x89; 1x PH 3x89 ¹⁾
	867/4 Z TORX® B0 1x TX 10x89; 1x TX 15x89; 1x TX 20x89; 1x TX 25x89; 1x TX 30x89
	800/4 Z 1x 1,0x5,5x89
	840/4 Z Hex-Plus 1x 3/32"x89; 1x 1/8"x89; 1x 5/32"x89; 1x 3/16"x89
	868/4 Square-Plus 1x # 1x89; 1x # 2x89; 1x # 3x89

¹⁾ 六角形刀片

²⁾ 停产。新版预定于2025年6月1日推出。

80 RA Vario 棘轮手柄

44齿细齿棘轮结构，极大地节省了拆装螺丝的作业时间。换向开关符合人体工程学。

另外，锁定的中间档可对作业进行精确调整，而不需要每次都改变作业方向。独特设计带有的快速接头的手柄能快速换装刀杆，足以应对多样化的应用。

- Vario棘轮螺丝刀，用于维拉6mm Vario刀杆
- 棘轮手柄的细齿棘轮具有小回转角
- 环形换向开关（右、锁定、左）
- 最大扭矩可达50Nm
- 光滑的硬质区可在手上快速滑动，软质抓握区可传递更大扭力

80 RA Vario 棘轮手柄



	EAN							
Code	4013288	mm	mm					
05002901001	156242	6	115,0					1

¹⁾ 停产。新版预定于2025年6月1日推出。

Kraftform Kompakt Vario RA SB 组套



Code	EAN		
05073665001	156266		1
		○ 80 RA 1x 6x115,0	
		⊕ 85 1x PH 1xPH 2x175	
		⊕ 86 1x PZ 1xPZ 2x175	
		⊕ 87 1x TX 10xTX 15x175; 1x TX 20xTX 25x175	
		⊕ 81 1x 0,6x4,0x1,0x6,0x175	
		○ 84 1x 4x5x175 ¹⁾	

¹⁾ 无球头

²⁾ 停产。新版预定于2025年6月1日推出。

Kraftform Kompakt RA · 枪形手柄

44齿细齿棘轮结构，极大地节省了拆装螺丝的作业时间。换向开关符合人体工程学。

另外，锁定的中间档可对作业进行精确调整，而不需要每次都改变作业方向。

- 细齿结构得到小至8°的回转角
- 只需使用环形换向开关
- Rapidaptor快速接头
- 带强磁性磁铁，可与批头精确配合
- Kraftform多重材料枪形手柄，优化杠杆效应

Kraftform Kompakt RA · 枪形手柄



Code	EAN		
05051030001	180360		1
		814 RA 1x 1/4"	
		⊕ 851/1 Z PH 1x PH 1x25; 1x PH 2x25	
		⊕ 855/1 Z PZ 1x PZ 1x25; 1x PZ 2x25	
		⊕ 867/1 TORX® 1x TX 20x25; 1x TX 25x25	

¹⁾ 停产。新版预定于2025年6月1日推出。

Kraftform Kompakt RA 4 · 枪形手柄



Code	EAN		
05051031001	187406		1
		814 RA 1x 1/4"	
		⊕ 851/1 BTZ PH 1x PH 1x25; 1x PH 2x25	
		⊕ 855/1 BTZ PZ 1x PZ 1x25; 1x PZ 2x25	
		⊕ 867/1 TORX® BTZ 1x TX 20x25; 1x TX 25x25	
		⊕ 851/4 Z PH 1x PH 1x89; 1x PH 2x89	
		⊕ 855/4 Z PZ 1x PZ 1x89; 1x PZ 2x89	
		⊕ 867/4 Z TORX® 1x TX 20x89; 1x TX 25x89	

¹⁾ 停产。新版预定于2025年6月1日推出。

Kraftform Kompakt 27 RA

44齿细齿棘轮结构, 极大地节省了拆装螺丝的作业时间。 换向开关符合人体工程学。

另外, 锁定的中间档可对作业进行精确调整, 而不需要每次都改变作业方向。

采用经过验证的夹具设计, 使工具完美匹配夹具, 特别坚固, 可用于持续作业。

- Kraftform Kompakt带棘轮功能, 高效作业
- Kraftform多重材料手柄, 带防滚动保护, 内置批头仓
- 细齿结构得到小回转角, 环形换向开关 (右、锁定、左)
- 最大扭矩可达50Nm
- 六角形刀杆, 1/4"六角接头, 不锈钢护套, 强磁性磁铁

Kraftform Kompakt 27 RA 1 SB

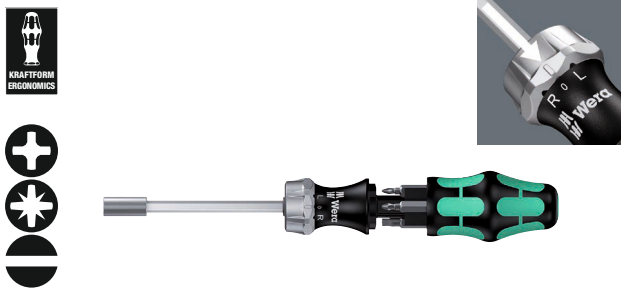

Code	EAN			
05073660001	4013288 156051			1
		+	851/1 Z PH 1x PH 1x25; 1x PH 2x25	
		+	855/1 Z PZ 1x PZ 1x25; 1x PZ 2x25	
		—	800/1 Z 1x 1,0x5,5x25; 1x 1,2x6,5x25	

¹ 停产。新版预定于2025年6月1日推出。

Kraftform Kompakt 27 RA 2 SB

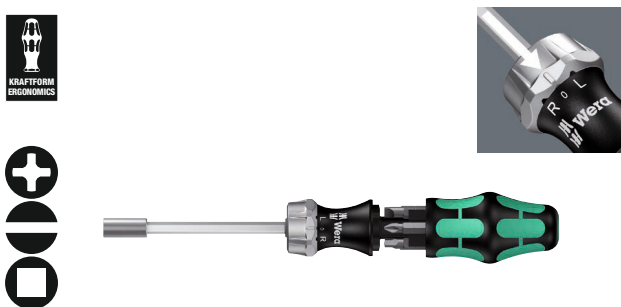

Code	EAN			
05073661002	4013288 156068			1
		+	851/1 Z PH 1x PH 1x25; 1x PH 2x25	
		—	800/1 Z 1x 1,0x5,5x25; 1x 1,2x6,5x25	
		□	868/1 Z 1x # 1x25; 1x # 2x25	

¹ 停产。新版预定于2025年6月1日推出。

88/1 Vario 组套

11件套, 特别适合要求苛刻的车间环境。 独特设计带有的快速接头的手柄能快速换装刀杆, 足以应对多样化的应用。

175mm长的6mm专用双头刀杆由优质钢材制成, 使用寿命极长。

Kraftform手柄的突出设计使手柄能完美地融入手中, 防止水泡和老茧等手部疲劳造成的损伤。

- Vario组套, 带手柄和10把两用刀杆
- 光滑的硬质区可在手上快速滑动, 软质抓握区可传递更大扭力
- 6mm六角形刀杆, 镀铬
- 黑色刀头, 可精确配合, 具有抗腐蚀性
- 坚固的腰包装

88/1 Vario 组套



Code	EAN			
05002990001	4013288 000675			1
		●	80 1x 6x98	
		+	85 1x PH 1xPH 2x175	
		+	86 1x PZ 1xPZ 2x175	
		+	87 1x TX 10xTX 15x175; 1x TX 20xTX 25x175; 1x TX 30xTX 40x175	
		—	81 1x 0,6x4,0x1,0x6,0x175; 1x 0,8x5,0x1,2x7,0x175	
		○	84 1x 4x4x175; 1x 5x5x175; 1x 6x6x175	

80 Vario 手柄

- Kraftform手柄, 带10mm六角加力螺栓
- 用于插入6mm Vario刀杆或Vario转接头

80 Vario 手柄



	EAN					
Code	4013288	mm	mm	mm		
05002900001	000460	6	10	98		5

95 Vario-刀杆专用 T型螺丝刀柄

T型柄螺丝刀柄:优化的手柄形状确保紧固和松开扭矩的传递。

手柄的人体工程学设计使手掌可以完全紧握它,手指可以支托在半圆形凹槽内。整个手部与手柄完全接触,不会产生摩擦损失。

符合DIN ISO 1173-C 6.3标准的1/4" 外六角驱动批头的手柄,带磁性,可轻松安装螺丝。

- T型柄螺丝刀, 确保紧固或松开时高扭力的传输。
- 符合人体工程学的双重材料手柄, 手指握柄和舒适的手感, 能最大程度传输扭力, 缓解作业疲劳。
- Vario T型柄手柄, 用于6mm的Vario刀杆和转接头

95 Vario-刀杆专用 T型螺丝刀柄



	EAN						
Code	4013288	mm	mm	mm	mm		
05023400001	208446	6	60	44	100	2 23/64"	2

830 Vario 批头用转接头

- Vario转接头刀杆, 带快速接头, 可用于Vario夹具
- 用于1/4"六角头驱动的批头夹具
- 1/4"快速接头, 带强磁性磁铁

830 Vario 批头用转接头



	EAN						
Code	4013288	mm	mm	mm			
05051835001	012425	1/4"	6	165	6 9/16"		2

91 Vario 延长杆

- Vario延长杆, 用于Vario刀杆和转接头
- 6mm六角形, 镀铬

91 Vario 延长杆



	EAN						
Code	4013288	mm	mm	mm			
05003210001	000804	6	6	175	7"		2

712 Vario 套筒转接头

- 用于套筒

712 Vario 套筒转接头



	EAN						
Code	4013288		mm	mm			
05040001001	006165	1/4"	6	175	7"		2

Vario 双头刀杆

175mm长的6mm专用双头刀杆由优质钢材制成，使用寿命极长。

81 Vario 双头刀杆 · 一字螺丝



	EAN	┌	└	┌	└	⬡	┌	└	📦
Code	4013288	mm	mm	mm	mm	mm	mm	mm	
05002910001	000477	0,6	4,0	1,0	6,0	6	175	7"	5
05002913001	000484	0,8	5,0	1,2	7,0	6	175	7"	5

82 Vario 双头刀杆 · 一字/十字螺丝



	EAN	+	┌	└	⬡	┌	└	📦
Code	4013288		mm	mm	mm	mm		
05002920001	000491	PH 1	0,6	4,0	6	175	7"	5
05002923001	000507	PH 2	1,0	6,0	6	175	7"	5
05002926001	000514	PH 3	1,2	7,0	6	175	7"	5

83 Vario 双头刀杆 · 十字/米字螺丝



	EAN	+	✳	⬡	┌	└	📦
Code	4013288			mm	mm		
05002930001	000521	PH 1	PZ 1	6	175	7"	5
05002933001	000538	PH 2	PZ 2	6	175	7"	5

84 Vario 双头刀杆 · 内六角螺丝



	EAN	⬡	⬡	⬡	┌	└	📦
Code	4013288			mm	mm		
05002936001	000545	2,5	2,5	6	175	7"	5
05002938001	000552	3	3	6	175	7"	5
05002940001	000569	4	4	6	175	7"	5
05002943001	000576	5	5	6	175	7"	5
05002948001 ¹⁾	155436	4	5	6	175	7"	5
05002946001	000583	6	6	6	175	7"	5

¹⁾无球头

85 Vario 双头刀杆 · 十字螺丝



	EAN	+	+	⬡	┌	└	📦
Code	4013288			mm	mm		
05002950001	000590	PH 1	PH 2	6	175	7"	5

86 Vario 双头刀杆 · 米字螺丝



	EAN	✳	✳	⬡	┌	└	📦
Code	4013288			mm	mm		
05002960001	000606	PZ 1	PZ 2	6	175	7"	5
05140310001	000613	PZ 2	PZ 3	6	175	7"	5

87 Vario 双头刀杆 · TORX®梅花螺丝



	EAN	✳	✳	⬡	┌	└	📦
Code	4013288			mm	mm		
05002966001	000620	TX 6	TX 8	6	175	7"	5
05002968001	000637	TX 7	TX 9	6	175	7"	5
05002970001	000644	TX 10	TX 15	6	175	7"	5
05002973001	000651	TX 20	TX 25	6	175	7"	5
05002976001	000668	TX 30	TX 40	6	175	7"	5

68 Vario 双头刀杆 · 内四方螺丝



	EAN	□	□	⬡	┌	└	📦
Code	4013288			mm	mm		
05002980001	100061	#1	#2	6	175	7"	5



车间手推车和泡沫 棉内装插盘



9700 Tool Rebel 车间手推车 1

Tool Rebel 设计中的专用车间手推车。五个扁平抽屉和两个高抽屉确保工具和材料的高效移动设计。

由于双壁构造和全焊结构，设计极为坚固。适用于车间日常高强度工作。

配备四块 Wera 泡垫：9710 泡垫螺丝刀组套 1，9720 泡垫 8000 A Zyklop 棘轮组套 1，9731 泡垫 6003 Joker 环形扳手套套 1，9740 泡垫 L 型扳手套套 1。

- Tool Rebel 设计中的专用车间手推车
- 由于双面设计，设计极为坚固
- 有 7 个抽屉 (5 个平, 2 个高)，其中 2 个扁平抽屉配备有泡垫和工具 (例如, Zyklop Speed 棘轮和配件、Joker 扳手、Kraftform 螺丝刀、L 型扳手)
- 扁平抽屉尺寸 (宽x高x深) : 522 x 81 x 398 mm
- 高抽屉尺寸 (宽x高x深) : 522 x 166 x 398 mm
- 100% 抽屉用滚珠轴承伸缩滑块抽出，自动关闭
- 所有抽屉均经过精心设计，层搭独一无二
- 由于抽屉止位块，倾斜的风险极小——只能打开一个抽屉，不能同时抽出多个抽屉
- 方头钻孔两侧
- 高品质、耐用的泡沫嵌件，不使用化学气体
- 贴合度优化，可从泡垫中以最佳方式移除工具

9700 Tool Rebel 车间手推车 1



Code	EAN		
05150130001	4013288 225085		1
1x 9710 泡垫螺丝刀组套 1			
		932 A 1x 1.0x5.5x100; 1x 1.2x7.0x125	
		350 1x PH 1x80; 1x PH 2x100; 1x PH 3x150	
		350 PH Stubby 1x PH 2x25	
		355 1x PZ 1x80; 1x PZ 2x100	
		335 1x 0.8x4.0x100; 1x 1.0x5.5x125	
		334 1x 1.2x6.5x150	
		335 Stubby/迷你螺丝刀 1x 1.0x5.5x24.5	
		2050 Micro 1x PH 0x40 ¹⁾	
		2035 Micro 1x 0.40x2.5x80	
		160 i VDE 1x 0.4x2.5x80 ²⁾ ; 1x 0.6x3.5x100 ²⁾	
		1441 1x 4.5-6.0x41.0	
		1442 1x 6,0-8,5x41.0	
		9810 1x 344,0x30,0x392,0 ³⁾	

1x 9720 泡垫 8000 A Zyklop 1/4" 棘轮组套 1	
○	8000 A 1x 1/4"x152.0
●○	8794 LA 1x 1/4"x150.0
●○	8794 SA 1x 1/4"x75.0
●○	8795 A 1x 1/4"x35.5
●○	8794 A 1x 1/4"x56.0
●	8790 HMA 1x 4.0x23.0; 1x 4.5x23.0; 1x 5.0x23.0; 1x 5.5x23.0; 1x 6.0x23.0; 1x 7.0x23.0; 1x 8.0x23.0; 1x 9.0x23.0; 1x 10.0x23.0; 1x 11.0x23.0; 1x 12.0x23.0; 1x 13.0x23.0; 1x 14.0x23.0; 1x 15.0x23.0
⊕	8767 A HF 1x TX 8x28,0; 1x TX 9x28,0; 1x TX 10x28,0; 1x TX 15x28,0; 1x TX 20x28,0; 1x TX 25x28,0; 1x TX 27x28,0; 1x TX 30x28,0; 1x TX 40x28,0
○	8740 A HF 1x 3.0x28,0; 1x 4.0x28,0; 1x 4.0x100,0; 1x 5.0x28,0; 1x 5.0x100,0; 1x 6.0x28,0; 1x 6.0x100,0; 1x 8.0x28,0; 1x 8.0x100,0
	9820 1x 172,0x30,0x392,0 ³⁾
1x 9720 泡垫 8000 A Zyklop 1/4" 棘轮组套 1	
	6003 Joker 1x 6x105; 1x 7x110; 1x 8x115; 1x 9x120; 1x 10x125; 1x 11x135; 1x 12x148; 1x 13x160; 1x 14x167; 1x 15x174; 1x 16x182; 1x 17x190; 1x 18x210; 1x 19x230; 1x 20x230; 1x 21x260; 1x 22x260; 1x 24x280
	开瓶器 1x 145
	9831 1x 344,0x30,0x392,0 ³⁾
1x 9740 泡垫 L 型扳手组套 1	
1x 950/9 Hex-Plus Multicolour 1	
○	950 SPKL Multicolour 1x 1.5x90; 1x 2.0x101; 1x 2.5x112; 1x 3.0x123; 1x 4.0x137; 1x 5.0x154; 1x 6.0x172; 1x 8.0x195; 1x 10.0x224
1x 967/9 TX XL Multicolour 1	
⊕	967 SXL TORX® Multicolour 1x TX 8x90; 1x TX 9x101; 1x TX 10x112
⊕	967 SPKXL TORX® Multicolour 1x TX 15x123; 1x TX 20x137; 1x TX 25x154; 1x TX 27x172; 1x TX 30x195; 1x TX 40x224
	1x 9500 充/消磁装置 SB 1x 64,6
	1x STABILA® 袖珍卷尺 BM 100 · 3 m · 项目 19570
	1x 9840 1x 172,0x30,0x392,0 ³⁾

¹⁾ 尺寸0根据JCS 0 (日本相机工业标准) 修改

²⁾ 不带Lasertip激光蚀刻刀头

³⁾ 注意: 泡垫不适用于旧型号 05501051001 的车间手推车

9710 泡垫螺丝刀组套 1

耐用泡垫; 双色快速识别缺失部件; 适用于 Tool Rebel 车间手推车, 配备 16 个 Wera Kraftform 螺丝刀 (车间、VDE、凿刀、Micro) 和 2 个螺丝夹具。

- 耐用泡垫, 每种工具都有自己的位置; 工具会很快被发现
- 高品质、耐用的泡沫插件, 不使用化学气体
- 贴合度优化, 可从泡垫中以最佳方式移除工具
- 防水拒油, 维护成本低, 易于清洁
- 保护工具免受污垢和冲击
- 8 Kraftform Plus 螺丝刀, 硬质区确保高效作业, 软质区确保高扭矩传输
- 2 件带绝缘刀杆的 Kraftform Plus VDE 螺丝刀, 用于安全工作, 工作电压不超过 1,000 伏
- 2 个带旋转盖的 Kraftform 微型螺丝刀, 用于快速旋转
- 2 个带短刀杆的插换式螺丝刀, 用于难以到达的区域
- 两个螺丝夹持器 (工具配件, 带螺丝固持功能)
- 宽x高x深: 无工具344 x 30 x 392 mm、有工具 344 x 47 x 392 mm

9710 泡垫螺丝刀组套 1

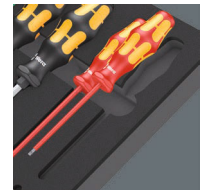

Code	EAN		
05150101001	4013288 225122		1
		●	932 A 1x 1,0x5,5x100; 1x 1,2x7,0x125
		⊕	350 1x PH 1x80; 1x PH 2x100; 1x PH 3x150
		⊕	350 PH Stubby 1x PH 2x25
		⊕	355 1x PZ 1x80; 1x PZ 2x100
		●	335 1x 0,8x4,0x100; 1x 1,0x5,5x125
		●	334 1x 1,2x6,5x150
		●	335 Stubby/迷你螺丝刀 1x 1,0x5,5x24,5
		⊕	2050 Micro 1x PH 0x40 ¹⁾
		●	2035 Micro 1x 0,40x2,5x80
		●	160 i VDE 1x 0,4x2,5x80 ²⁾ ; 1x 0,6x3,5x100 ²⁾
			1441 1x 4,5-6,0x41,0
			1442 1x 6,0-8,5x41,0
			9810 1x 344,0x30,0x392,0 ³⁾

¹⁾ 尺寸0根据JCS 0 (日本相机工业标准) 修改

²⁾ 不带Lasertip激光蚀刻刀头

³⁾ 注意: 泡垫不适用于旧型号 05501051001 的车间手推车

9711 泡垫 VDE 螺丝刀组套 1

- 带绝缘刀杆的螺丝刀安全工作, 工作电压不超过1,000伏, 其中 5 个刀杆直径缩小, 适用于沉头螺丝
- 两个螺丝夹持器 (工具配件, 带螺丝固持功能)
- 宽x高x深: 无工具344 x 30 x 392 mm、有工具 344 x 46 x 392 mm

9711 泡垫 VDE 螺丝刀组套 1

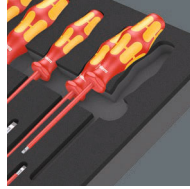

Code	EAN			
05150102001	4013288 225320			1
		+	162 iS PH VDE 1x PH 1x80; 1x PH 2x100	
		+	165 iS PZ VDE 1x PZ 1x80; 1x PZ 2x100	
		+	165 i PZ/S VDE 1x # 2x100	
		-	160 i VDE 1x 0,4x2,5x80 ¹⁾ ; 1x 0,8x4,0x100; 1x 1,0x5,5x125	
		-	160 iS VDE 1x 0,6x3,5x100	
		*	167 i TORX® VDE 1x TX 10x80; 1x TX 15x80; 1x TX 20x80; 1x TX 25x100; 1x TX 30x100	
			1440 1x 4,5-6,0x41,0	
			1442 1x 6,0-8,5x41,0	
			9811 1x 344,0x30,0x392,0 ²⁾	

¹⁾ 不带Lasertip激光蚀刻刀头

²⁾ 注意: 泡垫不适用于旧型号 05501051001 的车间手推车。

9712 泡垫 TORX® HF 螺丝刀组套 1

- 6 Kraftform Plus 螺丝刀, 硬质区确保高效作业, 软质区确保高扭矩传输
- 4 个带旋转盖的 Kraftform 微型螺丝刀, 用于快速旋转
- 4 个 T 型柄螺丝刀允许传递极高的拧紧和松开扭矩
- 宽x高x深: 无工具344 x 30 x 392 mm、有工具 344 x 45 x 392 mm

9712 泡垫 TORX® HF 螺丝刀组套 1



Code	EAN			
05150103001	4013288 225283			1
		*	367 TORX® HF 1x TX 8x60; 1x TX 9x60; 1x TX 10x80; 1x TX 15x80; 1x TX 20x100; 1x TX 25x100	
		*	2067 TORX® HF Micro 1x TX 4x40; 1x TX 5x40; 1x TX 6x40; 1x TX 7x60	
		*	467 TORX® HF 1x TX 20x100; 1x TX 25x100; 1x TX 30x200; 1x TX 40x200	
			9812 1x 344,0x30,0x392,0 ¹⁾	

¹⁾ 注意: 泡垫不适用于旧型号 05501051001 的车间手推车。

9713 泡垫六角螺丝刀组套 1

- 4 个 Kraftform Plus 螺丝刀, 硬质区确保高效作业, 软质区确保高扭矩传输, 其中 2 个带凸出螺纹杆空心轴
- 3 个带旋转盖的 Kraftform 微型螺丝刀, 用于快速旋转
- 5 个 T 型柄螺丝刀, 用于传输特别高的紧固和松动扭矩, 带有内六角螺丝的固定功能
- 内六角外形 (防止内六角螺丝转动圆柱)
- 宽x高x深: 无工具344 x 30 x 392 mm、有工具 344 x 45 x 392 mm

9713 泡垫六角螺丝刀组套 1

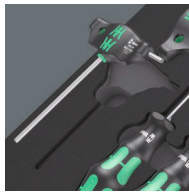
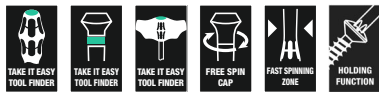

Code	EAN		
05150104001	225290		1
		○ 354 1x 3,0x75; 1x 4,0x75	
		○ 2054 Micro 1x 1,5x60; 1x 2x60; 1x 2,5x60	
		○ 454 HF 1x 4x100; 1x 5x100; 1x 6x150; 1x 8x200; 1x 10x200	
		● 395 H0 1x 10,0x90; 1x 13,0x90	
		9813 1x 344,0x30,0x392,0 ¹⁾	

¹⁾ 注意: 泡垫不适用于旧型号 05501051001 的车间手推车。

9714 泡垫、敲凿用螺丝刀组套 1

- 13 个用于旋拧、凿切和榫接的凿子
- 六角形刀杆贯穿整个手柄
- 冲击帽和加力螺栓传输更大扭力
- 宽x高x深: 无工具344 x 30 x 392 mm、有工具 344 x 46 x 392 mm

9714 泡垫、敲凿用螺丝刀组套 1

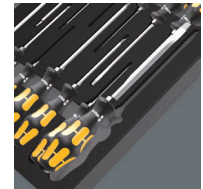

Code	EAN		
05150105001	232540		1
		⊕ 917 SPH 1x PH 1x80; 1x PH 2x100; 1x PH 3x150	
		⊕ 918 SPZ 1x PZ 1x80; 1x PZ 2x100; 1x PZ 3x150	
		⊖ 932 A 1x 0,6x3,5x80 ¹⁾ ; 1x 0,8x4,5x90; 1x 1,0x5,5x100; 1x 1,2x7,0x125; 1x 1,6x9,0x150	
		⊗ 977 TORX® 1x TX 20x90; 1x TX 25x100	
		9814 1x 344,0x30,0x392,0	

¹⁾ 圆形刀杆, 不带冲击帽和六角螺栓

²⁾ 注意: 泡垫不适用于旧型号 05501051001 的车间手推车。



9715 泡垫 Kraftform 微型螺丝刀组套 1

- Kraftform Micro 螺丝刀
- Kraftform多重材料精密手柄，符合人体工程学，可快速拆装螺丝
- 带防滚动保护和旋转帽用于快速旋转
- 维拉黑色刀头，可精确配合，具有最佳的抗腐蚀性
- “易寻”色标系统：用特定的颜色代表不同端头种类和尺寸
- 宽x高x深：无工具 344 x 30 x 392 mm、有工具 344 x 38 x 392 mm

9715 泡垫 Kraftform 微型螺丝刀组套 1

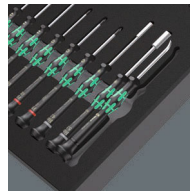

Code	EAN		
05150106001	4013288 232557		1
		⊕ 2050 Micro 1x PH 000x40 ¹⁾ 2); 1x PH 00x40 ¹⁾ 2); 1x PH 0x40 ³⁾	
		⊕ 2067 TORX® HF 1x TX 5x40; 1x TX 6x40; 1x TX 7x60; 1x TX 8x60; 1x TX 10x60	
		⊕ 2067 TORX PLUS® IPR Micro 1x 1 IPRx40 ⁴⁾	
		⊕ 2072 Micro 1x mx40	
		○ 2054 Micro 1x 0,7x40; 1x 0,9x40; 1x 1,3x40; 1x 1,5x60; 1x 2x60	
		⊖ 2035 Micro 1x 0,23x1,5x40; 1x 0,30x1,8x60; 1x 0,35x2,5x40; 1x 0,40x2,0x60; 1x 0,40x2,5x80; 1x 0,50x3,0x80	
		● 2069 Micro 1x 4,0x60; 1x 5,5x60	
		● 1429 1x 1,0x3,5x50	
		9815 1x 344,0x30,0x392,0	

¹⁾ 专为亚洲的十字PH螺丝优化

²⁾ 刀头的标称长度为10 mm

³⁾ 尺寸Ø根据JICIS 0 (日本相机工业标准) 修改

⁴⁾ 无球头

⁷⁾ 注意：泡垫不适用于旧型号 05501051001 的车间手推车。

9720 泡垫 8000 A Zyklop 1/4" 棘轮组套 1

- Zyklop Speed 棘轮将五种棘轮类型组合在一起
- 具有飞轮设计和极高工作速度的防滑快速旋转套筒
- 可自由转动的棘轮头，按钮释放，可拨杆左右换向
- 细齿结构得到小至5°的回转角
- 也可用作螺丝刀
- 组套包括套筒、批头套筒、扩展套筒和通用接头
- 14个套筒，9个带 TORX® 梅花螺丝固持功能的批头套筒，9个带有六角螺丝固持功能的批头套筒
- 宽x高x深：无工具 172 x 30 x 392 mm、有工具 172 x 40 x 392 mm

9720 泡垫 8000 A Zyklop 1/4" 棘轮组套 1



Code	EAN		
05150110001	4013288 225139		1
		□ 8000 A 1x 1/4"x152,0	
		■ 8794 LA 1x 1/4"x150,0	
		■ 8794 SA 1x 1/4"x75,0	
		■ 8795 A 1x 1/4"x35,5	
		■ 8794 A 1x 1/4"x56,0	
		● 8790 HMA 1x 4,0x23,0; 1x 4,5x23,0; 1x 5,0x23,0; 1x 5,5x23,0; 1x 6,0x23,0; 1x 7,0x23,0; 1x 8,0x23,0; 1x 9,0x23,0; 1x 10,0x23,0; 1x 11,0x23,0; 1x 12,0x23,0; 1x 13,0x23,0; 1x 14,0x23,0; 1x 15,0x23,0	
		⊕ 8767 A HF 1x TX 8x28,0; 1x TX 9x28,0; 1x TX 10x28,0; 1x TX 15x28,0; 1x TX 20x28,0; 1x TX 25x28,0; 1x TX 27x28,0; 1x TX 30x28,0; 1x TX 40x28,0	
		○ 8740 A HF 1x 3,0x28,0; 1x 4,0x28,0; 1x 4,0x100,0; 1x 5,0x28,0; 1x 5,0x100,0; 1x 6,0x28,0; 1x 6,0x100,0; 1x 8,0x28,0; 1x 8,0x100,0	
		9820 1x 172,0x30,0x392,0 ¹⁾	

¹⁾ 注意：泡垫不适用于旧型号 05501051001 的车间手推车。

9721 泡垫 8000 B Zyklop 3/8" 棘轮组套 1

- Zyklop Speed 棘轮将五种棘轮类型组合在一起
- 具有飞轮设计和极高工作速度的防滑快速旋转套筒
- 可自由转动的棘轮头, 按钮释放, 可拨杆左右换向
- 细齿结构得到小至5°的回转角
- 也可用作螺丝刀
- 组套包括套筒、扩展套筒和通用接头
- 宽x高x深: 无工具172 x 30 x 392 mm、有工具172 x 45 x 392 mm

9721 泡垫 8000 B Zyklop 3/8" 棘轮组套 1



Code	EAN		
05150111001	4013288 225306		1
		8000 B 1x 3/8"x199,0	
		8794 SB 1x 3/8"x125,0	
		8794 LB 1x 3/8"x200,0	
		8795 B 1x 3/8"x50,0	
		8794 B 1x 3/8"x76,0	
		8790 HMB 1x 6,0x29,0; 1x 7,0x29,0; 1x 8,0x29,0; 1x 9,0x29,0; 1x 10,0x29,0; 1x 11,0x29,0; 1x 12,0x29,0; 1x 13,0x29,0; 1x 14,0x29,0; 1x 15,0x29,0; 1x 16,0x30,0; 1x 17,0x30,0; 1x 18,0x30,0; 1x 19,0x30,0; 1x 20,0x30,0; 1x 21,0x30,0; 1x 22,0x30,0; 1x 24,0x32,0	
		9821 1x 172,0x30,0x392,0 ¹⁾	

¹⁾ 注意: 泡垫不适用于旧型号 05501051001 的车间手推车。

9722 泡垫 8000 C Zyklop 1/2" 棘轮组套 1

- Zyklop Speed 棘轮将五种棘轮类型组合在一起
- 可自由转动的棘轮头, 按钮释放, 可拨杆左右换向
- 细齿结构得到小至5°的回转角
- 组套包括套筒、扩展套筒和通用接头
- 17 个套筒, 9 个带有六角驱动螺丝固持功能的批头套筒
- 宽x高x深: 无工具344 x 30 x 392 mm、有工具344 x 51 x 392 mm

9722 泡垫 8000 C Zyklop 1/2" 棘轮组套 1



Code	EAN		
05150112001	4013288 225207		1
		8000 C 1x 1/2"x277,0	
		8794 LC 1x 1/2"x250,0	
		8794 SC 1x 1/2"x125,0	
		8795 C 1x 1/2"x69,0	
		8794 C 1x 1/2"x52,0	
		8790 HMC 1x 10,0x37,0; 1x 11,0x37,0; 1x 12,0x37,0; 1x 13,0x37,0; 1x 14,0x37,0; 1x 15,0x37,0; 1x 16,0x37,0; 1x 17,0x37,0; 1x 18,0x37,0; 1x 19,0x37,0; 1x 20,0x37,0; 1x 21,0x37,0; 1x 22,0x37,0; 1x 24,0x37,0; 1x 27,0x40,0; 1x 30,0x42,0; 1x 32,0x42,0	
		8740 C HF 1x 4,0x60,0; 1x 4,0x140,0; 1x 5,0x60,0; 1x 5,0x140,0; 1x 6,0x60,0; 1x 6,0x140,0; 1x 7,0x60,0; 1x 8,0x60,0; 1x 10,0x60,0	
		9822 1x 344,0x30,0x392,0 ¹⁾	

¹⁾ 注意: 泡垫不适用于旧型号 05501051001 的车间手推车。



9723 泡垫 Zyklop B 3/8" 批头套筒组套 1

- 旋具套筒 (非冲击), 用于手动和电动工具
- 10 个带 TORX® 梅花螺丝固持功能的批头套筒, 11 个带有六角形套筒螺丝固持功能的批头套筒, 1 个带有快速释放夹持的 Zyklop 插件, 用于 1/4" 批头
- 带 „易寻“ 色标系统, 可轻松找到所需套筒
- 尾部滚花以便于手指握持操作
- 铬钒, 加强硬度和强度
- 宽x高x深: 无工具172 x 30 x 392 mm、有工具 172 x 39 x 392 mm

9723 泡垫 Zyklop B 3/8" 批头套筒组套 1



Code	EAN		
05150113001	4013288 225313		1
		8784 B1 1x 1/4"x3/8"x44,0	
		8767 B HF 1x TX 15x35,0; 1x TX 20x35,0; 1x TX 25x35,0; 1x TX 25x107,0; 1x TX 27x35,0; 1x TX 27x107,0; 1x TX 30x35,0; 1x TX 30x107,0; 1x TX 40x35,0; 1x TX 40x107,0	
		8740 B HF 1x 4,0x35,0; 1x 4,0x107,0; 1x 5,0x35,0; 1x 5,0x107,0; 1x 6,0x35,0; 1x 6,0x107,0; 1x 7,0x38,5; 1x 8,0x38,5; 1x 8,0x100,0; 1x 10,0x38,5; 1x 10,0x100,0	
		9823 1x 172,0x30,0x392,0 ¹⁾	

¹⁾ 注意: 泡垫不适用于旧型号 05501051001 的车间手推车。

9724 泡垫 8010 B Zyklop 3/8" 舒适型棘轮组套 1

- 1 个 Zyklop 舒适型棘轮, 14 个 8790 B Impaktor 套筒, 1 个 8798 B Zyklop 延长杆; 3/8"
- Zyklop 舒适型棘轮, 带塑料套筒, 触感舒适
- 热塑镀膜表面防护
- 80 细齿, 小至 4.5° 的回转角
- 超薄型设计, 手柄柔软, 带人体工学设计, 方便在狭小空间作业
- 通过按钮安全锁住套筒, 换向拨杆, 方便换向
- 8790 B Impaktor 套筒, 同样适合与电动或气动扳手搭配使用, 3/8"
- 采用 Impaktor 技术的套筒, 其使用寿命高于平均水平
- 配 Take it easy 易寻色标系统的套筒: 用特定颜色代表不同尺寸与花型
- 宽x高x深: 无工具172 x 30 x 392 mm、有工具 172 x 48 x 392 mm

9724 泡垫 8010 B Zyklop 3/8" 舒适型棘轮组套 1

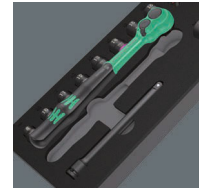

Code	EAN		
05150114001	4013288 232564		1
		8010 B 1x 3/8"x230,0	
		8790 B Impaktor 1x 8,0x30,0; 1x 10,0x30,0; 1x 11,0x30,0; 1x 12,0x30,0; 1x 13,0x30,0; 1x 14,0x30,0; 1x 15,0x30,0; 1x 16,0x30,0; 1x 17,0x30,0; 1x 18,0x30,0; 1x 19,0x30,0; 1x 21,0x32,0; 1x 22,0x32,0; 1x 24,0x32,0	
		8798 B 1x 3/8"x152,4	
		9824 1x 172,0x30,0x392,0	

¹⁾ 注意: 泡垫不适用于旧型号 05501051001 的车间手推车。

9725 泡垫 Zyklop C · 1/2" · Impaktor Deep 套筒组套 1

- 经久耐用的 Impaktor冲击套筒扳手嵌件可在极高应力条件下使用, 适合采用电动或气动扳手的应用, 12.5 mm = 1/2" 驱动
- 长型套筒扳手可用于难以触及的接头, 适合在密闭空间内装配长螺杆
- 六角端头可传递较高扭矩, 同时确保精密作业, 有利于端头拧紧
- 带十字孔和环状扣环, 可固定套筒的固定销和O环
- 宽x高x深: 无工具172 x 30 x 392 mm、有工具172 x 48 x 392 mm

9725 泡垫 Zyklop C · 1/2" · Impaktor Deep 套筒组套 1



Code	EAN		
05150115001	4013288 232571		1
		8790 C Impaktor Deep 1x 13,0x83,0; 1x 14,0x83,0; 1x 15,0x83,0; 1x 16,0x83,0; 1x 17,0x83,0; 1x 18,0x83,0; 1x 19,0x83,0; 1x 21,0x83,0; 1x 22,0x83,0; 1x 24,0x83,0; 1x 27,0x83,0	
		9825 1x 172,0x30,0x392,0	

*) 注意: 泡垫不适用于旧型号 05501051001 的车间手推车。

9726 泡垫 8007 B VDE Zyklop 3/8" VDE 棘轮组套 1

- 经绝缘处理并且经过 100% 单独测试的 Zyklop 8007 B 棘轮, 最高可在1000V电压下安全操作
- 80 齿细齿棘轮, 回转角仅 4.5°
- 超薄型设计, 手柄柔软, 带人体工程学设计, 方便在狭小空间作业
- 热塑镀膜表面防护
- 套筒、批头套筒和延长杆, 由于采用双重材料绝缘层并且黄色绝缘芯置于外部红色绝缘层下方, 因此安全性更高
- 带夹持功能的 8767 B VDE HF 批头套筒, 适用于符合 Acument Intellectual Properties 规格的 TORX® 螺丝
- 8740 B VDE HF 批头套筒, 带夹持功能, 适用于六角驱动螺丝
- 宽x高x深: 无工具344 x 30 x 392 mm、有工具344 x 45 x 392 mm

9726 泡垫 8007 B VDE Zyklop 3/8" VDE 棘轮组套 1



Code	EAN		
05150116001	4013288 232519		1
		<input type="checkbox"/> 8007 B VDE 1x 3/8"x222,0	
		<input type="checkbox"/> 410 i 电设用 B 1x 3/8"x130	
		<input checked="" type="checkbox"/> 8790 B VDE 1x 6,0x46,0; 1x 7,0x46,0; 1x 8,0x46,0; 1x 9,0x46,0; 1x 10,0x46,0; 1x 11,0x46,0; 1x 12,0x46,0; 1x 13,0x46,0; 1x 14,0x46,0; 1x 15,0x46,0; 1x 16,0x46,0; 1x 17,0x46,0; 1x 18,0x46,0; 1x 19,0x46,0	
		<input checked="" type="checkbox"/> 8767 B VDE HF 1x TX 20x55,0; 1x TX 25x55,0; 1x TX 27x55,0; 1x TX 30x55,0; 1x TX 40x55,0; 1x TX 45x59,0	
		<input checked="" type="checkbox"/> 8740 B VDE HF 1x 4,0x55,0; 1x 5,0x55,0; 1x 6,0x55,0; 1x 8,0x59,0	
		<input checked="" type="checkbox"/> 8794 SB VDE 1x 3/8"x91,0	
		<input checked="" type="checkbox"/> 8794 LB VDE 1x 3/8"x166,0	
		9826 1x 344,0x30,0x392,0	

*) 注意: 泡垫不适用于旧型号 05501051001 的车间手推车。

9730 泡垫 6000 Joker 组套 1

- 口内金属板使用的具有夹持功能的环形棘轮扳手
- 端挡无滑落
- 双六角形降低了滑落到侧面的风险
- 小至30°的回转角
- 带“易寻”色标系统,可轻松找到所需套筒
- 宽x高x深: 无工具172 x 30 x 392 mm、有工具 172 x 47 x 392 mm

9730 泡垫 6000 Joker 组套 1



Code	EAN		
05150120001	4013288 225214		1
		6000 Joker 1x 8x144; 1x 10x159; 1x 11x165; 1x 12x170,7; 1x 13x177; 1x 14x188; 1x 15x200; 1x 16x212; 1x 17x224; 1x 18x235; 1x 19x246	
		9830 1x 172,0x30,0x392,0 ¹⁾	

¹⁾ 注意: 泡垫不适用于旧型号 05501051001 的车间手推车。

9731 泡垫 6003 Joker 组套 1

- 环形扳手, 适用于小空间
- 特殊几何形状增加了工具的接触面
- 扳手开口的小回转角让所有螺丝在15°内完成适配
- 倾斜度为15°的狭长环形扳头
- 带“易寻”色标系统,可轻松找到所需套筒
- 标志性开瓶器与原始 Kraftform Plus 手柄
- 宽x高x深: 无工具344 x 30 x 392 mm、有工具 344 x 58 x 392 mm

9731 泡垫 6003 Joker 组套 1



Code	EAN		
05150121001	4013288 225115		1
		6003 Joker 1x 6x105; 1x 7x110; 1x 8x115; 1x 9x120; 1x 10x125; 1x 11x135; 1x 12x148; 1x 13x160; 1x 14x167; 1x 15x174; 1x 16x182; 1x 17x190; 1x 18x210; 1x 19x230; 1x 20x230; 1x 21x260; 1x 22x260; 1x 24x280	
		开瓶器 1x 145	
		9831 1x 344,0x30,0x392,0 ¹⁾	

¹⁾ 注意: 泡垫不适用于旧型号 05501051001 的车间手推车。

9732 泡垫 6004 Joker 组套 1

- 自调式Joker 6004能取代不同尺寸的开口扳手 (公制和英制)
- 自动和连续夹紧六角螺钉或螺栓
- 握紧时通过杠杆机构, 避免滑脱和产生损坏
- 借助杠杆棘轮功能, 无需取下扳手便可快速流畅完成螺丝紧固工序
- 开口凹槽设计实现 30° 回转角
- 宽x高x深: 无工具172 x 30 x 392 mm、有工具 172 x 35 x 392 mm

9732 泡垫 6004 Joker 组套 1



Code	EAN		
05150122001	4013288 225337		1
		6004 Joker XS 1x 7-10 (1/4"-3/8")x117	
		6004 Joker S 1x 10-13 (7/16"-1/2")x154	
		6004 Joker M 1x 13-16 (1/2"-5/8")x188	
		6004 Joker L 1x 16-19 (5/8"-3/4")x224	
		6004 Joker XL 1x 19-24 (3/4"-15/16")x256	
		9832 1x 172,0x30,0x392,0 ¹⁾	

¹⁾ 注意: 泡垫不适用于旧型号 05501051001 的车间手推车。

9733 泡垫 6001 Joker Switch 组套 1

- 换向式 6001 Joker Switch 棘轮组合扳手
- 棘轮端成15°角
- 夹口的金属挡板可提供实用的固持功能
- 限位挡块防止滑落
- 极小细齿和坚固的锁定机制
- 带 „易寻“ 色标系统, 可轻松找到所需套筒
- 宽x高x深: 无工具172 x 30 x 392 mm、有工具 172 x 48 x 392 mm

9733 泡垫 6001 Joker Switch 组套 1



Code	EAN		
05150123001	4013288 232496		1
		6001 Joker Switch 1x 8x144; 1x 10x159; 1x 11x165; 1x 12x171; 1x 13x179; 1x 14x187; 1x 15x199; 1x 16x213; 1x 17x225; 1x 18x234; 1x 19x246	
		9833 1x 172,0x30,0x392,0	

¹⁾ 注意: 泡垫不适用于旧型号 05501051001 的车间手推车。



9734 泡垫 6004 Joker VDE 组套 1

- 6004 Joker VDE XS, 适用于尺寸为 7-10 (公制) 或 1/4"-3/8" (英制) 的扳手; 6004 Joker VDE S, 适用于尺寸为 10-13 (公制) 或 7/16"-1/2" (英制) 的扳手; 6004 Joker VDE M, 适用于尺寸为 13-16 (公制) 或 1/2"-5/8" (英制) 的扳手; 6004 Joker VDE L, 适用于尺寸为 16-19 (公制) 或 5/8"-3/4" (英制) 的扳手
- 带有绝缘手柄的单独测试工具, 用于安全工作, 工作电压不超过 1,000 伏, 具有防滑保护功能, 可安全打开非绝缘钳口
- 自动无阻碍地夹紧六角螺栓和螺帽
- 握紧时通过杠杆机构, 避免滑脱和产生损坏
- 借助杠杆棘轮功能, 无需取下扳手便可快速流畅完成螺丝紧固工序
- 开口凹槽设计实现 30° 回转角
- 宽x高x深: 无工具172 x 30 x 392 mm、有工具 172 x 40 x 392 mm

9734 泡垫 6004 Joker VDE 组套 1

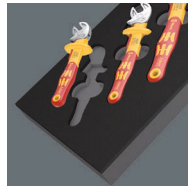

Code	EAN		
05150124001	4013288 232502		1
		6004 Joker VDE XS 1x 7-10 (1/4"-3/8")x119	
		6004 Joker VDE S 1x 10-13 (7/16"-1/2")x155	
		6004 Joker VDE M 1x 13-16 (1/2"-5/8")x190	
		6004 Joker VDE L 1x 16-19 (5/8"-3/4")x226	
		9834 1x 172,0x30,0x392,0	

¹⁾ 注意: 泡垫不适用于旧型号 05501051001 的车间手推车。

9740 泡垫 L 型扳手套组 1

- 由于其 Hex-Plus 型材, 950 L 型扳手使内六角螺丝的寿命更长
- “易寻”色标系统的所有 L 型扳手: 用特定颜色代表不同尺寸
- 所有的 L 型扳手都有一个彩色编码, 易于抓握的软管套筒, 即使在低温下也符合人体工学和舒适的操作
- 用于磁化和退磁工具尖端的着磁装置 9500, 以使用磁力将螺丝固定在工具上
- 宽x高x深: 无工具172 x 30 x 392 mm、有工具 172 x 44 x 392 mm

9740 泡垫 L 型扳手套组 1



Code	EAN		
05150140001	4013288 225108		1
		1x 950/9 Hex-Plus Multicolour 1	
		950 SPKL Multicolour 1x 1.5x90; 1x 2.0x101; 1x 2.5x112; 1x 3.0x123; 1x 4.0x137; 1x 5.0x154; 1x 6.0x172; 1x 8.0x195; 1x 10.0x224	
		1x 967/9 TX XL Multicolour 1	
		967 SXL TORX® Multicolour 1x TX 8x90; 1x TX 9x101; 1x TX 10x112	
		967 SPKXL TORX® Multicolour 1x TX 15x123; 1x TX 20x137; 1x TX 25x154; 1x TX 27x172; 1x TX 30x195; 1x TX 40x224	
		1x 9500	
		1x 48.0	
		1x STABILA®	
		1x STABILA® 袖珍卷尺 BM 100 · 3 m · 项目 19570	
		1x 9840	
		1x 172,0x30,0x392,0 ¹⁾	

¹⁾ 注意: 泡垫不适用于旧型号 05501051001 的车间手推车。

9750 泡垫 Kraftform Kompakt 和 Tool-Check PLUS 组套 1

- Kraftform Kompakt 60: 带 89 mm 长批头的折叠袋和 816 R 插换式螺丝刀、Rapidaptor 快速释放夹持和多重材料 Kraftform 手柄, 减轻疲劳
- Tool-Check PLUS: 棘轮、套筒和1个插换式螺丝刀的 39 件工具组合
- 在受限空间作业时, 采用软轴和极细设计的插换式螺丝刀超细
- 宽x高x深: 无工具172 x 30 x 392 mm、有工具 172 x 59 x 392 mm

9750 泡垫 Kraftform Kompakt 和 Tool-Check PLUS 组套 1



Code	EAN		
05150150001	4013288 225344		1
1x Tool-Check PLUS			
	⊖	8001 A 1x 1/4"x87.0	
	●	813 1x 1/4"x78	
	⊙	889/4/1 K 1x 1/4"x50	
	⊖	870/1 1x 1/4"x25 ¹⁾	
	●	8790 HMA 1x 5.5x23.0; 1x 6.0x23.0; 1x 7.0x23.0; 1x 8.0x23.0; 1x 10.0x23.0; 1x 12.0x23.0; 1x 13.0x23.0	
	+	851/1 TZ 2x PH 1x25; 3x PH 2x25; 1x PH 3x25	
	+	855/1 TH 1x PZ 1x25; 3x PZ 2x25; 1x PZ 3x25	
	⊕	867/1 TZ TORX® 1x TX 10x25; 1x TX 15x25; 1x TX 20x25; 1x TX 25x25; 1x TX 30x25; 1x TX 40x25	
	⊕	867/1 Z TORX® BO 1x TX 10x25; 1x TX 15x25; 1x TX 20x25; 1x TX 25x25; 1x TX 30x25	
	○	840/1 Z 1x 3.0x25; 1x 4.0x25; 1x 5.0x25; 1x 6.0x25; 1x 8.0x25	
	⊖	800/1 TZ 1x 1.0x5.5x25	
1x Kraftform Kompakt 60			
	●	816 R 1x 1/4"x119	
	+	851/4 Z 1x PH 1x89; 1x PH 2x89; 1x PH 3x89 ²⁾	
	+	855/4 Z 1x PZ 1x89; 1x PZ 2x89; 1x PZ 3x89 ²⁾	
	⊕	867/4 Z TORX® BO 1x TX 10x89; 1x TX 15x89; 1x TX 20x89; 1x TX 25x89; 1x TX 30x89	
	⊖	800/4 Z 1x 1.0x5.5x89	
	○	840/4 Z 1x 3.0x89; 1x 4.0x89; 1x 5.0x89; 1x 6.0x89 ²⁾	
		魔术贴 70 1x 50.0x70.0	
1x 393 S 差替式フレキシブルシャフトドライバー			
	●	1x 1/4"x173,5	
1x 9850			
		1x 172,0x30,0x392,0 ³⁾	

¹⁾ 带摩擦球, 用于手动螺母扳手套筒

²⁾ 六角形刀片

³⁾ 注意: 泡垫不适用于旧型号 05501051001 的车间手推车。









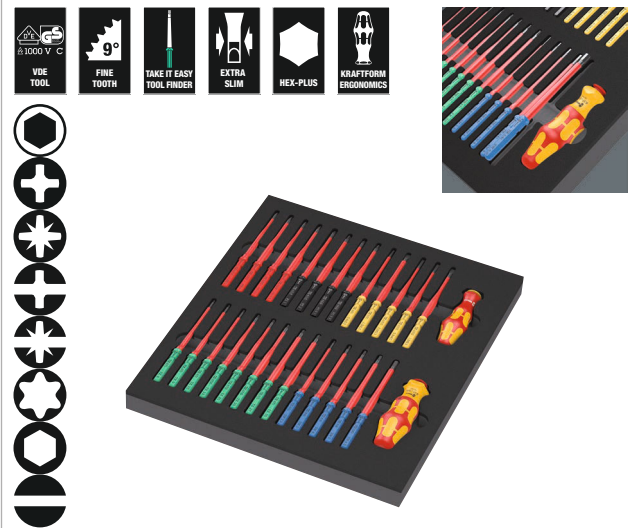





9751 泡垫 Kraftform Kompakt VDE 组套 1

- 具有棘轮功能的 837 i RA VDE 手柄; 适用于 Kraftform Kompakt
- 817 VDE 手柄, 适用于 Kraftform Kompakt 可更换式绝缘刀杆
- VDE 刀杆 (长 157 mm) 具有实用的旋转功能、防侧倾保护和“Take it easy”工具查找装置: 带有侧面彩色编码和激光雕刻尺寸指示
- 14 个可更换式绝缘刀杆, 缩短了刀杆直径并且带集成绝缘保护层 (iS)
- 配“Take it easy”易寻色标系统的可更换式绝缘刀杆: 带有侧面彩色编码和激光雕刻尺寸指示
- 宽x高x深: 无工具344 x 30 x 392 mm、有工具 344 x 46 x 392 mm

9751 泡垫 Kraftform Kompakt VDE 组套 1



Code	EAN		
	4013288		
05150151001	232526		1
		 837 i RA 1x 9x115	
		 817 VDE 1x 9x98	
		 Kraftform Kompakt VDE 62 iS Take it easy 1x PH 1x157; 1x PH 2x157	
		 Kraftform Kompakt VDE 65 iS Take it easy 1x PZ 1x157; 1x PZ 2x157	
		 Kraftform Kompakt VDE 62 i PH/S Take it easy 1x # 1x157; 1x # 2x157	
		 Kraftform Kompakt VDE 65 iS PZ/S Take it easy 1x # 1x157; 1x # 2x157	
		 Kraftform Kompakt VDE 67 i Take it easy 1x TX 8x157; 1x TX 9x157; 1x TX 10x157; 1x TX 27x157; 1x TX 30x157	
		 Kraftform Kompakt VDE 67 iS Take it easy 1x TX 15x157; 1x TX 20x157; 1x TX 25x157	
		 Kraftform Kompakt VDE 64 i Take it easy 1x 2,5x157; 1x 3,0x157; 1x 4,0x157; 1x 5,0x157; 1x 6,0x157	
		 Kraftform Kompakt VDE 60 iS Take it easy 1x 0,6x3,5x157; 1x 0,8x4,0x157; 1x 1,0x5,5x157	
		 Kraftform Kompakt VDE 60 i Take it easy 1x 0,4x2,5x157; 1x 1,2x6,5x157	
		9851 1x 344,0x30,0x392,0	

^{*)} 注意: 泡垫不适用于旧型号 05501051001 的车间手推车。

9752 泡垫 Kraftform Kompakt 棘轮组套 1

- 838 RA-R M 插换式螺丝刀, 具有集成棘轮功能 (细齿, 36 齿, 回转角 10°), 适用于 1/4" 批头
- 416 RA T 形柄插换式螺丝刀, 具有集成棘轮 (细齿, 80 齿, 回转角 4,5°), 适用于 1/4" 批头
- 符合人体工学的双重材料 T 型柄
- 816 R 插换式螺丝刀, 带人体工学 Kraftform 手柄和 Rapidaptor 快速脱落卡盘, 适用于 1/4" 批头
- Rapidaptor 快速接杆用于快速更换批头; 带强力磁铁
- Zyklon 8001 A 迷你批头棘轮 (60 齿, 回转角 6°), 采用落锻实心钢设计; 适用于 1/4" 批头, 带 1/4" 套筒适配器
- 用于手动操作套筒的 870/1 连接部件; 可适配 1/4" 外六角至 1/4" 外四角头
- 用于工用于工具尖端加磁和消磁的磁化装置 9500
- 通用型硬批头
- 宽x高x深: 无工具 172 x 30 x 392 mm、有工具 172 x 42 x 392 mm

9752 泡垫 Kraftform Kompakt 棘轮组套 1

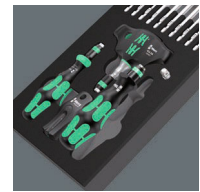

Code	EAN		
	4013288		
05150152001	232533		1
			838 RA-R M 1x 1/4"x123,5
			416 RA 1x 1/4"x45
			816 R 1x 1/4"x119
			8001 A 1x 1/4"x87,0
			851/4 Z 1x PH 1x89; 1x PH 2x89; 1x PH 3x89 ¹⁾
			855/4 Z 1x PZ 1x89; 1x PZ 2x89; 1x PZ 3x89 ¹⁾
			867/4 Z TORX® 1x TX 10x89; 1x TX 15x89; 1x TX 20x89; 1x TX 25x89; 1x TX 27x89; 1x TX 30x89; 1x TX 40x89
			840/4 Z 1x 3,0x89; 1x 4,0x89; 1x 5,0x89; 1x 6,0x89 ¹⁾
			800/4 Z 1x 1,0x5,5x89
			870/1 1x 1/4"x25 ²⁾
			9500 1x 64,6
			9852 1x 172,0x30,0x392,0

¹⁾ 六角形刀片

²⁾ 带摩擦球, 用于手动螺母扳手套筒

³⁾ 注意: 泡垫不适用于旧型号 05501051001 的车间手推车。



9780 泡垫 KNIPEX 钳组套 1

- 宽x高x深: 无工具172 x 30 x 392 mm、有工具
172 x 38 x 392 mm

9780 泡垫 KNIPEX 钳组套 1



Code	EAN		
	4013288		
05150180001	225153		1
		KNIPEX 钢丝平嘴老虎钳 03 05 180 1x 180	
		KNIPEX Cobra® 高科技水泵钳 87 05 250 1x 250	
		KNIPEX 省力斜口钳 74 05 160 1x 160	
		9880 1x 172,0x30,0x392,0 ¹⁾	

¹⁾ 注意: 泡垫不适用于旧型号 05501051001 的车间手推车。

9781 泡垫 KNIPEX 钳组套 2

- 宽x高x深: 无工具172 x 30 x 392 mm、有工具
172 x 38 x 392 mm

9781 泡垫 KNIPEX 钳组套 2



Code	EAN		
	4013288		
05150181001	225177		1
		KNIPEX 尖嘴钳26 15 200 1x 200	
		KNIPEX 机工用钳 38 25 200 1x 200	
		KNIPEX 不锈钢电工剪 95 05 155 1x 155	
		9881 1x 172,0x30,0x392,0 ¹⁾	

¹⁾ 注意: 泡垫不适用于旧型号 05501051001 的车间手推车。

9782 泡垫锤组套 1

- 宽x高x深: 无工具172 x 30 x 392 mm、有工具
172 x 35 x 392 mm

9782 泡垫锤组套 1



Code	EAN		
	4013288		
05150182001	225191		1
		PICARD® 铆钉锤500g · 0000101-500 1x 500,0	
		RENNSTEIG 限量穿孔工具 1x 452 003 6 RC, 3,0x150; 1x 452 004 6 RC, 4,0x150; 1x 452 006 6 RC, 6,0x150; 1x 452 008 6 RC, 8,0x150	
		RENNSTEIG 平头凿 310 250 1 1x 25,0x13,0x23,0	
		9882 1x 172,0x30,0x392,0 ¹⁾	

¹⁾ 注意: 泡垫不适用于旧型号 05501051001 的车间手推车。

9783 泡垫 PFERD 锉刀组套 1

- 宽x高x深: 无工具344 x 30 x 392 mm、有工具
344 x 42 x 392 mm

9783 泡垫 PFERD 锉刀组套 1

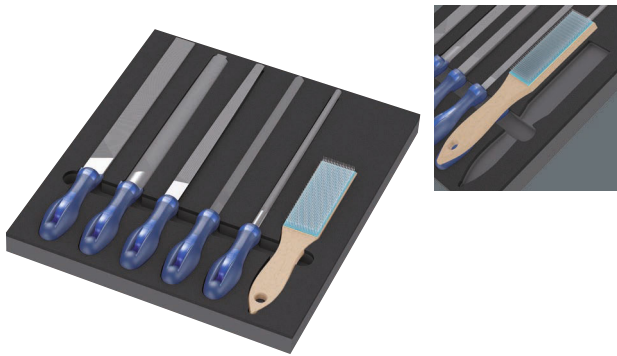

Code	EAN		
05150183001	4013288 225368		1
		PFERD 机工用方锉 PF1142 250 H2 1x 250	
		PFERD 机工用半圆尖头锉 1152SP 250 H2 1x 250	
		PFERD 机工用圆锉 1162 250 H2 1x 250	
		PFERD 机工用手锉 1112 250 H2 1x 250	
		PFERD 机工用三角锉 1132 250 H2 1x 250	
		PFERD 刮刷 HBF 钢丝直径不小于 0.15 1x 232	
		9883 1x 344,0x30,0x392,0 ¹⁾	

¹⁾ 注意: 泡垫不适用于旧型号 05501051001 的车间手推车。

9784 泡垫 KNIPEX 钳组套 VDE 1

- 宽x高x深: 无工具172 x 30 x 392 mm、有工具
172 x 38 x 392 mm

9784 泡垫 KNIPEX 钳组套 VDE 1



Code	EAN		
05150184001	4013288 232489		1
		KNIPEX 斜口钳 70 06 160	
		KNIPEX 鹅嘴钳·含刀杆(鹅嘴钳) 26 16 200	
		KNIPEX 鲤鱼钳 08 26 185	
		9884 1x 172,0x30,0x392,0	

¹⁾ 注意: 泡垫不适用于旧型号 05501051001 的车间手推车。





Wera 2go



Wera 2go 1 便携组合

Wera 2go便携组合, 带有魔术贴, 便于收纳维拉织物箱包。可自由调节盒内构造来提供更灵活的收纳空间。肩背, 无需手拎, 包含一个可调节可拆卸的带垫肩的肩带。

工具箱包内外部均有魔术贴, 可以轻松与其他Wera 2go组件贴合, 且可自由调整特定工作所需的工具收纳容器。

- Wera 2go 件拎把, 带双面魔术贴
- 和维拉其他织布箱/包连接组合并附带可拆装肩带的吊环
- 且可自由调整特定工作所需的工具收纳容器。
- 手臂和手部仍可以自由活动
- 附带可调整长短和可拆装的肩带和肩垫

Wera 2go 1 便携组合



Code	EAN		
05004350001	187352		1
		Wera 2go 5 1x 135,0x300,0x270,0	
		Wera 2go 6 1x 38,0x1470,0	

Wera 2go 2 工具包

Wera 2go工具包, 箱内外均带有魔术贴。可自由调节盒内构造, 提供更灵活的收纳空间。

方便收纳及取用其他带魔术贴的维拉织物箱包。

肩背, 无需手拎。坚固耐用的材料, 耐刀割及穿刺, 能保护其所携带的工具免于损伤或受潮, 也可延长工具箱包的使用寿命。

工具箱包内外部均有魔术贴, 可以轻松与其他Wera 2go组件贴合, 且可自由调整特定工作所需的工具收纳容器。

工具箱包内可灵活调整的内装隔间使得空间被有效利用也使得工具可以被分类收纳。

- 件寸不易变形且耐用的工具箱 (空), 带魔术贴
- 且可自由调整特定工作所需的工具收纳容器。
- 和维拉其他织布箱/包连接组合并附带可拆装肩带的吊环

Wera 2go 2 工具包



Code	EAN		
05004351001	187840		1
		Wera 2go Container 1x 355,0x330,0x115,0	
		Wera 2go 6 1x 38,0x1470,0	
		Wera 2go 4 1x 165,0x165,0x105,0	

Wera 2go 2 XL 工具包

Wera 2go 2 XL工具容器具有可调整式隔间, 采用吊钩和环扣系统, 设计紧凑, 是单个工具便捷运输的理想解决方案。内部和外部吊钩和环扣区域可提供极高的灵活性和空间利用率。

由此可在容器内和容器上放置数量可观的工具。Wera 2go 2可使行李变轻, 因为仅需要携带必要的工具。经久耐用且坚固的材料, 可保护收纳的工具不出现损坏和受潮, 同时提高了工具容器的使用寿命。

带保护垫且可调节的宽型肩带, 以及紧凑可调整的隔间, 提供了舒适的使用体验。在携带过程中, 双手可自由活动。随附1个Wera 2go 4工具收纳包, 单个可调节的吊钩和环扣, 可用于螺丝刀和其他工具。

4个可以轻松收纳起来的环扣。

- Wera 2go 2 XL工具容器, 配备可调整式隔间, 例如用于放置Wera 2go 4收纳包

Wera 2go 2 XL 工具包



Code		EAN									
05004357001		211491								1	
				Wera 2go XL Container		1x 455,0x330,0x170,0					
				Wera 2go 6		1x 38,0x1470,0					
				Wera 2go 4		1x 165,0x165,0x105,0					

Wera 2go 3 工具箱

- 可以和其他Wera 2go系列产品组合使用
- 具有织物内衬的塑料面板可保证其坚固稳定。
- 耐刀割及穿刺
- 有效防止工具在运输工程中受损或受潮
- 可单独使用

Wera 2go 3 工具箱



Code		EAN		mm		mm		mm			
05004352001		187369		130,0		325,0		80,0		1	

Wera 2go 4 工具袋

- 可以和其他Wera 2go系列产品组合使用
- 尺寸不易变形
- 耐刀割及穿刺
- 可灵活调整的内装隔间可制造最多5个隔间
- 宽整的底部区域和可供提取和挂放的手提带

Wera 2go 4 工具袋



Code		EAN		mm		mm		mm			
05004353001		187857		165,0		165,0		105,0		1	

Wera 2go 5 拎袋

工具箱包内外部均有魔术贴,可以轻松与其他Wera 2go组件贴合,且可自由调整特定工作所需的工具收纳容器。

Wera 2go 5 拎袋



Code		EAN		mm		mm		mm			
05004354001		187383		135,0		300,0		270,0		1	

Wera 2go 6 肩带

肩带和止滑垫可将工具挂在肩上,使得手臂和手部可以自由活动。可调整位置的肩垫使您背起来自在方便。

Wera 2go 6 肩带



	EAN						
Code	4013288	mm	mm				
05004355001	187390	38,0	1470,0				1

Wera 2go 7件加长工具包

- 适合携带运输较长工具 (如水平尺) 的工具箱

Wera 2go 7件加长工具包



	EAN						
Code	4013288	mm	mm	mm			
05004356001	204370	295,0	100,0	100,0			1

Wera 2go H 1 工具套装 · 木工

紧凑型工具套装, 收纳了134种重要的专业木工使用工具, 涵盖的品牌包括Wera, BESSEY®, “KIRSCHEN”®, KNIPEX, Lyra®, PICARD®, 和 Stabila®。

帆布包装, 帆布包带魔鬼粘和环扣系统, 可安装黏贴到墙壁、柜子、车间用滚轮小车和Wera 2go 系列产品。

- 134件装扩展工具套装, 采用紧凑的Wera 2go工具容器, 适合在外工作的木工使用
- 高质量品牌工具涵盖的产品系列包括Wera, BESSEY®, KNIPEX, “KIRSCHEN”®, Lyra®, PICARD® 和 Stabila®
- Wera Kraftform Kompakt H 1 木制(41件装) 和 Wera Bit-Safe 61 木制 1 (61件装)
- 393 S 超薄批头手动固持器, 具有活动轴身, 适合在难以到达的工作空间内使用
- Wera L型扳手具有固持功能: 967/9 TX XL 多色彩 HF 1 (9 件装) 和 950/9 Hex-Plus 多色彩 HF 1 (9 件装)

Wera 2go H 1 工具套装 · 木工



Code	EAN		
	4013288		
05134011001	217677		1
		1x Wera 2go 2	
		1x Bit-Safe 61 Wood 1	
		1x Kraftform Kompakt H 1	
		1x 967/9 TX XL Multicolour HF 1	
		1x 950/9 Hex-Plus Multicolour HF 1	
		1x 393 S 插换式软轴螺丝刀 1/4"x173,5	
		1x KNIPEX 木工钳 210mm 50 00 210	
		1x Stabila® 水平仪 81 式 25cm 02500 Torpedo	
		1x 木工锤105mm 52-1 P	
		1x “KIRSCHEN”® 凿子 10mm 1001010	
		1x “KIRSCHEN”® 凿子 16mm 1001016	
		1x “KIRSCHEN”® 凿子 20mm 1001020	
		1x “KIRSCHEN”® 凿子 26mm 1001026	
		1x Stabila® 木质折叠尺 601 式 N-S 2m 18206	
		1x Picard 木工锤 400g · 法式 0008501-28	
		1x KNIPEX 水泵钳 COBRA® 250mm 87 11 250	
		1x KNIPEX 万用钳 160mm 03 01 160	
		1x BESSEY® 刀片 DBKPH-EU 弹簧刀	

未在美国和加拿大上市

维拉 2go E 1 电工工具组套

紧凑工具组, 含 73 件最重要的电工工具, 产品由 维拉、Jung、KNIPEX、Lyra®、PICARD®、PUK® 和 Stabila® 提供。

维拉 2go 系统采用紧凑型工具容器设计, 产品易于携带。

- 丰富的 73 件工具组套置于紧凑型 维拉 2go 2 便携组合内, 用于电工便携作业
- 维拉、Jung®、KNIPEX、Lyra®、PICARD®、PUK® 和 Stabila® 提供优质品牌工具
- 维拉 Kraftform Kompakt Turbo i 1 Tool Finder (16 件手柄/可更换刀杆电设用组套) 将拧紧效率提高 4 倍, 和 维拉 8100 SA 6 Zyklop Speed 棘轮组套 (1/4" 驱动, 28 件组套)
- Joker 6004 S 开口自调式扳手, 用于 10-13mm (公制) 和 7/16"-1/2" 驱动 (英制) 的螺栓和螺丝
- 配槽用螺丝刀, 用于锁螺丝、凿边和榫接和 4 件电设用螺丝刀 - 其中 2 件配不锈钢刀杆, 防止外部锈蚀

维拉 2go E 1 电工工具组套



Code	EAN		
	4013288		
05134025001	221278	1 x Wera 2go 2 工具包	1
		1 x 8100 SA 6 Zyklop Speed 棘轮扳手组套 · 1/4" 驱动 · 公制	
		1 x 950/9 Hex-Plus Multicolour HF 1 公制内六角 L 型扳手组套 · 彩色 · 激光表面处理 · 带固持功能 · 公	
		1 x Kraftform Kompakt Turbo i 1 Tool Finder	
		1x 932 A 一字螺丝刀 1.2x7.0x125	
		1x 3162 i PH VDE 不锈钢十字绝缘螺丝刀 PH 2x100	
		1x 3165 i PZ VDE 不锈钢米字绝缘螺丝刀 PZ 2x100	
		1x 160 i VDE 一字绝缘螺丝刀 1.2x6.5x150	
		1x 160 iS VDE 一字绝缘螺丝刀 · 小直径刀杆 0.6x3.5x100	
		1x 6004 Joker S 自调式开口扳手 10-13x7/16"-1/2"x154	
		1 x KNIPEX 万用钳 160mm 01 06 160	
		1 x KNIPEX 斜口绝缘剥离器 14 26 160	
		1 x KNIPEX 鹬嘴钳 · 含刀杆 (鹬嘴钳) 26 16 200	
		1 x KNIPEX Cobra® 电设用 高科技水泵钳 · 绝缘 · 87 26 250	
		1 x KNIPEX 电缆刀 98 52	
		1 x KNIPEX ErgoStrip® 通用拆卸工具 16 95 01	
		1 x PUK® 2200 手锯	
		1 x Lyra® 施工标记用笔 4494202	
		1 x STABILA® 口袋型电动水平仪 17775	
		1 x STABILA® 水平仪 70 式 · 30 cm · 02281	
		1 x STABILA® 木质折叠尺 607 式 · 2 m · 淡黄色 · 01104	
		1 x PICARD® 钳工锤 400 g · 德式 · 000101-0400	
		1 x Jung Plastering 搅拌杯 127mm · 946 127 00	
		1 x Jung Scraping 刀 · 配天然木柄 · 922 050 00	



Wera 2go SHK 1 工具组套 · 用于管道、供暖和空调操作

紧凑型工具组套, 含最重要的电工工具, 产品由 Wera、BESSEY®、KNIPEX、Lyra®、PICARD®、PUK® 和 Stabila® 提供。Wera 2go 系统采用紧凑型工具容器设计, 产品易于携带。

- 丰富的 30 件工具组套置于紧凑型 Wera 2go 2 便携组合内, 用于暖通空调应用
- Wera、BESSEY®、KNIPEX®、Lyra®、PICARD®、PUK® 和 Stabila® 提供优质品牌工具
- 口内金属板使用的具有实际夹持功能的 Joker 6002 双扳手
- 配槽用螺丝刀, 用于锁螺丝、凿边和榫接和 4 件电设用螺丝刀 - 其中 2 件配不锈钢刀杆, 防止外部锈蚀
- 1/2" Zyklop 金属 8004 C 棘轮 (72 齿, 5° 回转角低), 带转向杆; 超薄设计, 适合非常狭窄的空间
- 内六角螺丝的 L 型扳手套套; Hex-Plus 外形减少了内六角螺丝的外圆旋转

Wera 2go SHK 1 工具组套 · 用于管道、供暖和空调操作



Code	EAN	
05136071001	4013288 230300	1 
		1x Wera 2go Container
		1x Wera 2go 6 肩带
		1x Wera 2go 4 工具袋
		1x 932 A 一字螺丝刀 1.2x7.0x125
		1x 395 H0 螺帽螺丝刀 10.0x90
		1x 395 H0 螺帽螺丝刀 13.0x90
		1x 1060 i 电设用 绝缘 Kraftform 一字螺丝刀 0.6x3.5x100
		1x 1060 i 电设用 绝缘 Kraftform 一字螺丝刀 1.0x5.5x125
		1x 1062 i 十字 电设用 绝缘 Kraftform 十字螺丝刀 PH 1x80
		1x 1062 i 十字 电设用 绝缘 Kraftform 十字螺丝刀 PH 2x100
		1x 8004 C Zyklop Metal 拨杆换向棘轮扳手 · 1/2" 驱动 1/2"x281
		1x 8790 HMC Zyklop 套筒 · 1/2" 驱动 10.0x37.0
		1x 8790 HMC Zyklop 套筒 · 1/2" 驱动 13.0x37.0
		1x 8790 HMC Zyklop 套筒 · 1/2" 驱动 17.0x37.0
		1x 8790 HMC Zyklop 套筒 · 1/2" 驱动 19.0x37.0
		1x 套筒条带 (织物带) C · 6个位置 45.0x275.0
		1x 6002 Joker 双开口扳手 10x13x167
		1x 6002 Joker 双开口扳手 17x19x235
		1x 6002 Joker 双开口扳手 24x27x280
		1x 6002 Joker 双开口扳手 30x32x305
		1x 950/9 Hex-Plus 2
		1x 9529 C SB 散热器用5阶扳手 1/2" 10.0x88,0
		1x KNIPEX 水泵钳 COBRA® 250mm 87 11 250
		1x KNIPEX 万用钳 160mm 03 01 160
		1x KNIPEX 斜口绝缘剥离器 14 26 160
		1x 用于标准关闭系统的 KNIPEX 001104 Pro 扳手
		1x STABILA® 水平仪 70 式 · 30 cm · 02281
		1x STABILA® 木质折叠尺 607 式 · 2 m · 淡黄色 · 01104
		1x PICARD® 钳工锤 400 g · 德式 · 000101-0400
		1x PUK® 2200 手锯
		1x BESSEY® 刀片 DBKPH-EU 弹簧刀
		1x Lyra® 施工标记用笔 4494202

魔术贴 1



Code	EAN		
05670446001	4013288 189448		1
		魔术贴 70 1x 50,0x70,0	

魔术贴 2



Code	EAN		
05670447001	4013288 189455		1
		魔术贴 120 1x 50,0x120,0	

魔术贴 3



Code	EAN		
05670448001	4013288 189462		1
		魔术贴 240 1x 50,0x240,0	





批头



抗冲击系统 – 为了极限需求而设计



超长使用寿命。对材料特性的有效利用，专为满足超常规需要而开发的特殊外形，以及特定的制造流程，这些特点成就了维拉冲击工具的超长使用寿命。冲击批头的头部涂敷了微小的金刚石颗粒，使产品更加有优势。这些金刚石颗粒可降低滑脱影响（使用电动工具时出现几率尤高），这种滑脱可能导致螺丝头滑出。

金刚石颗粒能够“咬”紧螺丝头部，这就意味着所需接触压力更小，大大延迟了电动工具螺丝拆卸作业的疲劳开始时间。

851/1 IMP DC 十字 DIY Impaktor 十字 批头



Code	EAN			
05057615001	178695	+	851/1 IMP DC 10x PH 1x25	1
05057616001	157638	+	851/1 IMP DC 10x PH 2x25	1
05057617001	157645	+	851/1 IMP DC 10x PH 3x25	1

851/1 IMP DC 十字螺丝冲击批头吊卡装



Code	EAN			
05073916001	158369	+	851/1 IMP DC 1x PH 2x25	5
05073917001	158376	+	851/1 IMP DC 1x PH 3x25	5

Bit-Box 15 Impaktor PH 批头盒



Code	EAN			
05057752001	187918	+	851/1 IMP DC 15x PH 2x25	10

Kraftform 不锈钢系列 – 避免生锈

维拉的不锈钢工具通过真空冰处以达到所需硬度和强度，可满足工业级别的应用。



维拉不锈钢批头是由不锈钢材料制成，可有效避免锈蚀。维拉的不锈钢批头通过真空冰淬以达到所需硬度和强度，可满足工业级别应用。生锈问题的解决方案：使用不锈钢工具拆装不锈钢螺丝。维拉不锈钢工具是由不锈钢材料制成，可有效避免难看的锈蚀。抗扭批头通过缩小中间杆部的直径，让批头抵抗冲击的能力有显著提高，从而避免提早失效的情况。

3851/1 TS 不锈钢十字螺丝批头

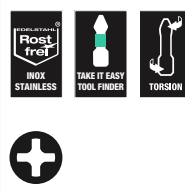

Code	EAN	+	mm	inch				
05071010001	110985	+	PH 1	25	1"			10
05071011001	110992	+	PH 2	25	1"			10
05071012001	111005	+	PH 3	25	1"			10

3851/1 TS SB 不锈钢批头



Code	EAN			
	4013288			
05073610001	112132	+	3851/1 TS PH 1x PH 1x25	5
05073611001	112149	+	3851/1 TS PH 1x PH 2x25	5

双重抗扭系统 – 给您更长的应用周期

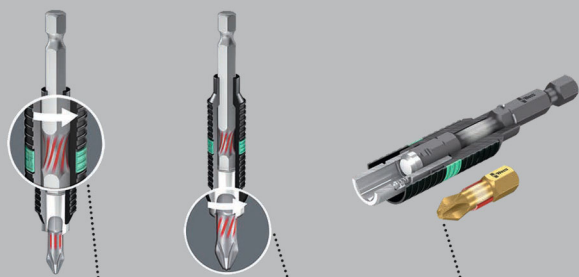

双重抗扭设计 接杆吸收一小部分扭力

大部分的扭力会被批头上标示的双重抗扭区吸收

正常使用下的扭力冲击，并不会造成不必要的磨损

851/1 BDC 十字螺丝批头

BiTorsion 批头，用于十字螺丝，尖部带细微金刚石颗粒。由此确保批头在螺丝内配合到位，减少所需的接触压力，并降低打滑风险。

带扭力区，可在峰值负荷状态下分散动能。由此极大延长了产品使用寿命；1/4"六角，适用于符合 DIN ISO 1173-F 6.3 标准的固持器。

851/1 BDC 十字螺丝批头



Code	EAN	+	六角	长度					
	4013288		mm						
05056400001	033970	PH 1	25	1"					10
05056402001	033987	PH 2	25	1"					10
05056404001	033994	PH 3	25	1"					10

851/1 BDC 十字螺丝批头吊卡装



Code	EAN	+		
	4013288			
05073332001	029324	+	851/1 BDC PH 1x PH 1x25	5
05073333001	029331	+	851/1 BDC PH 1x PH 2x25	5
05073334001	029348	+	851/1 BDC PH 1x PH 3x25	5
05073335001	029355	+	851/1 BDC PH 2x PH 2x25	5

851/1 BTH 十字螺丝批头

适用于十字螺丝的高质量批头，带扭力区，可在峰值负荷状态下分散动能。

由此极大延长了产品使用寿命。超高硬度设计；1/4"六角，适用于符合 DIN ISO 1173-D 6.3 标准的固持器。

851/1 BTH 十字螺丝批头



Code	EAN	+	六角	长度					
	4013288		mm						
05056410001	034243	PH 1	25	1"					10
05056412001	034250	PH 2	25	1"					10
05056414001	034267	PH 3	25	1"					10



851/1 BTZ 十字螺丝批头

适用于十字螺丝的尊享优质批头,带扭力区,可在峰值负荷状态下分散动能。由此显著提升了产品使用寿命。

坚固,适合通用型应用。1/4"六角,适用于符合 DIN ISO 1173-D 6.3 的固持器。

851/1 BTZ 十字螺丝批头



	EAN	+	mm	inch			
Code	4013288		mm	inch			
05056420001	034458	PH 1	25	1"			10
05056422001	034465	PH 2	25	1"			10
05056424001	034472	PH 3	25	1"			10

Bit-Box 20 BTZ PH 批头盒



Code	EAN	+					
05057751001	187956	+	851/1 BTZ PH 20x PH 2x25				10

金刚石涂层批头

分布在批头尖端的超微金刚石粉末 实实在在的咬合力

批头和螺丝凹槽稳固的贴合

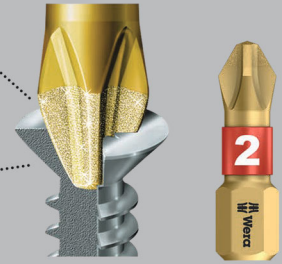

金刚石涂层批头的头部涂敷了微小的金刚石颗粒,能够“咬”紧螺丝头部,有效地降低了操作时滑脱的危险。同时,操作时保持在螺丝上的压力需求也大大降低。机加。

1/4"六角,适用于DIN ISO 1173-D 6.3标准的批头接头。

851/1 A 十字螺丝批头

A代表航空。该批头在工作部位保留了锋利的棱角,以便于穿透油漆涂层,保证螺丝和批头之间有可靠的动力传输。硬度更高,机加工。

851/1 A 十字螺丝批头



	EAN	+	mm	inch	mm		
Code	4013288		mm	inch	mm		
05134919001	099976	PH 1	25	1"	4,5		10
05134920001	099983	PH 2	25	1"	6,0		10
05134921001	099990	PH 3	25	1"	-		10

851/1 RDC 十字螺丝批头

细杆批头能保证不伤害工作面的前提下,进入工作面以下的螺丝孔工作。

金刚石涂层批头的头部涂敷了微小的金刚石颗粒,能够“咬”紧螺丝头部,有效地降低了操作时滑脱的危险。

同时,操作时保持在螺丝上的压力需求也大大降低。

851/1 RDC 十字螺丝批头



	EAN	+	mm	inch	mm		
Code	4013288		mm	inch	mm		
05135008001	032904	PH 2	25	1"	4,2		10

851/1 RH 十字螺丝批头

细杆批头能保证不伤害工作面的前提下, 进入工作面以下的螺丝孔工作。硬度更高, 加磨版。

851/1 RH 十字螺丝批头



	EAN	+	⌀	ℓ	ℓ	∅			
Code	4013288		mm			mm			
05346281001	107176	PH 2	25	1"	4,2				10

851/1 RZ 十字螺丝批头

细杆批头能保证不伤害工作面的前提下, 进入工作面以下的螺丝孔工作。具有韧性, 通用型。

851/1 RZ 十字螺丝批头



	EAN	+	⌀	ℓ	ℓ	∅			
Code	4013288		mm			mm			
05135009001	032799	PH 2	25	1"	4,2				10

851/1 RZ 十字螺丝批头吊卡装



Code	EAN	+							
05135005001	038456								
			851/1 RZ PH						
			2x PH 2x25						5

851/1 TH 十字螺丝批头

TH抗扭批头通过杆部的较小直径, 让批头抵抗冲击的能力有显著提高, 从而避免提早崩坏的情况。

851/1 TH 十字螺丝批头



	EAN	+	⌀	ℓ	ℓ	∅			
Code	4013288		mm						
05056605001	013545	PH 1	25	1"					10
05056610001	013552	PH 2	25	1"					10
05056625001	013569	PH 3	25	1"					10

851/1 TiN 十字螺丝批头

TiN代表镀钛。此批头的涂层使其适应连续生产的能力更强。

851/1 TiN 十字螺丝批头



	EAN	+	⌀	ℓ	ℓ	∅			
Code	4013288		mm						
05480172001	040992	PH 2	25	1"					10



851/1 TZ 十字螺丝批头

- 坚固而具有韧性, 用于坚硬材料
- 抗扭设计, 避免早期磨损

851/1 TZ 十字螺丝批头



	EAN	+	⌀	ℓ				
Code	4013288		mm					
05056505001	013606	PH 1	25	1"				10
05056510001	013613	PH 2	25	1"				10
05056525001	013620	PH 3	25	1"				10

851/1 TZ 十字螺丝批头吊卡装



Code	EAN	+						
	4013288							
05073323001	029249	+	851/1 TZ PH	2x PH 1x25				5
05073324001	029256	+	851/1 TZ PH	2x PH 2x25				5
05073325001	029263	+	851/1 TZ PH	2x PH 3x25				5
05073326001	029270	+	851/1 TZ PH	1x PH 1x25; 1x PH 2x25; 1x PH 3x25				5

853/1 TZ ACR® 十字螺丝批头

ACR®是专门用于降低螺丝打滑的设计。批头头部的刻纹跟螺丝头槽互相咬合, 有效降低操作时打滑的可能。TZ 抗扭批头通过杆部的较小直径, 让批头抵抗冲击的能力有显著提高, 从而避免提早崩坏的情况。维拉设计的缓冲吸收型批头能避免批头头部的早期断裂。该批头可通过产品目录中的产品字母Z来识别。

853/1 TZ ACR® 十字螺丝批头



	EAN	+	⌀	ℓ				
Code	4013288		mm					
05056662001	014405	PH 2	25	1"				10

851/1 Z 十字螺丝批头

- 坚固而具有韧性, 用于坚硬材料

851/1 Z 十字螺丝批头



	EAN	+	⌀	ℓ				
Code	4013288		mm					
05056500001	013323	PH 0	25	1"				10
05072070001	013453	PH 1	25	1"				10
05056507001	013330	PH 1	50	2"				10
05072072001	013460	PH 2	25	1"				10
05056515001	013347	PH 2	32	1 1/4"				10
05056520001	013354	PH 2	50	2"				10
05072074001	013477	PH 3	25	1"				10
05134905001	094858	PH 3	50	2"				10
05056535001	013378	PH 4	32	1 1/4"				10

851/1 Z 十字螺丝批头吊卡装



Code	EAN	+						
	4013288							
05073304001	029058	+	851/1 Z PH	2x PH 1x25				5
05073305001	029065	+	851/1 Z PH	2x PH 2x25				5
05073306001	029072	+	851/1 Z PH	2x PH 3x25				5
05073307001	029089	+	851/1 Z PH	1x PH 1x25; 1x PH 2x25; 1x PH 3x25				5

851/1 Z DIY 批头



Code	EAN	+						
	4013288							
05072400001	115737	+	851/1 Z PH	10x PH 1x25				1
05072401001	115744	+	851/1 Z PH	10x PH 2x25				1
05072402001	115751	+	851/1 Z PH	10x PH 3x25				1

851/1 Z DIY 100 十字螺丝批头



Code	EAN			
05072441001	4013288 138477		851/1 Z PH 100x PH 2x25	1

Bit-Box 20 PH 批头盒



Code	EAN			
05057750001	4013288 188014		851/1 Z PH 20x PH 2x25	20

851/1 J 十字螺丝批头

J代表日本。此批头专门设计用于亚洲常用的小规格十字螺丝，这种小规格十字螺丝常见于日工业规格。

851/1 J 十字螺丝批头



	EAN						
Code	4013288		mm	"	mm		
05135040001 ¹⁾	112569		PH 00	25	1"	2,0	10
05135041001 ²⁾	112576		PH 0	25	1"	2,5	10

¹⁾ 尺寸00根据JCS 00 (日本相机工业标准) 修改

²⁾ 尺寸0根据JCS 0 (日本相机工业标准) 修改

抗冲击系统 – 为了极限需求而设计



超长使用寿命。对材料特性的有效利用，专为满足超常规需要而开发的特殊外形，以及特定的制造流程，这些特点成就了维拉冲击工具的超长使用寿命。冲击批头的头部涂敷了微小的金刚石颗粒，使产品更加有优势。这些金刚石颗粒可降低滑脱影响（使用电动工具时出现几率尤高），这种滑脱可能导致螺丝头滑出。金刚石颗粒能够“咬”紧螺丝头部，这就意味着所需接触压力更小，大大延迟了电动工具螺丝拆卸作业的疲劳开始时间。

851/4 IMP DC 十字 DIY Impaktor 十字 批头



Code	EAN			
05057656001	4013288 157652		851/4 IMP DC 5x PH 2x50	1
05057657001	157669		851/4 IMP DC 5x PH 3x50	1



851/4 IMP DC 十字螺丝冲击批头吊卡装



Code	EAN			
	4013288			
05073956001	158482		851/4 IMP DC 1x PH 2x50	5
05073957001	158499		851/4 IMP DC 1x PH 3x50	5

Kraftform 不锈钢系列 – 避免生锈

维拉的不锈钢工具通过真空冰处以达到所需硬度和强度，可满足工业级别的应用。

不锈钢材质避免外因锈蚀形成

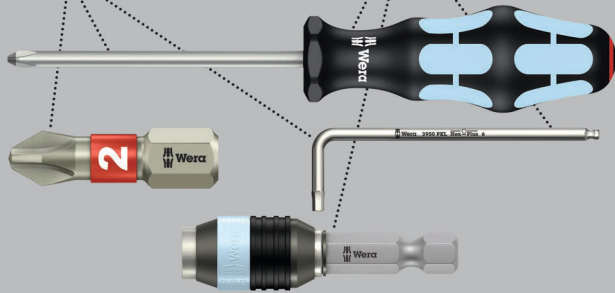

维拉不锈钢批头是由不锈钢材料制成，可有效避免锈蚀。维拉的不锈钢批头通过真空冰淬以达到所需硬度和强度，可满足工业级别应用。

3851/4 不锈钢十字螺丝批头



Code	EAN		⌀	ℓ					
	4013288		mm						
05071081001	115485	PH 1	89	3 1/2"					10
05071082001	115492	PH 2	89	3 1/2"					10
05071083001	115508	PH 3	89	3 1/2"					10

双重抗扭系统 – 给您更长的应用周期

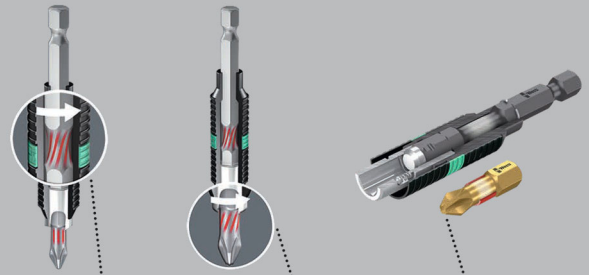

双重抗扭设计 接杆吸收一小部分扭力

大部分的扭力会被批头上标示的双重抗扭区吸收

正常使用下的扭力冲击，并不会造成不必要的磨损

851/4 BDC 十字螺丝批头

BiTorsion 批头，用于十字螺丝，尖端带细微金刚石颗粒。由此确保批头在螺丝内配合到位，减少所需的接触压力，并降低打滑风险。

带扭力区，可在峰值负荷状态下分散动能。由此极大延长了产品使用寿命；1/4"六角，适用于符合 DIN ISO 1173-F 6.3 标准的固持器。

851/4 BDC 十字螺丝批头



Code	EAN		⌀	ℓ					
	4013288		mm						
05059530001	034090	PH 1	50	2"					10
05059532001	034106	PH 2	50	2"					10
05059534001	034113	PH 3	50	2"					10

851/4 BTH 十字螺丝批头

适用于十字螺丝的 BiTorsion 双重抗扭批头, 带扭力区, 可在峰值负荷状态下分散动能。

由此极大延长了产品使用寿命; 1/4"六角, 适用于符合 DIN ISO 1173-F 6.3 标准的固持器。

851/4 BTH 十字螺丝批头



	EAN	+	⌀	ℓ				
Code	4013288		mm					
05059540001	034304	PH 1	50	2"				10
05059542001	034311	PH 2	50	2"				10
05059544001	034328	PH 3	50	2"				10

851/4 BTZ 十字螺丝批头

适用于十字螺丝的 BiTorsion 双重抗扭批头, 带扭力区, 可在峰值负荷状态下分散动能。

由此极大延长了产品使用寿命; 1/4"六角, 适用于符合 DIN ISO 1173-F 6.3 标准的固持器。

851/4 BTZ 十字螺丝批头

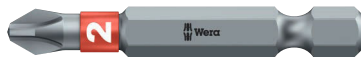

	EAN	+	⌀	ℓ				
Code	4013288		mm					
05059550001	034571	PH 1	50	2"				10
05059552001	034588	PH 2	50	2"				10
05059554001	034595	PH 3	50	2"				10

851/4 RH 小直径刀头十字螺丝批头

细杆批头能保证不伤害工作面的前提下, 进入工作面以下的螺丝孔工作。传动: 1/4"六角, 适用于DIN ISO 1173-F 6.3标准的批头接头; 设计: 小直径刀杆, 硬度更高。

851/4 RH 小直径刀头十字螺丝批头



	EAN	+	⌀	ℓ	ℓ	⌀		
Code	4013288		mm			mm		
05380161001	157065	PH 2	50	2"		4,2		10

851/4 A 十字螺丝批头

A代表航空。该批头在工作部位保留了锋利的棱角, 以便于穿透油漆涂层, 保证螺丝和批头之间有可靠的动力传输。

851/4 A 十字螺丝批头



	EAN	+	⌀	ℓ	ℓ	⌀		
Code	4013288		mm			mm		
05134929001	105165	PH 0	50	2"		3		10
05134906001	105141	PH 0	70	2 3/4"		3		10
05134907001	105172	PH 0	89	3 1/2"		3		10
05134930001	100009	PH 1	50	2"		4,5		10
05134370001	037831	PH 1	70	2 3/4"		4,5		10
05134372001	037855	PH 1	89	3 1/2"		4,5		10
05134931001	100016	PH 2	50	2"		6		10
05134371001	037848	PH 2	70	2 3/4"		6		10
05134373001	037862	PH 2	89	3 1/2"		6		10
05134910001 ¹⁾	105202	PH 2	152	6"		6		10
05134911001 ²⁾	105219	PH 2	152	6"		6		10
05134932001	100023	PH 3	50	2"		-		10
05134913001	105233	PH 3	70	2 3/4"		8		10
05134914001	105240	PH 3	89	3 1/2"		8		10
05134915001	105257	PH 3	152	6"		8		10
05160983001	106575	PH 4	50	2"		10		10

¹⁾ 驱动杆100mm长
²⁾ 驱动杆20mm长



851/4 R 小直径刀头十字螺丝批头

细杆批头能保证不伤害工作面的前提下, 进入工作面以下的螺丝孔工作。1/4"六角, 适用于DIN ISO 1173-F 6.3标准的批头接头。小直径刀杆。传动: 1/4"六角, 适用于DIN ISO 1173-F 6.3标准的批头接头。

851/4 R 小直径刀头十字螺丝批头



Code	EAN	+	1"	2"	3,0		
Code	EAN	+	mm	mm	mm		
05160899001	105547	PH 2	50	2"	3,0		10
05160896001	105554	PH 2	152	6"	3,0		10

851/4 TH 十字螺丝批头

TH抗扭批头通过杆部的较小直径, 让批头抵抗冲击的能力有显著提高, 从而避免提早崩坏的情况。

851/4 TH 十字螺丝批头



Code	EAN	+	1"	2"			
Code	EAN	+	mm	mm			
05059855001	013897	PH 1	50	2"			10
05059860001	013903	PH 2	50	2"			10
05059865001	013910	PH 3	50	2"			10

851/4 TZ 十字螺丝批头

TZ抗扭批头通过杆部的较小直径, 让批头抵抗冲击的能力有显著提高, 从而避免提早崩坏的情况。传动: 1/4"六角, 适用于DIN ISO 1173-F 6.3标准的批头接头。

851/4 TZ 十字螺丝批头



Code	EAN	+	1"	2"			
Code	EAN	+	mm	mm			
05059805001	013927	PH 1	50	2"			10
05059810001	013934	PH 2	50	2"			10
05059815001	013941	PH 3	50	2"			10

851/4 TZ 十字螺丝批头吊卡装



Code	EAN	+			
Code	EAN	+			
05134380001	4013288 037947	+	851/4 TZ PH	2x PH 1x50	3
05134381001	037954	+	851/4 TZ PH	2x PH 2x50	3
05134382001	037961	+	851/4 TZ PH	2x PH 3x50	3

851/4 Z 十字螺丝批头

维拉设计的缓冲吸收型批头能避免批头头部的早期断裂。该批头可通过产品目录中的产品字母Z来识别。1/4"六角, 适用于DIN ISO 1173-F 6.3标准的批头接头。

851/4 Z 十字螺丝批头



Code	EAN	+	1"	2"	3"		
Code	EAN	+	mm	mm	mm		
05059755001	013781	PH 1	70	2 3/4"	4,5		10
05059760001	013798	PH 1	89	3 1/2"	4,5		10
05059765001	031044	PH 1	127	5"	4,5		10
05059766001	031051	PH 1	152	6"	4,5		10
05059770001	013804	PH 2	70	2 3/4"	6,0		10
05059775001	013811	PH 2	89	3 1/2"	6,0		10
05059780001	013828	PH 2	110	4 3/8"	6,0		10
05059785001	030474	PH 2	127	5"	6,0		10
05059786001	031068	PH 2	152	6"	6,0		10
05059790001	013835	PH 3	70	2 3/4"	-		10
05059795001	013842	PH 3	89	3 1/2"	-		10
05059800001	013859	PH 3	110	4 3/8"	-		10
05059802001	031075	PH 3	152	6"	-		10

851/4 J 十字螺丝批头

J代表日本。此批头专门设计用于亚洲常用的小规格十字螺丝，这种小规格十字螺丝常见于日工业规格。

1/4"六角，适用于DIN ISO 1173-F 6.3标准的批头接头。

851/4 J 十字螺丝批头



	EAN	+	⌈	⌋	∅			
Code	4013288		mm		mm			
05135530001 ¹⁾	113252	PH 00	50	2"	2,0			10
05380200001 ¹⁾	156204	PH 00	89	3 1/2"	2,0			10
05135531001 ²⁾	113269	PH 0	50	2"	2,5			10
05380201001 ²⁾	156211	PH 0	89	3 1/2"	2,5			10
05135532001	113276	PH 1	50	2"	4,5			10
05380202001	156228	PH 1	89	3 1/2"	4,5			10

¹⁾ 专为亚洲的十字PH螺丝优化

²⁾ 尺寸根据JIS 0 (日本相机工业标准) 修改

851/4 Z 十字螺丝批头吊卡装



Code	EAN	+						
	4013288							
05073520001	105875	+	851/4 Z PH					5
			1x PH 1x89					
05136305001	213839	+	851/4 Z PH					3
			1x PH 1x152					
05073521001	105882	+	851/4 Z PH					5
			1x PH 2x89					
05136306001	213846	+	851/4 Z PH					3
			1x PH 2x152					
05073522001	105899	+	851/4 Z PH					5
			1x PH 3x89					
05136307001	213853	+	851/4 Z PH					3
			1x PH 3x152					

853/4 ACR® SL 十字螺丝批头

严选高品质怪牙批头 (防滑脱, ACR®) 减少刀头在作业中滑出螺槽的风险, 带磁性, 因此可牢固将螺丝夹持在刀头上; 热塑衬套包覆刀杆, 减少作业中伤害到工件表面的机会, 坚固耐用, 通用型, 1/4"六角, 适用于 DIN ISO 1173-F6.3规格的接口。

853/4 ACR® SL 十字螺丝批头



	EAN	+	⌈	⌋	∅			
Code	4013288		mm		mm			
05323780001	165190	PH 2	50	2"	5,2			40
05323781001	165206	PH 2	90	3 1/2"	5,2			40
05203913001	163189	PH 2	150	6"	5,2			40
05203914001	163196	PH 2	200	8"	5,2			60

853/4 ACR® 十字螺丝批头

ACR®是专门用于降低螺丝打滑的设计。批头头部的刻纹跟螺丝头槽互相咬合, 有效降低操作时打滑的可能。维拉设计的缓冲吸收型批头能避免批头头部的早期断裂。该批头可通过产品目录中的产品字母Z来识别。

1/4"六角, 适用于DIN ISO 1173-F 6.3标准的批头接头。

853/4 ACR® 十字螺丝批头



	EAN	+	⌈	⌋	∅			
Code	4013288		mm		mm			
05346286001	105578	PH 2	50	2"	5,2			10



853/4 鱼叉型十字螺丝批头 · ACR®

ACR®是专门用于降低螺丝打滑的设计。批头头部的刻纹跟螺丝头槽互相咬合,有效降低操作时打滑的可能。细杆批头。

坚固而具有韧性,用于坚硬材料。

1/4"六角,适用于DIN ISO 1173-F 6.3标准的批头接头。

853/4 鱼叉型十字螺丝批头 · ACR®



	EAN	+	□	□	∅		
Code	4013288		mm		mm		
05160901001	105592	PH 2	50	2"	3,3		10
05160895001	105608	PH 2	70	2 3/4"	3,3		10
05160908001	105615	PH 2	152	6"	3,3		10

851/2 Z 十字螺丝批头

具有韧性,通用型。

5/16"六角,适用于DIN ISO 1173-D 8批头接杆。

851/2 Z 十字螺丝批头



	EAN	+	□	□	∅		
Code	4013288		mm		mm		
05057705001	013668	PH 1	32	1 1/4"	4,5		10
05057710001	013675	PH 2	32	1 1/4"	6,0		10
05057715001	013682	PH 3	32	1 1/4"	7,6		10
05057720001	013699	PH 4	32	1 1/4"	-		10

851/11 米字螺丝批头

耐用,通用型。M4螺杆。

851/11 十字螺丝批头



	EAN	+	□	□	∅		
Code	4013288		mm		mm		
05065081001	014245	PH 2	33	1 1/4"	6,0		5

851/12 十字螺丝批头

具有韧性,通用型。M5螺杆。

851/12 十字螺丝批头

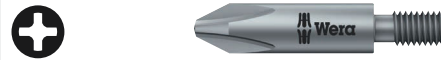

	EAN	+	□	□	∅		
Code	4013288		mm		mm		
05065110001	014252	PH 2	33	1 1/4"	7,0		5
05065112001	014269	PH 2	35	1 3/8"	7,0		5
05065114001	014276	PH 2	44,5	1 3/4"	6,0		5

851/16 十字螺丝批头

具有韧性,通用型。#10-32 UNF螺杆。

851/16 十字螺丝批头



	EAN	+	□	□	∅		
Code	4013288		mm		mm		
05065197001	014351	PH 2	44,5	1 3/4"	6,0		5

851/9 C J PH 十字螺丝批头 · 半月形

根据日本十字螺丝规格进行优化。4mm半月驱动(维拉驱动转换系列9。硬质。

851/9 C J PH 十字螺丝批头 · 半月形



	EAN	+	□	□	∅	□	□	
Code	4013288		mm		mm	mm		
05134605001 ¹⁾	190444	PH 000	44	1 47/64"	1,5	20	25/32"	10
05135270001 ¹⁾	112729	PH 00	44	1 47/64"	1,8	20	25/32"	10
05135271001 ¹⁾	112736	PH 00	64	2 33/64"	1,8	20	25/32"	10
05135272001 ²⁾	112743	PH 0	44	1 47/64"	1,8	20	25/32"	10
05135273001 ²⁾	112750	PH 0	64	2 33/64"	1,8	20	25/32"	10
05135276001 ¹⁾	112781	PH 1	44	1 47/64"	3,0	20	25/32"	10
05135277001 ¹⁾	112798	PH 1	64	2 33/64"	3,0	20	25/32"	10

¹⁾ 专为亚洲的十字PH螺丝优化

²⁾ 尺寸φ根据JCS 0 (日本相机工业标准) 修改

851/21 J 十字螺丝批头

根据日本十字螺丝规格进行优化。
4mm HIOS驱动 (维拉驱动转换系列21)。硬质。

851/21 J 十字螺丝批头



Code	EAN	+	1'	2'	Ø		
			mm		mm		
05135280001 ¹⁾	112804	PH 00	40	1 9/16"	1,8		10
05135281001 ¹⁾	112811	PH 00	60	2 3/8"	1,8		10
05135284001 ²⁾	112828	PH 0	40	1 9/16"	1,8		10
05135285001 ²⁾	112835	PH 0	60	2 3/8"	1,8		10

¹⁾ 尺寸00根据JIS 00 (日本相机工业标准) 修改

²⁾ 尺寸0根据JIS 0 (日本相机工业标准) 修改

抗冲击系统 – 为了极限需求而设计



超长使用寿命。对材料特性的有效利用, 专为满足超常规需要而开发的特殊外形, 以及特定的制造流程, 这些特点成就了维拉冲击工具的超长使用寿命。冲击批头的头部涂敷了微小的金刚石颗粒, 使产品更加有优势。这些金刚石颗粒可降低滑脱影响 (使用电动工具时出现几率尤高), 这种滑脱可能导致螺丝头滑出。金刚石颗粒能够“咬”紧螺丝头部, 这就意味着所需接触压力更小, 大大延迟了电动工具螺丝拆卸作业的疲劳开始时间。
1/4"六角, 适用于DIN ISO 1173-D 6.3标准的批头接头。

855/1 IMP DC PZ DIY Impaktor 批头



Code	EAN	+				
05057620001	178718	+	855/1 IMP DC	10x PZ 1x25		1
05057621001	157676	+	855/1 IMP DC	10x PZ 2x25		1
05057622001	157683	+	855/1 IMP DC	10x PZ 3x25		1

855/1 IMP DC 米字螺丝冲击批头吊卡装



Code	EAN	+				
05073921001	158383	+	855/1 IMP DC	1x PZ 2x25		5
05073922001	158390	+	855/1 IMP DC	1x PZ 3x25		5

Bit-Box 15 米字冲击批头批头盒



Code	EAN	+				
05057763001	187901	+	855/1 IMP DC	15x PZ 2x25		10



Kraftform 不锈钢系列 – 避免生锈

维拉的不锈钢工具通过真空冰处以达到所需硬度和强度，可满足工业级别的应用。

不锈钢材质避免外因锈蚀形成

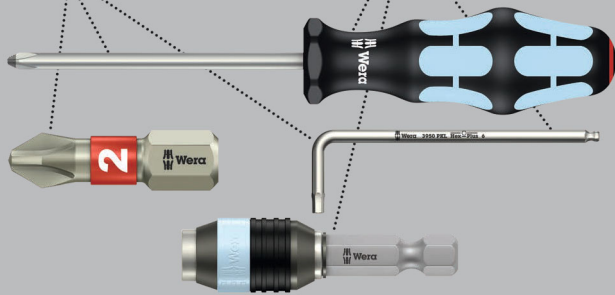

维拉不锈钢批头是由不锈钢材料制成，可有效避免锈蚀。维拉的不锈钢批头通过真空冰淬以达到所需硬度和强度，可满足工业级别应用。

1/4"六角，适用于DIN ISO 1173-D 6.3标准的批头接头。

3855/1 TS 不锈钢米字螺丝批头

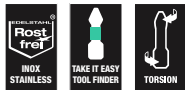

	EAN	✳	⌀	ℓ					
Code	4013288		mm						
05071020001	111012	PZ 1	25	1"					10
05071021001	111029	PZ 2	25	1"					10
05071022001	111036	PZ 3	25	1"					10

3855/1 TS SB 不锈钢批头



Code	EAN	✳							
	4013288								
05073613001	112101	✳	3855/1 TS PZ						5
			1x PZ 1x25						
05073614001	112118	✳	3855/1 TS PZ						5
			1x PZ 2x25						
05073615001	112125	✳	3855/1 TS PZ						5
			1x PZ 3x25						

双重抗扭系统 – 给您更长的应用周期

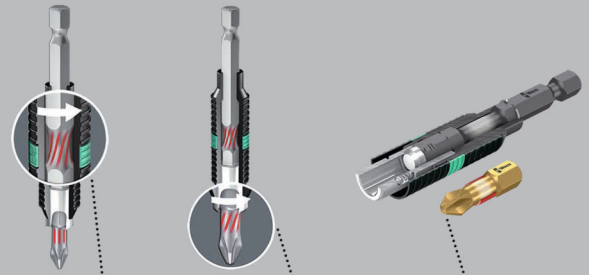

双重抗扭设计 接杆吸收一小部分扭力

大部分的扭力会被批头上标示的双重抗扭区吸收

正常使用下的扭力冲击，并不会造成不必要的磨损

855/1 BDC 米字螺丝批头

适用于用于 PZ 米字螺丝的批头，尖端带细微金刚石颗粒。由此确保批头在螺丝内配合到位，减少所需的接触压力，并降低打滑风险。

带扭力区，可在峰值负荷状态下分散动能。由此极大延长了产品使用寿命；1/4"六角，适用于符合 DIN ISO 1173-D 6.3 标准的固持器。

855/1 BDC 米字螺丝批头



	EAN	✳	⌀	ℓ					
Code	4013288		mm						
05056700001	034007	PZ 1	25	1"					10
05056702001	034014	PZ 2	25	1"					10
05056704001	034021	PZ 3	25	1"					10

855/1 BDC 米字螺丝批头吊卡装



Code	EAN		
	4013288		
05073336001	029362		855/1 BDC PZ 1x PZ 1x25
05073337001	029379		855/1 BDC PZ 1x PZ 2x25
05073338001	029386		855/1 BDC PZ 1x PZ 3x25
05073339001	029393		855/1 BDC PZ 2x PZ 2x25

855/1 BTH 米字螺丝批头

双重抗扭 批头用于 PZ 米字螺丝, 含弹性抗扭区 - 动能来自峰值负荷 - 软 双重抗扭 区防止批头在峰值负荷下扭曲。

这极大延长了产品使用寿命。与配套的接头共同实现极佳耐久性。

高硬度; 1/4"六角, 适合符合 DIN ISO 1173-D 6.3 标准的接头。

855/1 BTH 米字螺丝批头



Code	EAN							
	4013288		mm					
05056710001	034274	PZ 1	25	1"				10
05056712001	034281	PZ 2	25	1"				10
05056714001	034298	PZ 3	25	1"				10

Bit-Box 20 BTH 米字螺丝批头盒装



Code	EAN			
	4013288			
05057762001	187963		855/1 BTH PZ 20x PZ 2x25	10

855/1 BTZ 米字螺丝批头

PZ 米字*螺丝的BiTorsion批头, 具有弹性扭转区, 在峰值负载期间动能会消散。

采用较软的 BiTorsion 区域, 以防止位尖在高负载下扭转。这显著增加了产品寿命。高硬度设计。

1/4"六角, 适合符合 DIN ISO 1173-D 6.3 标准的固持器。

855/1 BTZ 米字螺丝批头



Code	EAN							
	4013288		mm					
05056720001	034489	PZ 1	25	1"				10
05056722001	034496	PZ 2	25	1"				10
05056724001	034502	PZ 3	25	1"				10

Bit-Box 20 BTZ 米字螺丝批头盒装



Code	EAN			
	4013288			
05057761001	187970		855/1 BTZ PZ 20x PZ 2x25	10



855/1 RZ 米字螺丝批头

细杆批头能保证不伤害工作面的前提下, 进入工作面以下的螺丝孔工作。

1/4"六角, 适用于DIN ISO 1173-D 6.3批头接头。

855/1 RZ 米字螺丝批头



	EAN	✳	⌀	ℓ	ℓ	⊘		
Code	4013288		mm			mm		
05135017001	175311	PZ 1	25	1"		4,2		10
05135003001	096739	PZ 2	25	1"		4,2		10

855/1 TH 米字螺丝批头

TH抗扭批头通过杆部的较小直径, 让批头抵抗冲击的能力有显著提高, 从而避免提早崩坏的情况。硬度更高。1/4"六角, 适用于DIN ISO 1173-D 6.3批头接头。

855/1 TH 米字螺丝批头



	EAN	✳	⌀	ℓ	ℓ			
Code	4013288		mm					
05056910001	014740	PZ 1	25	1"				10
05056915001	014757	PZ 2	25	1"				10
05056925001	014764	PZ 3	25	1"				10

855/1 TH 米字螺丝批头吊卡装



Code	EAN	✳						
05073370001	029638	✳	855/1 TH PZ	2x PZ 1x25				5
05073371001	029645	✳	855/1 TH PZ	2x PZ 2x25				5
05073372001	029652	✳	855/1 TH PZ	2x PZ 3x25				5
05073373001	029669	✳	855/1 TH PZ	1x PZ 1x25; 1x PZ 2x25; 1x PZ 3x25				5

855/1 TiN 米字螺丝批头

TiN代表镀钛。此批头的涂层使其适应连续生产的能力更强。

1/4"六角, 适用于DIN ISO 1173-D 6.3批头接头。

855/1 TiN 米字螺丝批头



	EAN	✳	⌀	ℓ	ℓ			
Code	4013288		mm					
0548022001	041029	PZ 2	25	1"				10

855/1 TZ 米字螺丝批头

TZ抗扭批头通过杆部的较小直径, 让批头抵抗冲击的能力有显著提高, 从而避免提早崩坏的情况。维拉设计的缓冲吸收型批头能避免批头头部的早期断裂。该批头可通过产品目录中的产品字母Z来识别。1/4"六角, 适用于DIN ISO 1173-D 6.3批头接头。

855/1 TZ 米字螺丝批头



	EAN	✳	⌀	ℓ	ℓ			
Code	4013288		mm					
05056810001	014801	PZ 1	25	1"				10
05056815001	014818	PZ 2	25	1"				10
05056825001	014825	PZ 3	25	1"				10

855/1 Z 米字螺丝批头

耐用, 通用型。1/4"六角, 适用于DIN ISO 1173-D 6.3批头接头。

855/1 Z 米字螺丝批头



	EAN	✳	⌀	ℓ	ℓ			
Code	4013288		mm					
05056805001	014535	PZ 0	25	1"				10
05072080001	014658	PZ 1	25	1"				10
05056812001	014542	PZ 1	50	2"				10
05072082001	014665	PZ 2	25	1"				10
05056820001	014559	PZ 2	50	2"				10
05072084001	014672	PZ 3	25	1"				10
05056835001	014573	PZ 4	32	1 1/4"				10

855/1 Z 米字螺丝批头吊卡装



Code	EAN		
05073308001	029096	855/1 Z PZ 2x PZ 1x25	5
05073309001	029102	855/1 Z PZ 2x PZ 2x25	5
05073310001	029119	855/1 Z PZ 2x PZ 3x25	5
05073380001	029621	855/1 Z PZ 1x PZ 4x32	5
05073311001	029126	855/1 Z PZ 1x PZ 1x25; 1x PZ 2x25; 1x PZ 3x25	5

855/1 Z DIY 米字螺丝批头



Code	EAN		
05072403001	115768	855/1 Z PZ 10x PZ 1x25	1
05072404001	115775	855/1 Z PZ 10x PZ 2x25	1
05072405001	115782	855/1 Z PZ 10x PZ 3x25	1

855/1 Z DIY 100 米字螺丝批头



Code	EAN		
05072443001	138484	855/1 Z PZ 100x PZ 1x25	1
05072444001	138491	855/1 Z PZ 100x PZ 2x25	1

Bit-Box 20 米字螺丝批头盒装



Code	EAN		
05057760001	188052	855/1 Z PZ 20x PZ 2x25	20

抗冲击系统 – 为了极限需求而设计



超长使用寿命。对材料特性的有效利用, 专为满足超常规需要而开发的特殊外形, 以及特定的制造流程, 这些特点成就了维拉冲击工具的超长使用寿命。冲击批头的头部涂敷了微小的金刚石颗粒, 使产品更加有优势。这些金刚石颗粒可降低滑脱影响(使用电动工具时出现几率尤高), 这种滑脱可能导致螺丝头滑出。金刚石颗粒能够“咬”紧螺丝头部, 这就意味着所需接触压力更小, 大大延迟了电动工具螺丝拆卸作业的疲劳开始时间。 $\frac{1}{4}$ “六角, 适用于DIN ISO 1173-F 6.3批头接头。

855/4 IMP DC PZ DIY Impaktor 批头



Code	EAN		
05057661001	157690	855/4 IMP DC 5x PZ 2x50	1
05057662001	157706	855/4 IMP DC 5x PZ 3x50	1

855/4 IMP DC 米字螺丝批头吊卡装



Code	EAN		
	4013288		
05073961001	158505	855/4 IMP DC 1x PZ 2x50	5
05073962001	158512	855/4 IMP DC 1x PZ 3x50	5

Kraftform 不锈钢系列 – 避免生锈

维拉的不锈钢工具通过真空冰处理以达到所需硬度和强度，可满足工业级别的应用。

不锈钢材质避免外因锈蚀形成

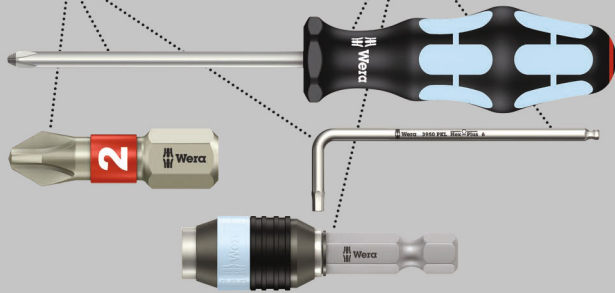

维拉不锈钢批头是由不锈钢材料制成，可有效避免锈蚀。维拉的不锈钢批头通过真空冰淬以达到所需硬度和强度，可满足工业级别应用。1/4"六角，适用于 DIN ISO 1173-F 6.3标准的批头接头。

3855/4 不锈钢米字螺丝批头



Code	EAN	★	□	□		
	4013288		mm			
05071084001	115515	PZ 1	89	3 1/2"		10
05071085001	115522	PZ 2	89	3 1/2"		10
05071086001	115539	PZ 3	89	3 1/2"		10

双重抗扭系统 – 给您更长的应用周期

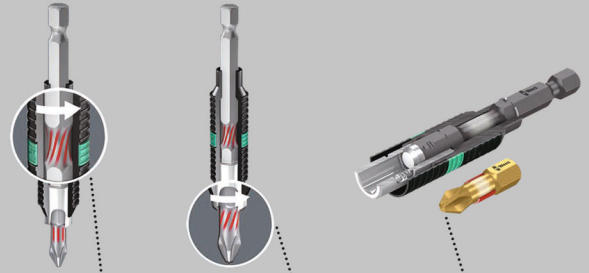

双重抗扭设计 接杆吸收一小部分扭力

大部分的扭力会被批头上标示的双重抗扭区吸收

正常使用下的扭力冲击，并不会造成不必要的磨损

855/4 BDC 米字螺丝批头

适用于用于 PZ 米字螺丝的批头，尖端带细微金刚石颗粒。由此确保批头在螺丝内配合到位，减少所需的接触压力，并降低打滑风险。

带扭力区，可在峰值负荷状态下分散动能。由此极大延长了产品使用寿命；1/4"六角，适用于符合 DIN ISO 1173-F 6.3 标准的固持器。

855/4 BDC 米字螺丝批头



Code	EAN	★	□	□		
	4013288		mm			
05059900001	034120	PZ 1	50	2"		10
05059902001	034137	PZ 2	50	2"		10
05059904001	034144	PZ 3	50	2"		10

855/4 BTH 米字螺丝批头

适用于 PZ 米字螺丝，带扭力区，可在峰值负荷状态下分散动能。

由此极大延长了产品使用寿命。与配套的固持器共同实现最佳可行的耐久特性。

超高硬度；1/4" 六角，适用于符合 DIN 标准的固持器

855/4 BTH 米字螺丝批头



Code	EAN	★	□	□		
	4013288		mm			
05059910001	034335	PZ 1	50	2"		10
05059912001	034342	PZ 2	50	2"		10
05059914001	034359	PZ 3	50	2"		10

855/4 BTZ 米字螺丝批头

双重抗扭 批头用于 PZ 米字螺丝, 含弹性抗扭区 - 动能来自峰值负荷 - 软 双重抗扭 区防止批头在峰值负荷下扭曲。

这极大延长了产品使用寿命。坚固有韧性, 通用; 1/4"六角, 适合符合 DIN ISO 1173-F 6.3 标准的接头。

855/4 BTZ 米字螺丝批头



	EAN	✳	⌀	ℓ					
Code	4013288		mm						
05059920001	034601	PZ 1	50	2"					10
05059922001	034618	PZ 2	50	2"					10
05059924001	034625	PZ 3	50	2"					10

855/4 TH 米字螺丝批头

TH抗扭批头通过杆部的较小直径, 让批头抵抗冲击的能力有显著提高, 从而避免提早崩坏的情况。硬度更高。1/4"六角, 适用于DIN ISO 1173-F 6.3批头接头。

855/4 TH 米字螺丝批头



	EAN	✳	⌀	ℓ					
Code	4013288		mm						
05060055001	015068	PZ 1	50	2"					10
05060060001	015075	PZ 2	50	2"					10
05060065001	015082	PZ 3	50	2"					10

855/4 TZ 米字螺丝批头

TZ抗扭批头通过杆部的较小直径, 让批头抵抗冲击的能力有显著提高, 从而避免提早崩坏的情况。维拉设计的缓冲吸收型批头能避免批头头部的早期断裂。该批头可通过产品目录中的产品字母Z来识别。1/4"六角, 适用于DIN ISO 1173-F 6.3批头接头。

855/4 TZ 米字螺丝批头



	EAN	✳	⌀	ℓ					
Code	4013288		mm						
05060005001	015099	PZ 1	50	2"					10
05060010001	015105	PZ 2	50	2"					10
05060015001	015112	PZ 3	50	2"					10

855/4 TZ 米字螺丝批头吊卡装

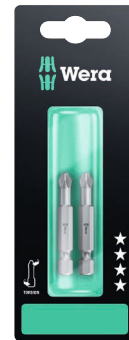

	EAN	✳							
Code	4013288								
05134384001	037985	✳	855/4 TZ PZ	2x PZ 1x50					3
05134385001	037992	✳	855/4 TZ PZ	2x PZ 2x50					3
05134386001	038005	✳	855/4 TZ PZ	2x PZ 3x50					3



855/4 Z 米字螺丝批头

耐用, 通用型。

1/4"六角, 适用于DIN ISO 1173-F 6.3批头接头。

855/4 Z 米字螺丝批头



Code	EAN						
			mm	"	mm		
05060027001	014955	PZ 1	70	2 3/4"	4,5		10
05060029001	014962	PZ 1	89	3 1/2"	4,5		10
05060031001	031426	PZ 1	127	5"	4,5		10
05060030001	031259	PZ 1	152	6"	4,5		10
05060033001	014979	PZ 2	70	2 3/4"	6,0		10
05060035001	014986	PZ 2	89	3 1/2"	6,0		10
05060037001	014993	PZ 2	110	4 3/8"	6,0		10
05060036001	031440	PZ 2	127	5"	6,0		10
05060038001	031297	PZ 2	152	6"	6,0		10
05060041001	015006	PZ 3	70	2 3/4"	-		10
05060043001	015013	PZ 3	89	3 1/2"	-		10
05060045001	015020	PZ 3	110	4 3/8"	-		10
05060047001	031433	PZ 3	152	6"	-		10

855/4 Z 米字螺丝批头吊卡装



Code	EAN			
	4013288			
05073523001	105905		855/4 Z PZ 1x PZ 1x89	5
05073524001	106452		855/4 Z PZ 1x PZ 2x89	5
05073525001	105912		855/4 Z PZ 1x PZ 3x89	5
05136308001	213860		855/4 Z PZ 1x PZ 1x152	3
05136309001	213877		855/4 Z PZ 1x PZ 2x152	3
05136310001	213884		855/4 Z PZ 1x PZ 3x152	3

855/2 Z 米字螺丝批头

耐用, 通用型。5/16"六角, 适用于DIN ISO 1173-D 8批头接头。

855/2 Z 米字螺丝批头



Code	EAN						
			mm	"	mm		
05058005001	014863	PZ 1	32	1 1/4"	4,5		10
05058010001	014870	PZ 2	32	1 1/4"	6,0		10
05058015001	014887	PZ 3	32	1 1/4"	7,6		10
05058020001	014894	PZ 4	32	1 1/4"	-		10

855/11 米字螺丝批头

耐用, 通用型。M4螺杆。

855/11 米字螺丝批头



Code	EAN						
			mm	"	mm		
05065096001	015426	PZ 2	33	1 1/4"	6,0		5

855/12 米字螺丝批头

耐用, 通用型。M5螺杆。

855/12 米字螺丝批头



Code	EAN						
			mm	"	mm		
05065129001	015457	PZ 2	44,5	1 3/4"	6,0		5

851/4 PH/S 穿心十字螺丝批头

穿心十字, 耐用, 是在钢板或金属中调整电气元件的理想工具。1/4"六角, 适用于DIN ISO 1173-F 6.3批头接头。

851/4 PH/S 穿心十字螺丝批头



Code	EAN						
			mm	"	mm		
05059720001	102577	# 1	70	2 3/4"	4,5		10
05059721001	102584	# 2	70	2 3/4"	6		10

855/4 PZ/S 穿心米字螺丝批头

穿心米字形，耐用，适用于电气元件在钢板或金属中的调整工作。1/4"六角，适用于DIN ISO 1173-F 6.3批头接头。

855/4 PZ/S 穿心米字螺丝批头



	EAN					
Code	4013288		mm	mm		
05059896001	102591	# 1	70	2 3/4"	4,5	10
05059897001	102607	# 2	70	2 3/4"	6	10

抗冲击系统 – 为了极限需求而设计



超长使用寿命。对材料特性的有效利用，专为满足超常规需要而开发的特殊外形，以及特定的制造流程，这些特点成就了维拉冲击工具的超长使用寿命。冲击批头的头部涂敷了微小的金刚石颗粒，使产品更加有优势。这些金刚石颗粒可降低滑脱影响（使用电动工具时出现几率尤高），这种滑脱可能导致螺丝头滑出。金刚石颗粒能够“咬”紧螺丝头部，这就意味着所需接触压力更小，大大延迟了电动工具螺丝拆卸作业的疲劳开始时间。1/4"六角，适用于DIN ISO 1173-D 6.3批头接头。

867/1 IMP DC TORX®梅花 DIY Impaktor 批头

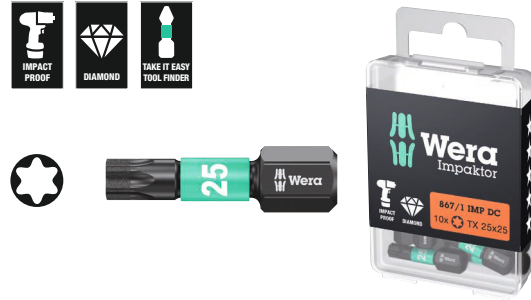

Code	EAN			
	4013288			
05057628001	178688		867/1 IMP DC 10x TX 10x25	1
05057623001	169242		867/1 IMP DC 10x TX 15x25	1
05057624001	163165		867/1 IMP DC 10x TX 20x25	1
05057625001	157447		867/1 IMP DC 10x TX 25x25	1
05057626001	157454		867/1 IMP DC 10x TX 30x25	1
05057627001	157461		867/1 IMP DC 10x TX 40x25	1

867/1 IMP DC 梅花螺丝冲击批头吊卡装



Code	EAN			
	4013288			
05073924001	163240		867/1 IMP DC 1x TX 20x25	5
05073925001	158406		867/1 IMP DC 1x TX 25x25	5
05073926001	158413		867/1 IMP DC 1x TX 30x25	5
05073927001	158420		867/1 IMP DC 1x TX 40x25	5

Bit-Box 15 Impaktor TX 梅花冲击批头盒装



Code	EAN			
	4013288			
05057772001	187871		867/1 IMP DC 15x TX 20x25	10
05057775001	187888		867/1 IMP DC 15x TX 25x25	10
05057776001	187895		867/1 IMP DC 15x TX 30x25	10



Kraftform 不锈钢系列 – 避免生锈

维拉的不锈钢工具通过真空冰淬以达到所需硬度和强度，可满足工业级别的应用。

不锈钢材质避免外因锈蚀形成

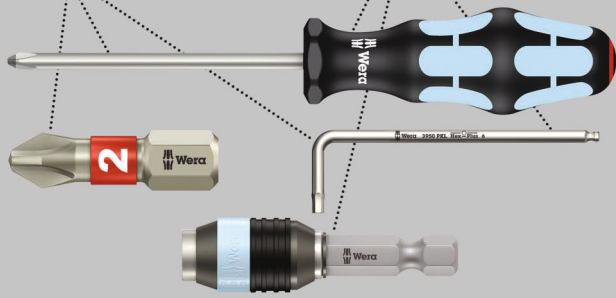

维拉不锈钢批头是由不锈钢材料制成，可有效避免锈蚀。维拉的不锈钢批头通过真空冰淬以达到所需硬度和强度，可满足工业级别应用。生锈问题的解决方案：使用不锈钢工具拆装不锈钢螺丝。维拉不锈钢工具是由不锈钢材料制成，可有效避免难看的锈蚀。抗扭批头通过缩小中间杆部的直径，让批头抵抗冲击的能力有显著提高，从而避免提早失效的情况。

1/4"六角，适用于DIN ISO 1173-D 6.3批头接头。

3867/1 TS TORX® 不锈钢梅花螺丝批头吊卡装



Code	EAN		六角	长度	长度				
	4013288		mm						
05071030001	111043	TX 8	25	1"					10
05071032001	111067	TX 10	25	1"					10
05071033001	111074	TX 15	25	1"					10
05071034001	111081	TX 20	25	1"					10
05071035001	111098	TX 25	25	1"					10
05071037001	111111	TX 30	25	1"					10
05071038001	111128	TX 40	25	1"					10

3867/1 TS TORX® 不锈钢梅花螺丝批头吊卡装



Code	EAN			
	4013288			
05073620001	117670		3867/1 TS TORX® 1x TX 10x25	5
05073621001	117687		3867/1 TS TORX® 1x TX 15x25	5
05073622001	117694		3867/1 TS TORX® 1x TX 20x25	5
05073623001	117700		3867/1 TS TORX® 1x TX 25x25	5
05073625001	117724		3867/1 TS TORX® 1x TX 30x25	5

双重抗扭系统 – 给您更长的应用周期

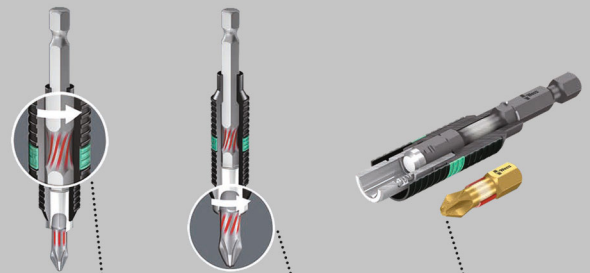

双重抗扭设计 接杆吸收一小部分扭力

大部分的扭力会被批头上标示的双重抗扭区吸收

正常使用下的扭力冲击，并不会造成不必要的磨损

867/1 BDC TORX® 梅花螺丝批头

批头用于TORX® 梅花螺丝，批头上含细微金刚石颗粒。由此确保批头在螺丝内配合到位，减少所需的接触压力，并降低打滑风险。

带扭力区，可在峰值负荷状态下分散动能。由此极大延长了产品使用寿命。

1/4"六角，适用于符合 DIN ISO 1173-D 6.3 标准的固持器。

867/1 BDC TORX® 梅花螺丝批头



	EAN								
Code	4013288		mm						
05066100001	034038	TX 10	25	1"					10
05066102001	034045	TX 15	25	1"					10
05066104001	034052	TX 20	25	1"					10
05066106001	034069	TX 25	25	1"					10
05066108001	034076	TX 30	25	1"					10
05066110001	034083	TX 40	25	1"					10

867/1 BDC TORX® 梅花螺丝批头吊卡装

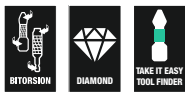

	EAN								
Code	4013288								
05134374001	099778		867/1 TORX® BDC	1x TX 10x25					5
05134375001	099785		867/1 TORX® BDC	1x TX 15x25					5
05134376001	099792		867/1 TORX® BDC	1x TX 20x25					5
05134377001	099808		867/1 TORX® BDC	1x TX 25x25					5
05134378001	099822		867/1 TORX® BDC	1x TX 30x25					5
05134379001	099815		867/1 TORX® BDC	1x TX 40x25					5

867/1 BTZ TORX® 梅花螺丝批头

适用于 TORX® 内六角螺丝的 BiTorsion 双重抗扭批头，具有扭力区，可在峰值负荷状态下分散动能。由此显著提升了产品使用寿命。

实现最佳使用寿命，带配套固持器。坚固，适合通用型应用。

1/4"六角，适用于符合 DIN ISO 1173-D 6.3 的固持器。

867/1 BTZ TORX® 梅花螺丝批头



	EAN								
Code	4013288		mm						
05066120001	034519	TX 10	25	1"					10
05066122001	034526	TX 15	25	1"					10
05066124001	034533	TX 20	25	1"					10
05066126001	034540	TX 25	25	1"					10
05066128001	034557	TX 30	25	1"					10
05066130001	034564	TX 40	25	1"					10

867/1 TORX® HF 带固持功能的批头

- 用于 TORX® 套筒螺丝
- TORX® 梅花螺丝固持功能
- 另外，还适用于 Würth ASSY 螺丝以及 Altenloh SPAX T-STAR plus 螺丝
- 1/4"六角驱动 (维拉驱动转换系列1)
- 带“易寻”色标系统，可轻松找到所需套筒

867/1 TORX® HF 带固持功能的批头



	EAN								
Code	4013288		mm						
05066140001	226334	TX 10	25	1"					10
05066141001	226341	TX 15	25	1"					10
05066142001	226365	TX 20	25	1"					10
05066143001	226358	TX 25	25	1"					10
05066144001	226389	TX 30	25	1"					10
05066145001 ¹⁾	226655	TX 40	25	1"					10

¹⁾ Pound-thru 六角；无Take it easy易寻色标系统。



批头袋 20 TX HF



Code	EAN			
	4013288			
05057777001	226013		867/1 TORX® HF 20x TX 20x25	20
05057778001	226020		867/1 TORX® HF 20x TX 25x25	20

867/1 TZ TORX® 梅花螺丝批头

TZ抗扭批头通过杆部的较小直径, 让批头抵抗冲击的能力有显著提高, 从而避免提早崩坏的情况。维拉设计的缓冲吸收型批头能避免批头头部的早期断裂。该批头可通过产品目录中的产品字母Z来识别。1/4"六角, 适用于 DIN ISO 1173-D 6.3批头接头。

867/1 TZ TORX® 梅花螺丝批头



Code	EAN		mm	mm	mm		
05066300001	015709		25	1"	4,2		10
05066301001	015716		25	1"	4,2		10
05066302001	015723		25	1"	4,2		10
05066303001	015730		25	1"	4,2		10
05066304001	015747		25	1"	4,2		10
05066305001	015754		25	1"	4,2		10
05066308001	015761		25	1"	4,2		10
05066310001	015778		25	1"	4,8		10
05066312001	015785		25	1"	5,5		10
05066313001	015792		25	1"	5,5		10
05066315001	015808		25	1"	6,0		10
05066320001	015815		25	1"	-		10

867/1 TORX® 梅花螺丝批头



Code	EAN		mm	mm	mm		
05135140001	107114		25	1"	1,5		10
05135141001	107121		25	1"	1,5		10
05135142001	111456		25	1"	2,0		10
05135143001	111463		25	1"	2,0		10
05066492001	030405		25	1"	3,0		10
05066493001	030412		25	1"	3,0		10
05066494001	030429		25	1"	3,0		10
05066495001	030436		25	1"	3,0		10
05066496001	030443		25	1"	3,0		10
05066485001	030320		25	1"	4,0		10
05066486001	030337		25	1"	4,0		10
05066487001	030344		25	1"	5,0		10
05066488001	030351		25	1"	5,0		10
05066489001	030368		25	1"	6,0		10
05066490001	030375		25	1"	6,0		10
05066491001	030382		25	1"	-		10
05066325001	031174		35	1 3/8"	8,0		10
05066330001	031181		35	1 3/8"	9,0		10
05066335001	031167		35	1 3/8"	12,0		10

867/1 TORX® 梅花螺丝批头吊卡装



Code	EAN			
	4013288			
05073313001	029140		867/1 TORX® 2x TX 10x25	5
05073340001	029591		867/1 TORX® 2x TX 15x25	5
05073314001	029157		867/1 TORX® 2x TX 20x25	5
05073315001	029164		867/1 TORX® 2x TX 25x25	5
05073316001	029171		867/1 TORX® 2x TX 30x25	5
05073317001	029188		867/1 TORX® 2x TX 40x25	5
05073346001	125859		867/1 TORX® 1x TX 50x35	5
05073375001	037503		867/1 TORX® 1x TX 10x25 1x TX 15x25 1x TX 20x25	5
05073376001	037510		867/1 TORX® 1x TX 25x25; 1x TX 30x25; 1x TX 40x25	5

867/1 TORX® DIY 梅花螺丝批头吊盒装



Code	EAN			
	4013288			
05072406001	115799		867/1 TORX® 10x TX 10x25	1
05072407001	115805		867/1 TORX® 10x TX 15x25	1
05072408001	115812		867/1 TORX® 10x TX 20x25	1
05072409001	115829		867/1 TORX® 10x TX 25x25	1
05072411001	115843		867/1 TORX® 10x TX 30x25	1
05072412001	115850		867/1 TORX® 10x TX 40x25	1

867/1 TORX® DIY 100 梅花螺丝批头吊桶装



Code	EAN			
	4013288			
05072446001	138507		867/1 TORX® 100x TX 10x25	1
05072447001	138514		867/1 TORX® 100x TX 15x25	1
05072448001	138521		867/1 TORX® 100x TX 20x25	1
05072449001	138538		867/1 TORX® 100x TX 25x25	1
05072451001	138552		867/1 TORX® 100x TX 30x25	1
05072452001	138569		867/1 TORX® 100x TX 40x25	1

Bit-Box 20 TX 梅花螺丝批头盒装



Code	EAN			
	4013288			
05057770001	187994		867/1 TORX® 20x TX 20x25	20
05057773001	188007		867/1 TORX® 20x TX 25x25	20

867/1 Z TORX® W 梅花螺丝批头

锥形梅花头可以更好地与螺丝头贴合。

再配合更大的驱动深度, TORX® Wedge外形能给梅花螺丝传递更多的扭力。1/4"六角, 适用于DIN ISO 1173-D 6.3批头接头。

867/1 Z TORX® W 梅花螺丝批头



Code	EAN								
	4013288								
05066455001	016034		TX 15	25	1"				10
05066460001	016041		TX 20	25	1"				10
05066465001	016058		TX 25	25	1"				10



867/1 ZA TORX® 梅花螺丝批头

TORX® ZA螺丝在螺丝孔底部有凹陷的定位孔，带有定位销的TORX® ZA批头可以与之完美配合。耐用，通用型。

1/4"六角，适用于DIN ISO 1173-D 6.3批头接头。

867/1 ZA TORX® 梅花螺丝批头



Code	EAN					
Code	EAN		mm	"	mm	
05066081001	107190	TX 15	25	1"	4,0	10
05066082001	107206	TX 20	25	1"	5,0	10
05066083001	107213	TX 25	25	1"	5,0	10

抗冲击系统 – 为了极限需求而设计



超长使用寿命。对材料特性的有效利用，专为满足超常规需要而开发的特殊外形，以及特定的制造流程，这些特点成就了维拉冲击工具的超长使用寿命。冲击批头的头部涂敷了微小的金刚石颗粒，使产品更加有优势。这些金刚石颗粒可降低滑脱影响（使用电动工具时出现几率尤高），这种滑脱可能导致螺丝头滑出。金刚石颗粒能够“咬”紧螺丝头部，这就意味着所需接触压力更小，大大延迟了电动工具螺丝拆卸作业的疲劳开始时间。
1/4"六角，适用于DIN ISO 1173-F 6.3批头接头。

867/4 IMP DC TORX®梅花 DIY Impaktor 批头



Code	EAN			
Code	EAN			
05057664001	163172		867/4 IMP DC 5x TX 20x50	1
05057665001	157515		867/4 IMP DC 5x TX 25x50	1
05057666001	157522		867/4 IMP DC 5x TX 30x50	1
05057667001	157539		867/4 IMP DC 5x TX 40x50	1

867/4 IMP DC 梅花螺丝冲击批头吊卡装

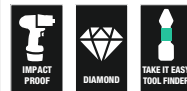

Code	EAN			
Code	EAN			
05073964001	163257		867/4 IMP DC 1x TX 20x50	5
05073965001	158529		867/4 IMP DC 1x TX 25x50	5
05073966001	158536		867/4 IMP DC 1x TX 30x50	5
05073967001	158543		867/4 IMP DC 1x TX 40x50	5

梅花齿廓固持工具系列

卡紧梅花型螺丝的楔入力



在引擎等狭小场所拆装工件时，不可能确保手拿着螺丝刀同时牢牢抓住螺丝，因此螺丝经常会掉下去，需要花大量时间去寻找，否则甚至可能引发危险。

维拉开发的HF工具能够有效解决这一问题，它对原有的TORX®梅花形状进行了优化，来自于驱动头和螺丝外形之间的表面压力形成了楔入力，从而使螺丝能牢固夹着在螺丝刀上。1/4"六角，适用于DIN ISO 1173-F 6.3批头接头。

867/4 TORX® HF 带固持功能的批头

- 用于 TORX® 套筒螺丝
- TORX® 梅花螺丝固持功能
- 另外，还适用于 Würth ASSY 螺丝以及 Altenloh SPAX T-STAR plus 螺丝
- 1/4"六角驱动 (维拉驱动转换系列4)
- 带“易寻”色标系统，可轻松找到所需套筒

867/4 TORX® HF 带固持功能的批头



	EAN						
Code	4013288		mm	mm	mm		
05060505001	226747	TX 8	50	2"	3,0		10
05060506001	226754	TX 10	50	2"	4,0		10
05060507001	226761	TX 15	50	2"	4,0		10
05060508001	226778	TX 20	50	2"	4,5		10
05060509001	226785	TX 25	50	2"	6,0		10
05060510001	226792	TX 30	50	2"	6,0		10
05060511001 ¹⁾	226808	TX 40	50	2"	-		10

¹⁾ Pound-thru 六角；无Take it easy易寻色标系统。

867/4 KK TORX® 梅花螺丝批头

球头：球头驱动意味着轴身可以绕着螺丝旋转，因此可以在狭窄区域利用角度进行螺丝拆装。坚固有韧性强，通用。1/4"六角，适合符合 DIN ISO 1173-F 6.3 标准的接头。

- 1/4"六角驱动 (维拉驱动转换系列4)

867/4 KK TORX® 梅花螺丝批头



	EAN						
Code	4013288		mm	mm	mm		
05059700001	155979	TX 10	89	3 1/2"			5
05059701001	155986	TX 15	89	3 1/2"			5
05059702001	155993	TX 20	89	3 1/2"			5
05059703001	156006	TX 25	89	3 1/2"			5
05059704001	156013	TX 30	89	3 1/2"			5
05059705001	156020	TX 40	89	3 1/2"			5



867/4 Z TORX® 梅花螺丝批头

优质批头, 用于 TORX® 套筒螺丝。坚固, 通用。
1/4"六角, 适合符合 DIN ISO 1173-F 6.3 标准的固持器。

867/4 Z TORX® 梅花螺丝批头



Code	EAN						
Code	4013288		mm		mm		
05135200001	107138	TX 1	50	2"	2,0		10
05135201001	107145	TX 2	50	2"	2,0		10
05135202001	112620	TX 3	50	2"	2,0		10
05135204001	041333	TX 4	50	2"	3,0		10
05135205001	031808	TX 5	50	2"	3,0		10
05308428001	041340	TX 6	50	2"	3,0		10
05134740001	035905	TX 6	70	2 3/4"	3,0		10
05332600001	033895	TX 6	89	3 1/2"	3,0		10
05328448001	038432	TX 6	152	6"	3,0		10
05160830001	113283	TX 7	50	2"	3,0		10
05345047001	128423	TX 7	70	2 3/4"	3,0		10
05060131001	030498	TX 8	50	2"	3,0		10
05060098001	030504	TX 8	70	2 3/4"	3,0		10
05060185001	030511	TX 8	89	3 1/2"	3,0		10
05060195001	030528	TX 8	152	6"	3,0		10
05319835001	128430	TX 9	70	2 3/4"	3,0		10
05060193001	155566	TX 9	89	3 1/2"	3,0		10
05060194001	156945	TX 9	152	6"	3,0		10
05060132001	030535	TX 10	50	2"	4,0		10
05060100001	016171	TX 10	70	2 3/4"	4,0		10
05060186001	030481	TX 10	89	3 1/2"	4,0		10
05060196001	030542	TX 10	152	6"	4,0		10
05060133001	030559	TX 15	50	2"	4,0		10
05060105001	016188	TX 15	70	2 3/4"	4,0		10
05060187001	030566	TX 15	89	3 1/2"	4,0		10
05060197001	030573	TX 15	152	6"	4,0		10
05060134001	030580	TX 20	50	2"	4,5		10
05060110001	016195	TX 20	70	2 3/4"	4,5		10
05060188001	030597	TX 20	89	3 1/2"	4,5		10
05060198001	030603	TX 20	152	6"	4,5		10
05060135001	030610	TX 25	50	2"	6,0		10
05060115001	016201	TX 25	70	2 3/4"	6,0		10
05060189001	030627	TX 25	89	3 1/2"	6,0		10
05060199001	030634	TX 25	152	6"	6,0		10
05060136001	030641	TX 27	50	2"	6,0		10
05060120001	016218	TX 27	70	2 3/4"	6,0		10
05060190001	030658	TX 27	89	3 1/2"	6,0		10
05060200001	030665	TX 27	152	6"	6,0		10
05060137001	030672	TX 30	50	2"	6,0		10
05060125001	016225	TX 30	70	2 3/4"	6,0		10
05060191001	030689	TX 30	89	3 1/2"	6,0		10
05060201001	030696	TX 30	152	6"	6,0		10
05060138001	030702	TX 40	50	2"	-		10
05060130001	016232	TX 40	70	2 3/4"	-		10
05060192001	030719	TX 40	89	3 1/2"	-		10
05060202001	030726	TX 40	152	6"	-		10

867/4 Z TORX® SB 梅花批头



Code	EAN			
Code	4013288			
05073720001	132789		867/4 Z TORX® 2x TX 10x50	3
05073526001	105929		867/4 Z TORX® 1x TX 10x89	5
05073470001	226273		867/4 Z TORX® 3x TX 10x89	1
05136311001	213891		867/4 Z TORX® 1x TX 10x152	3
05073721001	132796		867/4 Z TORX® 2x TX 15x50	3
05073527001	105936		867/4 Z TORX® 1x TX 15x89	5
05073471001	226228		867/4 Z TORX® 3x TX 15x89	1
05136312001	213907		867/4 Z TORX® 1x TX 15x152	3
05073722001	132802		867/4 Z TORX® 2x TX 20x50	3
05073528001	105943		867/4 Z TORX® 1x TX 20x89	5
05073472001	226235		867/4 Z TORX® 3x TX 20x89	1
05136313001	213914		867/4 Z TORX® 1x TX 20x152	3
05073723001	132826		867/4 Z TORX® 2x TX 25x50	3
05073529001	105950		867/4 Z TORX® 1x TX 25x89	5
05073473001	226242		867/4 Z TORX® 3x TX 25x89	1
05136314001	213921		867/4 Z TORX® 1x TX 25x152	3
05073724001	132833		867/4 Z TORX® 2x TX 30x50	3
05073530001	105967		867/4 Z TORX® 1x TX 30x89	5
05073474001	226259		867/4 Z TORX® 3x TX 30x89	1
05136315001	213938		867/4 Z TORX® 1x TX 30x152	3
05073531001	105974		867/4 Z TORX® 1x TX 40x89	5
05136316001	213945		867/4 Z TORX® 1x TX 40x152	3

867/2 Z TORX® 梅花螺丝批头

具有韧性, 通用型。5/16"六角, 适用于DIN ISO 1173-D 8 批头接杆。

867/2 Z TORX® 梅花螺丝批头



	EAN						
Code	4013288		mm	mm	mm		
05066901001	016096	TX 20	35	1 3/8"	4,5		10
05066900001	016102	TX 25	35	1 3/8"	5,8		10
05066902001	016119	TX 27	35	1 3/8"	5,8		10
05066905001	016126	TX 30	35	1 3/8"	6,0		10
05066910001	016133	TX 40	35	1 3/8"	7,0		10
05066915001	016140	TX 45	35	1 3/8"	-		10
05066920001	016157	TX 50	35	1 3/8"	-		10
05066941001	104007	TX 50	50	2"	-		10
05066950001	104526	TX 50	70	2 3/4"	-		10
05066925001	016164	TX 55	35	1 3/8"	12,0		10

867/12 TORX® 梅花螺丝批头

具有韧性, 通用型。M5螺杆。

867/12 TORX® 梅花螺丝批头



	EAN						
Code	4013288		mm	mm	mm		
05064155001	026484	TX 20	45	1 3/4"	6,0		10

867/15 TORX® 梅花螺丝批头

具有韧性, 通用型。M6螺杆。

867/15 TORX® 梅花螺丝批头



	EAN						
Code	4013288		mm	mm	mm		
05064170001	032607	TX 20	45	1 3/4"	8,0		10
05064175001	032980	TX 25	45	1 3/4"	8,0		10

867/9 C TORX® 梅花螺丝批头 · 半月形

硬度更高。4mm半月驱动 (维拉驱动转换系列9。硬质。

867/9 C TORX® 梅花螺丝批头 · 半月形



	EAN						
Code	4013288		mm	mm	mm		
05135220001	112637	TX 1	44	1 47/64"	1,5		10
05135221001	112644	TX 2	44	1 47/64"	1,5		10
05135222001	112651	TX 3	44	1 47/64"	1,7		10
05345352001	113597	TX 4	44	1 47/64"	1,8		10
05345018001	113504	TX 4	64	2 33/64"	2,0		10
05200496001	214881	TX 5	44	1 47/64"	1,6		10
05345351001	113580	TX 5	44	1 47/64"	3,0		10
05345032001	113542	TX 5	64	2 33/64"	2,0		10
05345350001	113573	TX 6	44	1 47/64"	3,0		10
05345056001	113566	TX 6	64	2 33/64"	2,0		10
05332610001	035868	TX 6	70	2 3/4"	3,0		10
05345035001	113559	TX 7	64	2 33/64"	2,3		10
05345026001	113528	TX 8	44	1 47/64"	3,0		10
05345028001	113535	TX 8	64	2 33/64"	3,0		10
05332609001	035714	TX 8	70	2 3/4"	3,0		10
05332607001	037107	TX 10	70	2 3/4"	3,0		10

867/1 Z TORX® B0 防盗梅花螺丝批头

带安全销的TORX®工具可防止安全螺丝被随意拆卸。这些防盗螺丝头有伸出到齿廓的安全销, 普通的TORX®工具无法使用, 而TORX® B0工具的孔可与其相匹配, 从而拆卸安全螺丝。1/4"六角, 适用于DIN ISO 1173-D 6.3批头接头。

867/1 Z TORX® B0 防盗梅花螺丝批头



	EAN					
Code	4013288		mm	mm		
05066497001	015822	TX 7	25	1"		10
05066498001	015839	TX 8	25	1"		10
05066499001	015846	TX 9	25	1"		10
05066500001	015853	TX 10	25	1"		10
05066505001	015860	TX 15	25	1"		10
05066510001	015877	TX 20	25	1"		10
05066515001	015884	TX 25	25	1"		10
05066520001	015891	TX 27	25	1"		10
05066525001	015907	TX 30	25	1"		10
05066530001	015914	TX 40	25	1"		10



867/1 Z TORX® BO SB 批头 · 防盗型



Code	EAN			
	4013288			
05073064001	202666		867/1 Z TORX® BO 2x TX 20x25	5
05073065001	202673		867/1 Z TORX® BO 2x TX 25x25	5
05073066001	202680		867/1 Z TORX® BO 2x TX 30x25	5

3867/4 TORX® BO 不锈钢防盗梅花螺丝批头

维拉不锈钢批头是由不锈钢材料制成, 可有效避免锈蚀。维拉的不锈钢批头通过真空冰淬以达到所需硬度和强度, 可满足工业级别应用。

1/4"六角, 适用于DIN ISO 1173-F 6.3批头接头。

3867/4 TORX® BO 不锈钢防盗梅花螺丝批头



Code	EAN						
	4013288		mm		mm		
05071089001	115546	TX 10	89	3 1/2"	4,0		10
05071090001	115553	TX 15	89	3 1/2"	4,0		10
05071091001	115560	TX 20	89	3 1/2"	4,5		10
05071092001	115577	TX 25	89	3 1/2"	5,5		10
05071094001	115584	TX 30	89	3 1/2"	6,0		10

867/4 Z TORX® BO 防盗梅花螺丝批头

耐用, 通用型。1/4"六角, 适用于DIN ISO 1173-F 6.3批头接头。

867/4 Z TORX® BO 防盗梅花螺丝批头



Code	EAN						
	4013288		mm		mm		
05060139001	030733	TX 8	70	2 3/4"	3,0		10
05060048001	094513	TX 8	89	3 1/2"	3,0		10
05060049001	094520	TX 9	89	3 1/2"	3,0		10
05060140001	026897	TX 10	70	2 3/4"	4,0		10
05060050001	094537	TX 10	89	3 1/2"	4,0		5
05060141001	030740	TX 15	70	2 3/4"	4,0		10
05060051001	094544	TX 15	89	3 1/2"	4,0		5
05060142001	026903	TX 20	70	2 3/4"	4,5		10
05060052001	094551	TX 20	89	3 1/2"	4,5		5
05060143001	026910	TX 25	70	2 3/4"	6,0		10
05060053001	094568	TX 25	89	3 1/2"	6,0		10
05060144001	026927	TX 27	70	2 3/4"	6,0		10
05060057001	094643	TX 27	89	3 1/2"	6,0		5
05060145001	026934	TX 30	70	2 3/4"	6,0		10
05060054001	094575	TX 30	89	3 1/2"	6,0		5
05060146001	026941	TX 40	70	2 3/4"	-		10
05060056001	094582	TX 40	89	3 1/2"	-		5

867/4 Z TORX® BO SB 批头 · 防盗型



Code	EAN			
	4013288			
05073070001	202604		867/4 Z TORX® BO 2x TX 20x70	5
05073071001	202611		867/4 Z TORX® BO 2x TX 25x70	5
05073072001	202628		867/4 Z TORX® BO 2x TX 30x70	5
05073073001	202574		867/4 Z TORX® BO 2x TX 40x70	5

867/1 Z IP TORX PLUS® 增强型梅花螺丝批头

与常规的圆形TORX®齿廓相比, TORX PLUS®工具的椭圆形齿廓扩大了工具和螺丝之间传递扭矩的6个侧面, 因此拆装螺丝时的外力分布在一个较大的表面积上, 可传递更高的扭矩, 并且延长了螺丝和工具的使用寿命。切割工具中的“中心锁定螺丝”代表了这种螺丝外形的典型应用。硬质合金刀片顶端夹具的热影响经常“烘烤”固定螺丝, 需要有一个形状来大幅增强拧螺丝时的扭矩。为此, 扭矩稳定的螺钉外形可避免螺丝可能产生的伤害、减少昂贵的停机时间。耐用。1/4"六角, 适用于DIN ISO 1173-D 6.3批头接头。

867/1 Z IP TORX PLUS® 增强型梅花螺丝批头



Code	EAN		mm					
	4013288							
05135120001	112606	1 IP	25	1"				10
05135121001	112613	2 IP	25	1"				10
05160956001	113313	3 IP	25	1"				10
05134695001	103109	4 IP	25	1"				10
05066272001	035684	5 IP	25	1"				10
05066274001	031556	6 IP	25	1"				10
05066276001	031563	7 IP	25	1"				10
05066278001	031570	8 IP	25	1"				10
05066279001	033635	9 IP	25	1"				10
05066280001	031549	10 IP	25	1"				10
05066282001	031587	15 IP	25	1"				10
05066284001	031594	20 IP	25	1"				10
05066286001	031600	25 IP	25	1"				10
05066287001	031617	27 IP	25	1"				10
05066288001	031624	30 IP	25	1"				10
05066290001	031631	40 IP	25	1"				10

867/4 IP TORX PLUS® 增强型梅花螺丝批头



Code	EAN		mm	mm	mm			
	4013288							
05134664001	112514	1 IP	50	2"	2,0			10
05134665001	112521	2 IP	50	2"	2,0			10
05134668001	106568	3 IP	50	2"	2,0			10
05134691001	103093	4 IP	50	2"	3,0			10
05134678001	098030	5 IP	50	2"	3,0			10
05134680001	037220	6 IP	50	2"	3,0			10
05134667001	095596	6 IP	89	3 1/2"	3,0			10
05134690001	095602	6 IP	152	6"	3,0			10
05134681001	037237	7 IP	50	2"	3,0			10
05134679001	037190	8 IP	50	2"	3,0			10
05134670001	032812	8 IP	89	3 1/2"	3,0			10
05134682001	037244	8 IP	152	6"	3,0			10
05160917001	038951	9 IP	50	2"	3,0			10
05134669001	033871	9 IP	89	3 1/2"	3,0			10
05134683001	037251	10 IP	50	2"	4,0			10
05134684001	037268	10 IP	70	2 3/4"	4,0			10
05134671001	032829	10 IP	89	3 1/2"	4,0			10
05134685001	037275	15 IP	50	2"	4,0			10
05134686001	037282	15 IP	70	2 3/4"	4,0			10
05134672001	032836	15 IP	89	3 1/2"	4,0			10
05134687001	037299	20 IP	50	2"	4,5			10
05134688001	037305	20 IP	70	2 3/4"	4,5			10
05134673001	032843	20 IP	89	3 1/2"	4,5			10
05134609001	224767	25 IP	50	2"	6,0			10
05134674001	032850	25 IP	89	3 1/2"	6,0			10
05134675001	032867	27 IP	89	3 1/2"	6,0			10
05320430001	113382	30 IP	50	2"	6,0			10
05134676001	032874	30 IP	89	3 1/2"	6,0			10
05134677001	032881	40 IP	89	3 1/2"	-			10

867/9 C IP TORX PLUS® 增强型梅花螺丝批头 · 半月形

硬度更高。4mm半月驱动 (维拉驱动转换系列9。硬质。

867/9 C IP TORX PLUS® 增强型梅花螺丝批头 · 半月形



Code	EAN		mm	mm	mm	mm	mm	
	4013288							
05135230001	112668	1 IP	44	1 47/64"	1,5	20	25/32"	10
05135231001	112675	2 IP	44	1 47/64"	1,5	20	25/32"	10
05135232001	112682	3 IP	44	1 47/64"	1,7	20	25/32"	10
05326310001	113399	4 IP	44	1 47/64"	2,0	20	25/32"	10
05345019001	113511	4 IP	64	2 33/64"	2,0	20	25/32"	10
05135233001	112699	5 IP	44	1 47/64"	2,0	20	25/32"	10
05344900001	113498	6 IP	44	1 47/64"	2,25	20	25/32"	10
05135234001	112705	8 IP	44	1 47/64"	3,0	20	25/32"	10
05332606001	037091	8 IP	70	2 3/4"	3,0	20	25/32"	10
05135235001	112712	10 IP	44	1 47/64"	3,0	20	25/32"	10



IPR TORX PLUS®

这是一种设有钻孔的5棱TORX PLUS®型面。

相比常见的六个侧面和一个钻孔，这种驱动几何结构只设有五个侧面来防止安全螺丝未经许可被拆卸，它不能被传统的、常见的工具拧开。

867/1 IPR TORX PLUS® 防盗增强型梅花螺丝批头



	EAN		⌀	ℓ	ℓ ₁			
Code	4013288		mm	mm	mm			
05134699001	034878	8 IPR	25	1"				10
05134698001	037817	9 IPR	25	1"				10
05134700001	034823	10 IPR	25	1"				10
05134701001	034724	15 IPR	25	1"				10
05134702001	034731	20 IPR	25	1"				10
05134703001	034748	25 IPR	25	1"				10
05134704001	034847	27 IPR	25	1"				10
05134705001	034830	30 IPR	25	1"				10
05134706001	034854	40 IPR	35	1 3/8"				10
05134707001	034861	45 IPR	35	1 3/8"				10

867/4 IPR TORX PLUS® 防盗增强型梅花螺丝批头

优质批头，用于 TORX PLUS® 增强型梅花螺丝，含安全销。5-侧面 TORX PLUS® 表面，防盗孔。

1/4"六角，适合符合 DIN ISO 1173-F 6.3 标准的接头。

867/4 IPR TORX PLUS® 防盗增强型梅花螺丝批头



	EAN		⌀	ℓ	ℓ ₁	∅		
Code	4013288		mm	mm	mm	mm		
05160821001	160867	10 IPR	50	2"	4,0			10
05134657001	155665	10 IPR	89	3 1/2"	4,0			10
05134654001	155641	15 IPR	50	2"	4,0			10
05134720001	037206	15 IPR	89	3 1/2"	4,0			10
05204126001	160874	20 IPR	50	2"	4,5			10
05259135001	160881	20 IPR	89	3 1/2"	4,5			10
05134655001	155658	25 IPR	50	2"	6,0			10
05134722001	160904	25 IPR	89	3 1/2"	6,0			10
05134656001	156952	27 IPR	50	2"	6,0			10
05134658001	155672	27 IPR	89	3 1/2"	6,0			10
05134732001	160911	30 IPR	50	2"	6,0			10
05134723001	160935	30 IPR	89	3 1/2"	6,0			10

双重抗扭系统 – 给您更长的应用周期

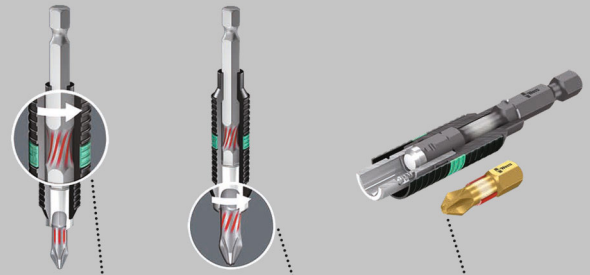

双重抗扭设计 接杆吸收一小部分扭力

大部分的扭力会被批头上标示的双重抗扭区吸收

正常使用下的扭力冲击，并不会造成不必要的磨损

800/1 BDC 一字螺丝批头

批头适用于一字螺丝，尖部带细微金刚石颗粒。由此确保批头在螺丝内配合到位，减少所需的接触压力，并降低打滑风险。

带扭力区，可在峰值负荷状态下分散动能。由此极大延长了产品使用寿命；1/4"六角，适用于符合 DIN ISO 1173-D 6.3 标准的固持器

800/1 BDC 一字螺丝批头



	EAN	ℓ	ℓ ₁	ℓ ₂	ℓ ₃			
Code	4013288	mm	mm	mm	mm			
05056172001	033949	0,8	5,5	25	1"			10
05056174001	033956	1,0	5,5	25	1"			10
05056176001	033963	1,2	6,5	25	1"			10

800/1 BTZ 一字螺丝批头

带扭力区, 可在峰值负荷状态下分散动能。由此极大延长了产品使用寿命。

坚固且韧性强, 适合通用型应用; 1/4"六角, 适用于符合 DIN ISO 1173-D 6.3 标准的固持器。

800/1 BTZ 一字螺丝批头



Code	EAN	mm	mm	mm	mm	mm	mm	mm
05056064001	034427	0,8	5,5	25	1"			10
05056066001	034434	1,0	5,5	25	1"			10
05056068001	034441	1,2	6,5	25	1"			10

800/1 TZ 一字螺丝批头

TZ抗扭批头通过杆部的较小直径, 让批头抵抗冲击的能力有显著提高, 从而避免提早崩坏的情况。维拉设计的缓冲吸收型批头能避免批头头部的早期断裂。该批头可通过产品目录中的产品字母Z来识别。1/4"六角, 适用于 DIN ISO 1173-D 6.3批头接头。

800/1 TZ 一字螺丝批头



Code	EAN	mm	mm	mm	mm	mm	mm	mm
05056203001	011145	0,5	4,0	25	1"	4,0		10
05056210001	011152	0,6	4,5	25	1"	4,5		10
05056220001	011169	0,8	5,5	25	1"	5,5		10
05056225001	011176	1,0	5,5	25	1"	5,5		10
05056233001	011183	1,2	6,5	25	1"	6,2		10
05056240001	011190	1,6	8,0	25	1"	8,0		10

800/1 Z 一字螺丝批头

耐用, 通用型。

1/4"六角, 适用于DIN ISO 1173-D 6.3批头接头。

800/1 Z 一字螺丝批头



Code	EAN	mm	mm	mm	mm	mm	mm	mm
05056200001	040831	0,5	3,0	25	1"	3,0		10
05072050001	030467	0,5	4,0	25	1"	4,0		10
05072055001	010933	0,6	4,5	25	1"	4,5		10
05072057001	010940	0,8	5,5	25	1"	5,5		10
05072059001	010957	1,0	5,5	25	1"	5,5		10
05072061001	010964	1,2	6,5	25	1"	6,2		10
05072063001	030450	1,2	8,0	25	1"	8,0		10
05072065001	010971	1,6	8,0	25	1"	8,0		10

Kraftform 不锈钢系列 – 避免生锈

维拉的不锈钢工具通过真空冰淬以达到所需硬度和强度, 可满足工业级别的应用。

不锈钢材质避免外因锈蚀形成

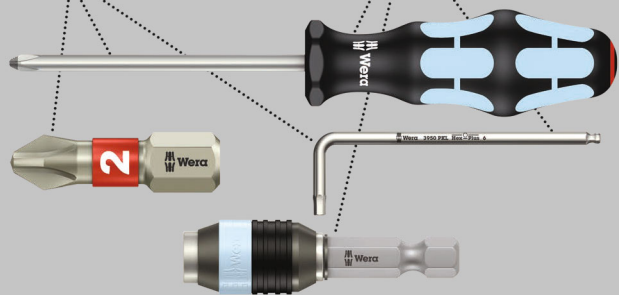

维拉不锈钢批头是由不锈钢材料制成, 可有效避免锈蚀。维拉的不锈钢批头通过真空冰淬以达到所需硬度和强度, 可满足工业级别应用。生锈问题的解决方案: 使用不锈钢工具拆装不锈钢螺丝。维拉不锈钢工具是由不锈钢材料制成, 可有效避免难看的锈蚀。抗扭批头通过缩小中间杆部的直径, 让批头抵抗冲击的能力有显著提高, 从而避免提早失效的情况。1/4"六角, 适用于DIN ISO 1173-F 6.3批头接头。

3800/4 不锈钢一字螺丝批头



Code	EAN	mm	mm	mm	mm	mm	mm	mm
05071080001	115669	1,0	5,5	89	3 1/2"			10

800/4 Z 一字螺丝批头

耐用, 通用型。

1/4"六角, 适用于DIN ISO 1173-F 6.3批头接头。

800/4 Z 一字螺丝批头



	EAN	√	√	√	√	∅	
Code	4013288	mm	mm	mm	mm	mm	
05059305001	011480	0,5	3,0	50	2"	3,0	10
05059466001	011497	0,5	3,0	70	2 3/4"	3,0	10
05059307001	011503	0,5	4,0	50	2"	4,0	10
05059310001	011510	0,6	3,5	50	2"	3,5	10
05059472001	011527	0,6	3,5	70	2 3/4"	3,5	10
05059450001	031471	0,6	3,5	152	6"	3,5	10
05059315001	011534	0,6	4,5	50	2"	4,5	10
05059489001	094230	0,6	4,5	89	3 1/2"	4,5	10
05059320001	011541	0,8	4,0	50	2"	4,0	10
05059478001	011558	0,8	4,0	70	2 3/4"	4,0	10
05059480001	011565	0,8	4,0	89	3 1/2"	4,0	10
05059451001	031389	0,8	4,0	152	6"	4,0	10
05059325001	011572	0,8	5,5	50	2"	5,5	10
05059330001	011589	1,0	5,5	50	2"	5,5	10
05059486001	011596	1,0	5,5	70	2 3/4"	5,5	10
05059488001	011602	1,0	5,5	89	3 1/2"	5,5	10
05059452001	031235	1,0	5,5	152	6"	5,5	10
05059335001	035004	1,0	6,0	50	2"	6,0	10
05059337001	011619	1,2	6,5	50	2"	6,2	10
05059492001	011626	1,2	6,5	70	2 3/4"	6,2	10
05059490001	094247	1,2	6,5	89	3 1/2"	6,2	10
05059453001	031488	1,2	6,5	152	6"	6,2	10
05059340001	011633	1,2	8,0	50	2"	8,0	10
05059496001	011640	1,2	8,0	89	3 1/2"	8,0	10
05059345001	011657	1,6	8,0	50	2"	8,0	10
05059500001	011664	1,6	8,0	89	3 1/2"	8,0	10

800/2 Z 一字螺丝批头

具有韧性, 通用型。

5/16"六角, 适用于DIN ISO 1173-D 8批头接杆。

800/2 Z 一字螺丝批头



	EAN	√	√	√	√	∅	
Code	4013288	mm	mm	mm	mm	mm	
05057225001	011275	1,2	8,0	41	1 19/32"	7,8	10
05057235001	011299	1,6	10,0	41	1 19/32"	7,8	10
05057240001	011305	2,0	12,0	41	1 19/32"	12,0	10

800/9 C 一字螺丝批头

硬度更高。4mm半月驱动 (维拉驱动转换系列9。硬质)。

800/9 C 一字螺丝批头



	EAN	√	√	√	√	∅	
Code	4013288	mm	mm	mm	mm	mm	
05135265001	168276	0,23	1,5	44	1 47/64"	1,5	10
05135264001	194770	0,35	2,5	44	1 47/64"	2,5	10
05135266001	168283	0,40	2,0	44	1 47/64"	2,0	10
05135267001	168290	0,50	3,0	44	1 47/64"	3,0	10

抗冲击系统 – 为了极限需求而设计



维拉不锈钢批头是由不锈钢材料制成, 可有效避免锈蚀。维拉的不锈钢批头通过真空冰淬以达到所需硬度和强度, 可满足工业级别应用。

生锈问题的解决方案: 使用不锈钢工具拆装不锈钢螺丝。维拉不锈钢工具是由不锈钢材料制成, 可有效避免难看的锈蚀。

抗扭批头通过缩小中间杆部的直径, 让批头抵抗冲击的能力有显著提高, 从而避免提早失效的情况。1/4"六角, 适用于DIN ISO 1173-D 6.3批头接头。

840/1 IMP DC 增强型六角 DIY Impaktor 批头

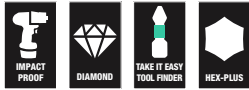

Code	EAN			
	4013288			
05057603001	178701	840/1 IMP DC 10x 3.0x25	1	
05057604001	157560	840/1 IMP DC 10x 4.0x25	1	
05057605001	157423	840/1 IMP DC 10x 5.0x25	1	
05057606001	157430	840/4 IMP DC 10x 6.0x25	1	

840/1 IMP DC 内六角螺丝冲击批头吊卡装

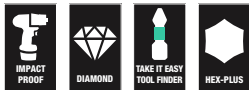

Code	EAN			
	4013288			
05073904001	158338	840/1 IMP DC 1x 4.0x25	5	
05073905001	158345	840/1 IMP DC 1x 5.0x25	5	
05073906001	158352	840/1 IMP DC 1x 6.0x25	5	

Kraftform 不锈钢系列 – 避免生锈

维拉的不锈钢工具通过真空冰淬以达到所需硬度和强度，可满足工业级别的应用。

不锈钢材质避免外因锈蚀形成

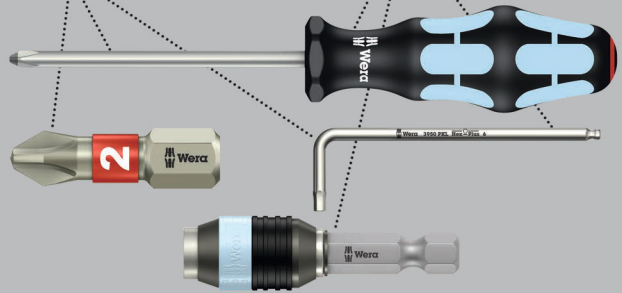

维拉不锈钢批头是由不锈钢材料制成，可有效避免锈蚀。维拉的不锈钢批头通过真空冰淬以达到所需硬度和强度，可满足工业级别应用。生锈问题的解决方案：使用不锈钢工具拆装不锈钢螺丝。

维拉不锈钢工具是由不锈钢材料制成，可有效避免难看的锈蚀。抗扭批头通过缩小中间杆部的直径，让批头抵抗冲击的能力有显著提高，

从而避免提早失效的情况。1/4"六角，适用于DIN ISO 1173-D 6.3批头接头。

3840/1 TS 不锈钢内六角螺丝批头



Code	EAN	mm	mm	mm	mm	mm	mm	mm	mm	
05071070001	111197	1,5	25	1"						10
05071071001	111203	2,0	25	1"						10
05071072001	111210	2,5	25	1"						10
05071073001	111227	3,0	25	1"						10
05071074001	111234	4,0	25	1"						10
05071075001	111241	5,0	25	1"						10
05071077001	115478	5,5	25	1"						10
05071076001	111258	6,0	25	1"						10



双重抗扭系统 – 给您更长的应用周期

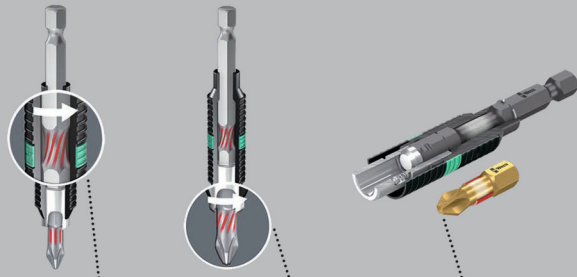

双重抗扭设计 接杆吸收一小部分扭力

大部分的扭力会被批头上标示的双重抗扭区吸收

正常使用下的扭力冲击, 并不会造成不必要的磨损

适用于六角螺丝的 BiTorsion 批头, 带扭力区, 可在峰值负荷状态下分散动能。

由此显著提升了产品使用寿命。超高硬度设计。

1/4"六角, 适用于符合 DIN ISO 1173-D 6.3 的固持器。

840/1 BTZ 内六角螺丝批头



Code	EAN	mm	mm				
05056680001	182418	1,5	25	1"			10
05056681001	182425	2,0	25	1"			10
05056682001	182432	2,5	25	1"			10
05056683001	182449	3,0	25	1"			10
05056684001	182456	4,0	25	1"			10
05056685001	182463	5,0	25	1"			10
05056686001	182470	5,5	25	1"			10
05056687001	182487	6,0	25	1"			10

增强型内六角- 专门针对六角型螺丝的设计

如图可看到和螺槽的接触面积大幅度的增加 因此减少了转位时各个面所承受的压力

从而避免破坏螺丝凹槽的轮廓

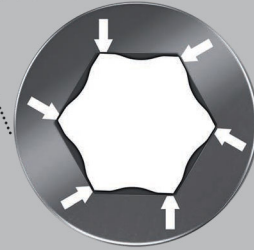

内六角螺丝存在一个问题, 由于从扳手头传递外力到螺丝的接触面很窄, 导致螺丝头可能会损坏, 通常是凹处被磨圆。Hex-Plus工具有较大的接触面, 可防止这种损坏。它从凹槽的平面处驱动螺丝, 而不是从角面, 因此和一般L型扳手相比增加了20%可以被传递的扭矩。并且Hex-Plus工具适合每一个标准内六角螺丝! 1/4"六角, 适用于DIN ISO 1173-D 6.3批头接头。

840/1 Z 内六角螺丝批头



Code	EAN	mm	mm				
05056303001	012623	1,5	25	1"			10
05056305001	012630	2,0	25	1"			10
05056310001	012647	2,5	25	1"			10
05056315001	012654	3,0	25	1"			10
05056320001	012661	4,0	25	1"			10
05056325001	012678	5,0	25	1"			10
05056330001	012685	6,0	25	1"			10
05056332001	038173	7,0	25	1"			10
05056335001	012692	8,0	25	1"			10
05056340001	012708	10,0	25	1"			10
05135060001	106636		0,05"	25	1"		10
05135070001	040862		1/16"	25	1"		10
05135071001	040879		5/64"	25	1"		10
05135072001	037725		3/32"	25	1"		10
05135078001	036599		7/64"	25	1"		10
05135073001	038067		1/8"	25	1"		10
05135069001	040855		9/64"	25	1"		10
05135074001	036506		5/32"	25	1"		10
05135075001	037930		3/16"	25	1"		10
05135079001	040893		7/32"	25	1"		10
05135076001	040886		1/4"	25	1"		10
05135077001	036360		5/16"	25	1"		10
05135068001	040848		3/8"	25	1"		10

840/1 Z 内六角螺丝批头吊卡装



Code	EAN			
	4013288			
05073050001	202567	⊙	840/1 Z Hex-Plus 2x 2.0x25	5
05073051001	202550	⊙	840/1 Z Hex-Plus 2x 2.5x25	5
05073052001	202512	⊙	840/1 Z Hex-Plus 2x 3.0x25	5
05073053001	202529	⊙	840/1 Z Hex-Plus 2x 4.0x25	5
05073054001	202536	⊙	840/1 Z Hex-Plus 2x 5.0x25	5
05073055001	202543	⊙	840/1 Z Hex-Plus 2x 6.0x25	5
05073342001	029607	⊙	840/1 Z Hex-Plus 1x 2.0x25; 1x 2.5x25; 1x 3.0x25	5
05073344001	029614	⊙	840/1 Z Hex-Plus 1x 4.0x25; 1x 5.0x25; 1x 6.0x25	5

842/1 Z 内六角螺丝批头

球头驱动意味着轴身可以绕着螺丝旋转，因而可以在狭窄区域利用角度进行螺丝拆装。

1/4"六角，适用于DIN ISO 1173-D 6.3批头接头。

842/1 Z 内六角螺丝批头



Code	EAN	⊙	⊘	⊘				
	4013288	mm	mm					
05056350001	013156	2,5	25	1"				10
05056352001	013163	3,0	25	1"				10
05056354001	013170	4,0	25	1"				10
05056356001	013187	5,0	25	1"				10
05056358001	013194	6,0	25	1"				10

抗冲击系统 – 为了极限需求而设计



维拉不锈钢批头是由不锈钢材料制成，可有效避免锈蚀。维拉的不锈钢批头通过真空冰淬以达到所需硬度和强度，可满足工业级别应用。

生锈问题的解决方案：使用不锈钢工具拆装不锈钢螺丝。

维拉不锈钢工具是由不锈钢材料制成，可有效避免难看的锈蚀。抗扭批头通过缩小中间杆部的直径，让批头抵抗冲击的能力有显著提高，从而避免提早失效的情况。1/4"六角，适用于DIN ISO 1173-F 6.3批头接头。

840/4 IMP DC 增强型六角 DIY Impaktor 批头

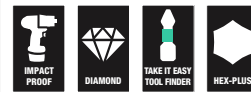

Code	EAN			
	4013288			
05057644001	157577	⊙	840/4 IMP DC 5x 4.0x50	1
05057645001	157492	⊙	840/4 IMP DC 5x 5.0x50	1
05057646001	157508	⊙	840/4 IMP DC 5x 6.0x50	1



840/4 IMP DC 内六角螺丝冲击批头吊卡装



Code	EAN			
05073944001	158451	○	840/4 IMP DC 1x 4.0x50	5
05073945001	158468	○	840/4 IMP DC 1x 5.0x50	5
05073946001	158475	○	840/4 IMP DC 1x 6.0x50	5

Kraftform 不锈钢系列 – 避免生锈

维拉的不锈钢工具通过真空冰处以达到所需硬度和强度，可满足工业级别的应用。

不锈钢材质避免外因锈蚀形成

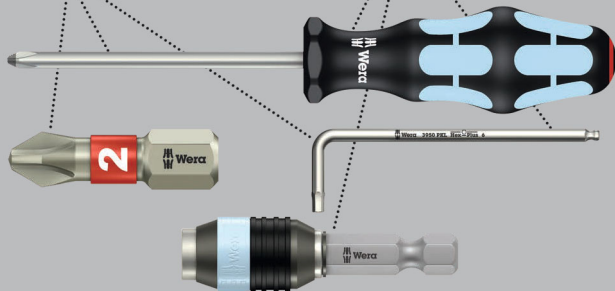

维拉不锈钢批头是由不锈钢材料制成，可有效避免锈蚀。维拉的不锈钢批头通过真空冰淬以达到所需硬度和强度，可满足工业级别应用。生锈问题的解决方案：使用不锈钢工具拆装不锈钢螺丝。维拉不锈钢工具是由不锈钢材料制成，可有效避免难看的锈蚀。抗扭批头通过缩小中间杆部的直径，让批头抵抗冲击的能力有显著提高，从而避免提早失效的情况。

1/4"六角，适用于DIN ISO 1173-F 6.3批头接头。

3840/4 不锈钢内六角螺丝批头



	EAN	○	○	┌	└			
Code	4013288	mm		mm				
05071101001	115621	3,0		89	3 1/2"			10
05071102001	115638	4,0		89	3 1/2"			10
05071103001	115645	5,0		89	3 1/2"			10
05071104001	115652	6,0		89	3 1/2"			10
05071105001	115676		3/32"	89	3 1/2"			10
05071106001	115683		1/8"	89	3 1/2"			10
05071107001	115690		5/32"	89	3 1/2"			10
05071108001	115706		3/16"	89	3 1/2"			10

增强型内六角- 专门针对六角型螺丝的设计

如图可看到和螺槽的接触面积大幅度的增加 因此减少了
转位时各个面所承受的压力

从而避免破坏螺丝凹槽的轮廓

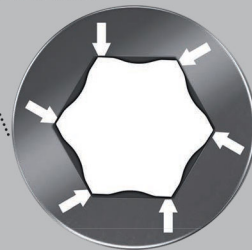

840/4 Z Take it easy 批头

- “易寻”色标系统：用特定的颜色代表不同端头种类和尺寸

840/4 Z 内六角螺丝批头



	EAN	⌀	⌀	L	L	∅		
Code	4013288	mm		mm		mm		
05160885001	200976	0,9		50	2"	2,6		10
05059602001	112408	1,5		50	2"	2,0		10
05059603001	034694	2,0		50	2"	4,0		10
05059628001	155450	2,0		89	3 1/2"	4,0		5
05059604001	034700	2,5		50	2"	4,0		10
05059629001	155467	2,5		89	3 1/2"	4,0		5
05059605001	012906	3,0		50	2"	4,0		10
05059630001	094254	3,0		89	3 1/2"	4,0		5
05380033001	156433	3,0		152	6"	4,0		5
05059610001	012913	4,0		50	2"	5,0		10
05059631001	094261	4,0		89	3 1/2"	5,0		5
05059634001	122964	4,0		152	6"	5,0		5
05059615001	012920	5,0		50	2"	6,0		10
05059632001	094278	5,0		89	3 1/2"	6,0		5
05059635001	122971	5,0		152	6"	6,0		5
05059620001	012937	6,0		50	2"	5,0		10
05059633001	094285	6,0		89	3 1/2"	-		5
05059636001	122988	6,0		152	6"	-		5
05059625001	012944	8,0		50	2"	-		10
05059637001	215031	8,0		89	3 1/2"	-		5
05350430001	161406		0,05"	50	2"	2,5		10
05135090001	107053		1/16"	50	2"	2,5		10
05380045001	156730		1/8"	152	6"	4,0		5
05135091001	036414		5/64"	50	2"	3,0		10
05059660001	155474		5/64"	89	3 1/2"	3,0		5
05135092001	036421		3/32"	50	2"	3,0		10
05059661001	155481		3/32"	89	3 1/2"	3,5		5
05135093001	036438		7/64"	50	2"	3,5		10
05059662001	155498		7/64"	89	3 1/2"	4,0		5
05135094001	036445		1/8"	50	2"	4,0		10
05059663001	155504		1/8"	89	3 1/2"	4,0		5
05135095001	036377		9/64"	50	2"	4,5		10
05059664001	155511		9/64"	89	3 1/2"	4,5		5
05380046001	156822		9/64"	152	6"	4,5		5
05135096001	036384		5/32"	50	2"	5,0		10
05059665001	155528		5/32"	89	3 1/2"	5,0		5
05380047001	156839		5/32"	152	6"	5,0		5
05135097001	036391		3/16"	50	2"	6,0		10
05059666001	155535		3/16"	89	3 1/2"	6,0		5
05380048001	156846		3/16"	152	6"	6,0		5
05135098001	036407		7/32"	50	2"	-		10
05059667001	155542		7/32"	89	3 1/2"	-		5
05380049001	156853		7/32"	152	6"	-		5
05135099001	095589		1/4"	50	2"	-		10
05059668001	155559		1/4"	89	3 1/2"	-		5
05380050001	156860		1/4"	152	6"	-		5
05346288001	103895		5/16"	50	2"	-		10

840/4 Z SB 六角批头



Code	EAN			
05073056001	202468	⊙	840/4 Z Hex-Plus 2x 2.0x50	3
05073057001	202475	⊙	840/4 Z Hex-Plus 2x 2.5x50	3
05073058001	202482	⊙	840/4 Z Hex-Plus 2x 3.0x50	3
05136301001	213792	⊙	840/4 Z Hex-Plus 1x 3.0x152	3
05073059001	202499	⊙	840/4 Z Hex-Plus 2x 4.0x50	3
05136302001	213808	⊙	840/4 Z Hex-Plus 1x 4.0x152	3
05073060001	202505	⊙	840/4 Z Hex-Plus 2x 5.0x50	3
05136303001	213815	⊙	840/4 Z Hex-Plus 1x 5.0x152	3
05073061001	202444	⊙	840/4 Z Hex-Plus 2x 6.0x50	3
05136304001	213822	⊙	840/4 Z Hex-Plus 1x 6.0x152	3



842/4 内六角螺丝批头

球头驱动意味着轴身可以绕着螺丝旋转，因而在狭窄区域利用角度进行螺丝拆装。 $\frac{1}{4}$ "六角，适用于DIN ISO 1173-F 6.3批头接头。

842/4 内六角螺丝批头



Code	EAN	⌀	⌀	⌀	⌀		
05059680001	155931	3,0		89	3 1/2"		5
05059681001	155948	4,0		89	3 1/2"		5
05059682001	155955	5,0		89	3 1/2"		5
05059683001	155962	6,0		89	3 1/2"		5
05380124001	156587		3/32"	89	3 1/2"		5
05380125001	156594		7/64"	89	3 1/2"		5
05380126001	156600		1/8"	89	3 1/2"		5
05380127001	156617		9/64"	89	3 1/2"		5
05380128001	156624		5/32"	89	3 1/2"		5
05380129001	156631		3/16"	89	3 1/2"		5
05380130001	156648		7/32"	89	3 1/2"		5
05380131001	156655		1/4"	89	3 1/2"		5

840/2 Z 内六角螺丝批头

Hex-Plus六角增强型，具有韧性，通用型。内六角螺丝存在一个问题，由于从扳手头传递外力到螺丝的接触面很窄，导致螺丝头可能会损坏，通常是凹处被磨圆。Hex-Plus花形有较大的接触面，可防止这种损坏。它从凹槽的平面处驱动螺丝，而不是从角面，因此和一般L型扳手相比增加了20%可以被传递的扭矩。并且Hex-Plus工具适合每一个标准内六角螺丝。

840/2 Z 内六角螺丝批头



Code	EAN	⌀	⌀	⌀	⌀		
05057505001	012753	3		30	1 3/16"		10
05057510001	012760	4		30	1 3/16"		10
05057515001	012777	5		30	1 3/16"		10
05057520001	012784	6		30	1 3/16"		10
05057525001	012791	8		30	1 3/16"		10
05057530001	012807	10		30	1 3/16"		10

840/9 C 内六角螺丝批头

传动: 4mm半月形

840/9 C 内六角螺丝批头



Code	EAN	⌀	⌀	⌀	⌀		
05135268001	168306	1,5	44	1 47/64"	2,6		10
05135269001	168313	2,0	44	1 47/64"	2,6		10

840/1 Z Hex-Plus B0 防盗内六角螺丝批头

Hex-Plus六角增强型，带安全销，耐用，通用型。

传动: $\frac{1}{4}$ "六角，适用于DIN ISO 1173-D 6.3标准的批头接头

840/1 Z Hex-Plus B0 防盗内六角螺丝批头



Code	EAN	⌀	⌀	⌀	⌀		
05056341001	038548	2,0	25	1"			10
05056342001	038555	2,5	25	1"			10
05056343001	038562	3,0	25	1"			10
05056344001	038593	4,0	25	1"			10
05056345001	038579	5,0	25	1"			10
05056346001	038586	6,0	25	1"			10

840/4 Z Hex-Plus B0 防盗内六角螺丝批头

传动: 1/4"六角, 适用于DIN ISO 1173-F 6.3标准的批头接头

840/4 Z Hex-Plus B0 防盗内六角螺丝批头



	EAN	⊙	⊘	⊘	⊘		📦
Code	4013288	mm	mm		mm		
05059640001	094292	2,0	89	3 1/2"	4,0		5
05059641001	094308	2,5	89	3 1/2"	4,0		5
05059642001	094315	3,0	89	3 1/2"	4,0		5
05059643001	094322	4,0	89	3 1/2"	5,0		5
05059644001	094339	5,0	89	3 1/2"	6,0		5
05059645001	094346	6,0	89	3 1/2"	-		5

9506 SB 4 合 1 批头 1

四种不同的花形 (六角形套筒螺丝尺寸3.0、4.0、5.0、6.0) 只能用一个批头操作。

显著降低重量50%以上。小尖头的弹簧压缩使大型材具有可操作性。

批头有一个 1/4" 的六角形驱动 (Wera 连接系列 1), 因此也可以与批头棘轮和带有 Rapidaptor 的批头夹持螺丝刀一起使用。

- 创新性、极为紧凑的四头批头 - 四种不同的螺丝尺寸仅有一个批头
- 适用于内六角套筒螺丝尺寸 3.0、4.0、5.0 和 6.0
- 坚固而具有韧性, 用于坚硬材料
- 1/4"六角驱动 (维拉驱动转换系列1)

9506 SB 4 合 1 批头 1

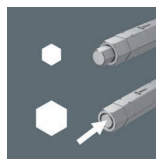
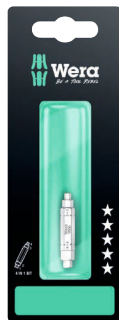

Code	EAN		📦
05073201001	225269		1
		⊙⊙ 9506 1x 3,0; 4,0; 5,0; 6,0x37	

9507 SB 4 合 1 批头 2

四种不同的花形 (六角形套筒螺丝尺寸2.5、5.0、6.0和 TORX® 梅花螺丝尺寸TX 25) 只能用一个批头操作。

可节省大量空间, 特别适合移动使用。

显著降低重量50%以上。小尖头的弹簧压缩使大型材具有可操作性。

批头有一个 1/4" 的六角形驱动 (Wera 连接系列 1), 也可以与批头棘轮和带有 Rapidaptor 的批头夹持螺丝刀一起使用。

- 创新性、极为紧凑的四头批头 - 四种不同的螺丝尺寸仅有一个批头
- 适用于内六角螺丝尺寸 2.5、5.0、6.0、TORX® 梅花螺丝TX 25
- 坚固而具有韧性, 用于坚硬材料
- 1/4"六角驱动 (维拉驱动转换系列1)

9507 SB 4 合 1 批头 2

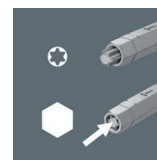
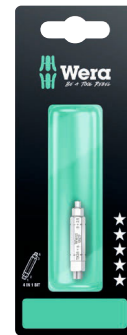

Code	EAN		📦
05073202001	225276		1
		⊙⊙ 9507 1x 2,5; 5,0; 6,0; TX 25x37	



抗冲击系统 – 为了极限需求而设计

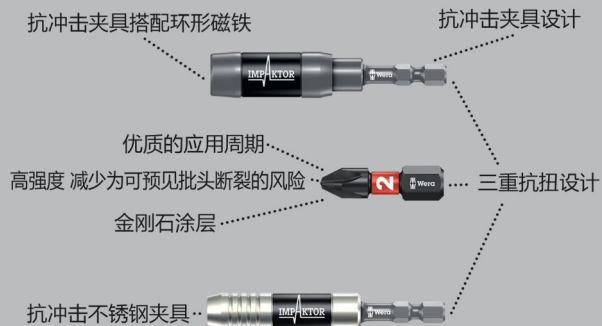

维拉不锈钢批头是由不锈钢材料制成,可有效避免锈蚀。维拉的不锈钢批头通过真空冰淬以达到所需硬度和强度,可满足工业级别应用。生锈问题的解决方案:使用不锈钢工具拆装不锈钢螺丝。维拉不锈钢工具是由不锈钢材料制成,可有效避免难看的锈蚀。抗扭批头通过缩小中间杆部的直径,让批头抵抗冲击的能力有显著提高,从而避免提早失效的情况。1/4"六角,适用于DIN ISO 1173-D 6.3批头接头。

868/1 IMP DC DIY Impaktor 内四方批头套筒



Code	EAN		
05057631001	157478	868/1 IMP DC 10x # 2x25	1
05057632001	157485	868/1 IMP DC 10x # 3x25	1

868/1 IMP DC 内四方螺丝冲击批头吊卡装



Code	EAN		
05073931001	158437	868/1 IMP DC 1x # 2x25	5
05073932001	158444	868/1 IMP DC 1x # 3x25	5

868/1 V 内四方螺丝批头固持功能

V系列批头在驱动头的位置采用小角度的锥形,能够和内四方螺丝紧密的接合,适用于螺丝定位有困难的情况。耐用,通用型。1/4"六角,适用于DIN ISO 1173-D 6.3批头接头。

868/1 V 内四方螺丝批头固持功能



Code	EAN		mm	mm	mm	
05340245001	118202	# 1	25	1"	6,1	10
05066394001	113603	# 2	25	1"	6,1	10
05066396001	169228	# 3	25	1"	6,1	10

Bit-Box 20 V 内四方吊卡装内四方吊卡装批头盒



Code	EAN		
05057790001	188083	868/1 V 20x # 2x25	20

868/1 Z 内四方螺丝批头

坚固而具有韧性的通用批头。

1/4"六角, 适用于DIN ISO 1173-D 6.3标准的批头接头。

868/1 Z 内四方螺丝批头



	EAN						
Code	4013288		mm		mm		
05066395001	030214	# 00	25	1"	3,5		10
05066400001	030221	# 0	25	1"	3,5		10
05066405001	030207	# 1	25	1"	4,5		10
05066410001	030238	# 2	25	1"	6,0		10
05066415001	030245	# 3	25	1"	6,0		10
05066420001	030252	# 4	25	1"	8,0		10

868/1 Z SB Square-plus四方批头



	EAN				
Code	4013288				
05073074001	202727		868/1 Z 2x # 1x25		5
05073075001	202710		868/1 Z 2x # 2x25		5

抗冲击系统 – 为了极限需求而设计

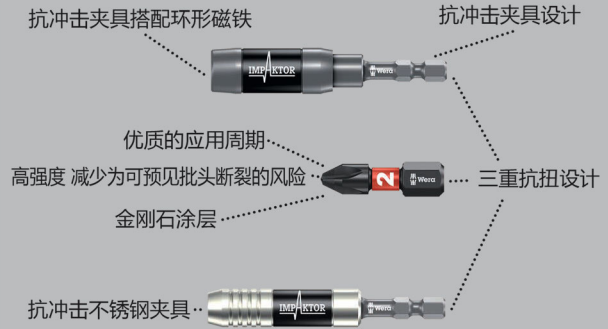

维拉不锈钢批头是由不锈钢材料制成, 可有效避免锈蚀。维拉的不锈钢批头通过真空冰淬以达到所需硬度和强度, 可满足工业级别应用。

生锈问题的解决方案: 使用不锈钢工具拆装不锈钢螺丝。维拉不锈钢工具是由不锈钢材料制成, 可有效避免难看的锈蚀。抗扭批头通过缩小中间杆部的直径, 让批头抵抗冲击的能力有显著提高, 从而避免提早失效的情况。1/4"六角, 适用于DIN ISO 1173-F 6.3批头接头。

868/4 IMP DC DIY Impaktor 内四角批头套筒



	EAN			
Code	4013288			
05057671001	157546		868/4 IMP DC 5x # 2x50	1
05057672001	157553		868/4 IMP DC 5x # 3x50	1



868/4 IMP DC 内四方螺丝冲击批头吊卡装

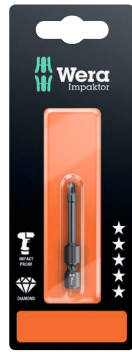

Code	EAN		
05073971001	158550	868/4 IMP DC 1x # 2x50	5
05073972001	158567	868/4 IMP DC 1x # 3x50	5

Kraftform 不锈钢系列 – 避免生锈

维拉的不锈钢工具通过真空冰处以达到所需硬度和强度，可满足工业级别的应用。

不锈钢材质避免外因锈蚀形成

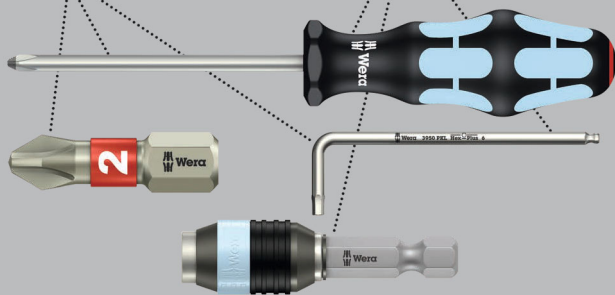

维拉不锈钢批头是由不锈钢材料制成，可有效避免锈蚀。维拉的不锈钢批头通过真空冰淬以达到所需硬度和强度，可满足工业级别应用。生锈问题的解决方案：使用不锈钢工具拆装不锈钢螺丝。维拉不锈钢工具是由不锈钢材料制成，可有效避免难看的锈蚀。抗扭批头通过缩小中间杆部的直径，让批头抵抗冲击的能力有显著提高，从而避免提早失效的情况。1/4"六角，适用于DIN ISO 1173-F 6.3批头接头。

3868/4 不锈钢内四方螺丝批头



Code	EAN					
05071097001	115591	# 1	89	3 1/2"	4,5	10
05071098001	115607	# 2	89	3 1/2"	5,0	10
05071099001	115614	# 3	89	3 1/2"	5,5	10

868/4 BTZ 内四方螺丝批头



Code	EAN					
05060147001	041272	#1	50	2"	4,2	10
05060148001	041289	#2	50	2"	4,2	10
05060149001	041296	#3	50	2"	5,5	10

868/4 内四方螺丝批头



Code	EAN					
05060150001	030269	# 00	50	2"	3,5	10
05060155001	030276	# 0	50	2"	3,5	10
05060160001	030283	# 1	50	2"	4,5	10
05060180001	041043	# 1	70	2 3/4"	4,5	10
05134800001	040930	# 1	89	3 1/2"	4,5	10
05134805001	040923	# 1	152	6"	4,5	10
05060165001	030290	# 2	50	2"	6,0	10
05060182001	041050	# 2	70	2 3/4"	6,0	10
05134801001	040947	# 2	89	3 1/2"	6,0	10
05134806001	040954	# 2	152	6"	6,0	10
05060170001	030306	# 3	50	2"	6,0	10
05060184001	032805	# 3	70	2 3/4"	6,0	10
05134802001	040961	# 3	89	3 1/2"	6,0	10
05134807001	040978	# 3	152	6"	6,0	10
05060175001	030313	# 4	50	2"	8,0	10

868/4 Z SB Square-plus四方 批头



Code	EAN		
05073076001	202703	868/4 Square-Plus 2x # 1x50	5
05073077001	202697	868/4 Square-Plus 2x # 2x50	5

868/4 V 内四方螺丝批头

V系列批头在驱动头的位置采用小角度的锥形，能够和内四方螺丝紧密的接合，适用于螺丝定位有困难的情况。

868/4 V 内四方螺丝批头



	EAN	□	┆	┆	∅		
Code	4013288		mm		mm		
05060300001	169211	# 1	50	2"	4,5		10
05060297001	169198	# 1	89	3 1/2"	4,5		10
05060301001	113610	# 2	50	2"	6,0		10
05060302001	113627	# 2	70	2 3/4"	6,0		10
05060303001	113634	# 2	89	3 1/2"	6,0		10
05060304001	113641	# 2	152	6"	6,0		10
05060296001	169181	# 3	50	2"	6,0		10
05060298001	169204	# 3	89	3 1/2"	6,0		10

金刚石涂层批头

分布在批头尖端的超微金刚石粉末 实实在在的咬合力

批头和螺丝凹槽稳固的贴合

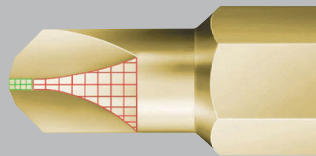

维拉研发的Mplus四翼有更强壮侧翼，可以提高约70%的抗扭强度，显著提高工具的使用寿命。金刚石涂层批头的头部涂敷了微小的金刚石颗粒，能够“咬”紧螺丝头部，有效地降低了操作时滑脱的危险。

871/1 DC TORQ-SET® Mplus 四翼螺丝批头



	EAN	+	+	┆	┆	∅	
Code	4013288	mm		mm		mm	
05066638001	099525	4		25	1"	4,7	10
05066640001	033161	6		25	1"	4,7	10
05066642001	033178	8		25	1"	6,0	10
05066644001	033185	10		25	1"	6,0	10
05066646001	033192	--	1/4"	32	1 1/4"	11,0	10

871/1 TORQ-SET® Mplus 四翼螺丝批头

TORQ-SET® Mplus: 维拉研发的Mplus四翼有更强壮侧翼，可以提高约70%的抗扭强度，显著提高工具的使用寿命。

1/4"六角，适用于DIN ISO 1173-D 6.3批头接头。

871/1 TORQ-SET® Mplus 四翼螺丝批头 · 25 mm



	EAN	+	+	┆	┆	∅	
Code	4013288	mm		mm		mm	
05066618001	093073	0		25	1"	4,7	10
05066619001	041562	1		25	1"	4,7	10
05066620001	033086	2		25	1"	4,7	10
05066622001	033093	3		25	1"	4,7	10
05066624001	033109	4		25	1"	4,7	10
05066626001	033116	5		25	1"	4,7	10
05066628001	033123	6		25	1"	4,7	10
05066630001	033130	8		25	1"	6,0	10
05066632001	033147	10		25	1"	6,0	10
05066633001	037558	--	1/4"	25	1"	6,0	10

871/1 TORQ-SET® Mplus 四翼螺丝批头 · 32 mm



	EAN	+	+	┆	┆	∅	
Code	4013288			mm		mm	
05066634001	033154	1/4"		32	1 1/4"	11,0	10
05066635001	093011	5/16"		32	1 1/4"	11,0	10

871/4 DC TORQ-SET® Mplus 四翼螺丝批头

Mplus设计使得批头可承受更高扭矩，使用寿命更长，金刚石。

1/4"六角，适用于DIN ISO 1173-F 6.3批头接头。

871/4 DC TORQ-SET® Mplus 四翼螺丝批头

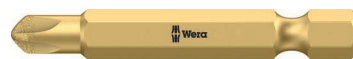

	EAN	+	+	┆	┆		
Code	4013288			mm			
05324901001	162984	2		50	2"		10
05066688001	099532	4		50	2"		10
05066690001	033345	6		50	2"		10
05066692001	033352	8		50	2"		10
05066694001	033369	10		50	2"		10
05066696001	033376	--	1/4"	50	2"		10



871/4 TORQ-SET® Mplus 四翼螺丝批头



	EAN						
Code	4013288			mm			
05066660001	033239	2		50	2"		10
05066683001	094469	2		89	3 1/2"		5
05066662001	033246	3		50	2"		10
05066684001	094476	3		89	3 1/2"		5
05066664001	033253	4		50	2"		10
05066685001	094483	4		89	3 1/2"		5
05066666001	033260	5		50	2"		10
05066668001	033277	6		50	2"		5
05066676001	033307	6		70	2 3/4"		5
05066686001	094490	6		89	3 1/2"		10
05066670001	033055	8		50	2"		10
05066678001	033314	8		70	2 3/4"		5
05066687001	094506	8		89	3 1/2"		10
05066672001	033284	10		50	2"		10
05066680001	033321	10		70	2 3/4"		5
05066682001	033338	10		89	3 1/2"		5
05066674001	033291	--	1/4"	50	2"		10
05221110001	035851	--	5/16"	50	2"		10

871/2 TORQ-SET® Mplus 四翼螺丝批头

具有韧性, 通用型。5/16"六角, 适用于 DIN ISO 1173-D 8批头接杆。

871/2 TORQ-SET® Mplus 四翼螺丝批头



	EAN					
Code	4013288		mm			
05066654001	033208	1/4"	32	1 1/4"		5
05066656001	033215	5/16"	32	1 1/4"		5

875/1 TRI-WING® 三翼螺丝批头 · 25 mm

应用: 用于TRI-WING®三翼螺丝。耐用, 通用型。1/4"六角, 适用于DIN ISO 1173-D 6.3标准的批头接头。

875/1 TRI-WING® 三翼螺丝批头 · 25 mm



	EAN						
Code	4013288		mm		mm		
05066758001	093059	0	25	1"	4,7		10
05066760001	033482	1	25	1"	4,7		10
05066762001	033499	2	25	1"	4,7		10
05066764001	033505	3	25	1"	4,7		10
05066766001	033512	4	25	1"	6,2		10
05066768001	033529	5	25	1"	6,2		10

875/4 TRI-WING® 三翼螺丝批头

耐用, 通用型。1/4"六角, 适用于 DIN ISO 1173-F 6.3标准的批头接头。

875/4 TRI-WING® 三翼螺丝批头



	EAN					
Code	4013288		mm			
05066785001	094605	1	89	3 1/2"		5
05066786001	094612	2	89	3 1/2"		5
05066787001	094629	3	89	3 1/2"		5
05066788001	094636	4	89	3 1/2"		5

860/1 XZN 花键螺丝批头

应用: 用于XZN花键螺丝。耐用, 通用型。1/4"六角, 适用于DIN ISO 1173-D 6.3标准的批头接头。

860/1 XZN 花键螺丝批头



	EAN						
Code	4013288		mm		mm		
05066150001	034953	M 4	25	1"	4,17		10
05066155001	034960	M 5	25	1"	5,14		10
05066160001	034977	M 6	25	1"	-		10
05066165001	034984	M 8	25	1"	8,0		5
05066170001	034991	M 10	25	1"	10,0		5

872/9 Microstix® 三叶螺丝批头

传动: 4mm半月形。

872/9 Microstix® 三叶螺丝批头



	EAN						
Code	4013288		mm	mm			
05066850001	179272	m	44	2,0	1 47/64"		10
05066851001	179296	00	44	2,0	1 47/64"		10
05066852001	179302	F	44	2,0	1 47/64"		10
05066853001	179319	0	44	2,0	1 47/64"		10
05066854001	179326	1	44	2,0	1 47/64"		10

857/1 Z 双孔防盗螺丝批头

应用: 用于双孔防盗螺丝。耐用, 通用型。
1/4"六角, 适用于DIN ISO 1173-D 6.3标准的批头接头。

857/1 Z 双孔防盗螺丝批头



	EAN		l ₁	l ₂	∅		
Code	4013288		mm		mm		
05057150001	038609	4	25	1"	3,18		10
05057151001	038616	6	25	1"	4,32		10
05057152001	038623	8	25	1"	5,21		10
05057153001	038630	10	25	1"	6,10		10

857/4 Z 双孔防盗螺丝批头

耐用, 通用型。1/4"六角, 适用于DIN ISO 1173-F 6.3标准的批头接头。

857/4 Z 双孔防盗螺丝批头



	EAN		l ₁	l ₂	∅		
Code	4013288		mm		mm		
05057160001	094810	4	89	3 1/2"	3,18		5
05057161001	094827	6	89	3 1/2"	4,32		5
05057162001	094834	8	89	3 1/2"	5,21		5
05057163001	094841	10	89	3 1/2"	6,10		5

Kraftform 不锈钢系列 – 避免生锈

维拉的不锈钢工具通过真空冰处以达到所需硬度和强度, 可满足工业级别的应用。

不锈钢材质避免外因锈蚀形成

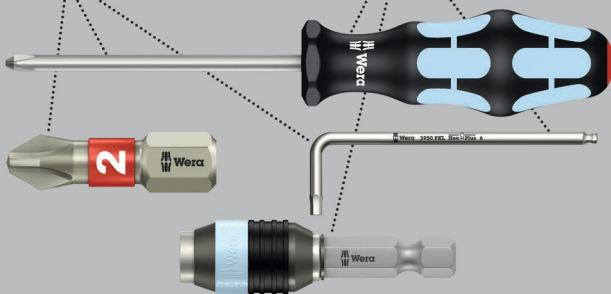

维拉的不锈钢工具通过真空冰处以达到所需硬度和强度, 可满足工业级别的应用。无磁性, 带卡环, 由不锈钢材料制成。1/4"六角, 适用于DIN ISO 1173-F 6.3标准的批头接头。

3869/4 不锈钢螺帽批头



	EAN			l ₁	∅		
Code	4013288			mm	mm		
05071222001	118127	7,0		50,0	12,5		5
05071223001	118257	8,0		50,0	14,0		5
05071224001	118141	10,0		50,0	16,0		5
05071225001	118158	13,0		50,0	19,5		5
05071228001	118189		3/8"	50,0	16,0		5

869/4 螺帽批头

无磁性。1/4"六角, 适用于DIN ISO 1173-F 6.3标准的批头接头。

869/4 螺帽批头



	EAN			l ₁	∅		
Code	4013288			mm	mm		
05060400001	100948	5,5		50,0	11,0		5
05060272001	016546	5,5		65,0	9,0		5
05060401001	100955	6,0		50,0	11,0		5
05060274001	016553	6,0		65,0	11,0		5
05060402001	100962	7,0		50,0	11,0		5
05060276001	016560	7,0		65,0	11,0		5
05060403001	100979	8,0		50,0	12,5		5
05060278001	016577	8,0		65,0	12,5		5
05060404001	100986	9,0		50,0	14,0		5
05060280001	016584	9,0		65,0	14,0		5
05060405001	100993	10,0		50,0	14,0		5
05060282001	016591	10,0		65,0	14,0		5
05060406001	101006	11,0		50,0	16,0		5
05060281001	031327	11,0		65,0	16,0		5
05060407001	101013	12,0		50,0	18,0		5
05060283001	031334	12,0		65,0	18,0		5
05060408001	101020	13,0		50,0	18,0		5
05060284001	016607	13,0		65,0	19,0		5
05060409001	101037		1/4"	50,0	11,0		5
05060286001	016614		1/4"	65,0	11,0		5
05060410001	101044		5/16"	50,0	12,5		5
05060290001	016638		5/16"	65,0	12,5		5
05060411001	101051		3/8"	50,0	14,0		5
05060288001	016621		3/8"	65,0	14,0		5
05060412001	101068		7/16"	50,0	16,0		5



869/4 M 磁性螺帽批头



	EAN						
Code	4013288	mm		mm	mm		
05060420001	101075	5,5		50,0	11,0		5
05060210001	016652	5,5		65,0	11,0		5
05060421001	101082	6,0		50,0	11,0		5
05060215001	016669	6,0		65,0	11,0		5
05060422001	101099	7,0		50,0	11,0		5
05060220001	016676	7,0		65,0	11,0		5
05060423001	101105	8,0		50,0	12,5		5
05060225001	016683	8,0		65,0	12,5		5
05060424001	101112	9,0		50,0	14,0		5
05060230001	016690	9,0		65,0	14,0		5
05060425001	101129	10,0		50,0	14,0		5
05060235001	016706	10,0		65,0	14,0		5
05060426001	101136	11,0		50,0	16,0		5
05060237001	031501	11,0		65,0	16,0		5
05060427001	101143	12,0		50,0	18,0		5
05060238001	031495	12,0		65,0	17,0		5
05060428001	101150	13,0		50,0	18,0		5
05060240001	016713	13,0		65,0	19,0		5
05060429001	101167		1/4"	50,0	11,0		5
05060255001	016720		1/4"	65,0	11,0		5
05060430001	101174		5/16"	50,0	12,5		5
05060260001	016737		5/16"	65,0	12,5		5
05060431001	101181		3/8"	50,0	14,0		5
05060265001	016744		3/8"	65,0	14,0		5
05060432001	101198		7/16"	50,0	16,0		5

869/4 M 磁性螺母批头吊卡装



Code	EAN			
	4013288			
05073500001	105691		869/4 M 1x 5.5x50.0	3
05073501001	105707		869/4 M 1x 6.0x50.0	3
05073502001	106506		869/4 M 1x 7.0x50.0	3
05073503001	105714		869/4 M 1x 8.0x50.0	3
05073504001	105721		869/4 M 1x 9.0x50.0	3
05073505001	105738		869/4 M 1x 10.0x50.0	3
05073506001	105745		869/4 M 1x 11.0x50.0	3
05073507001	105752		869/4 M 1x 12.0x50.0	3
05073508001	105769		869/4 M 1x 13.0x50.0	3
05073509001	105776		869/4 M 1x 1/4"x50.0	3
05073510001	105783		869/4 M 1x 3/8"x50.0	3

869/4 M 组套 A SB



Code	EAN			
05073495001	144584		869/4 M 1x 7.0x50.0; 1x 8.0x50.0; 1x 10.0x50.0; 1x 12.0x50.0; 1x 13.0x50.0; 1x 1/4"x50.0; 1x 5/16"x50.0; 1x 3/8"x50.0	1

869/9 螺帽批头

应用: 用于六角头螺栓、螺丝和螺帽。无磁性。传动: 4mm半月形。

869/9 螺帽批头



	EAN							
Code	4013288	mm	mm	mm				
05135224001	190505	2,5	44,0	5,0				10
05135225001	190499	3,0	44,0	5,0				10

879/4 螺柱批头

应用: 吊架螺栓和螺杆。传动: 1/4"六角, 适用于 DIN ISO 1173-F 6.3标准的批头接杆。设计: 内螺纹。

879/4 螺柱批头



	EAN							
Code	4013288		mm		mm			
05135903001	035059	M8	50,0	2"	12,0			5
05135904001	035066	M10	50,0	2"	12,0			5





夹具和转接头



抗冲击系统 – 为了极限需求而设计



带卡环和磁铁的不锈钢冲击接头可满足一些极端需求。它更注重基本的批头夹持功能，利用两个不同扭力区对达到极端峰值时的冲击形成缓冲。

它主要应用于装配机器人等工业级螺丝安装作业。

输出：用于DIN ISO 1173-C 6.3标准的 $\frac{1}{4}$ "六角头驱动批头，以及维拉系列1的批头。传动： $\frac{1}{4}$ "六角，适用于DIN ISO 1173-F 6.3标准接头的电动工具。

897/4 IMP 冲击接杆 · 带卡环和环形磁铁



Code	EAN					
05057675001	157805	$\frac{1}{4}$ "	75	3"	$\frac{1}{4}$ "	5

897/4 IMP R 冲击接杆 · 带卡环和环形磁铁

环形磁铁可轻松夹持较长较重的螺丝，适合架空作业，尤其适合于冲击电动工具一起使用，磁铁缩回即禁用。输出：用于DIN ISO 1173-C 6.3标准的 $\frac{1}{4}$ "六角头驱动批头，以及维拉系列1的批头。

传动： $\frac{1}{4}$ "六角，适用于DIN ISO 1173-F 6.3标准接头的电动工具。

897/4 IMP R 冲击接杆 · 带卡环和环形磁铁



Code	EAN					
05057676001	157812	$\frac{1}{4}$ "	75	3"	$\frac{1}{4}$ "	5

897/4 IMP R 冲击夹具吊卡装 · 带卡环和环形磁铁



Code	EAN					
0507399001	157836				897/4 Impaktor R 1x $\frac{1}{4}$ "x75	3

Rapidaptor 快速批头接杆 – 令人惊艳的多功能工具

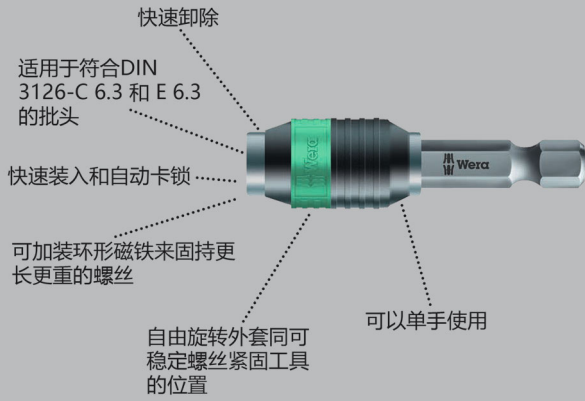

用于DIN ISO 1173-C 6.3和E 6.3标准的1/4"内六角批头，以及维拉系列1和4的批头。不锈钢快速接杆由不锈钢制成，在操作不锈钢工件时可有效避免锈蚀，并同时具有快速更换技术的所有优点。无需移动护套即可将批头推入接头。一旦批头夹在接头上，即可自动锁住。更换批头时只需将护套向前推，弹簧机构就会将批头从磁性中剥离并解锁，这样批头就可以很容易地拆下来了。特别提示：即使拆卸极小的批头也可以不借助外力。传动：1/4"六角，适用于DIN ISO 1173-F 6.3标准接头的电动工具。

3888/4/1 K 不锈钢通用快速批头接杆



	EAN						
Code	4013288		mm		mm		
0507110001	111487	1/4"	50	2"	1/4"	15,0	5

3888/4/1 K 不锈钢通用快速批头接杆吊卡装



Code	EAN						
05073616001	112170						3
			3888/4/1 K				
			1x 1/4"x50				

双重抗扭系统 – 给您更长的应用周期

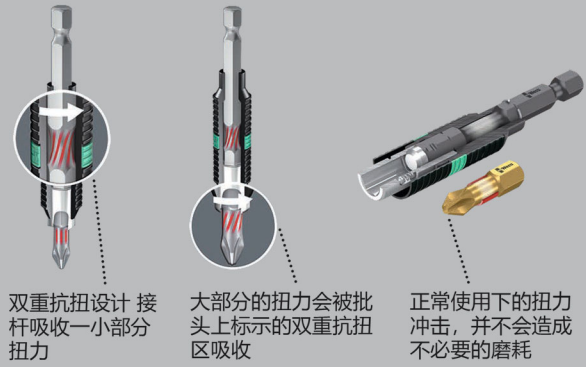

维拉双重抗扭夹具采用了扭力弹簧设计，可吸收螺丝拆装作业期间产生的较小峰值载荷。配合带有扭力区的双重抗扭批头使用时，可显著延长工具的使用寿命。

维拉的双重抗扭夹具也可方便地用在传统批头上。

无需移动护套即可将批头推入接头。一旦批头夹在接头上，即可自动锁住。

更换批头时只需将护套向前推，弹簧机构就会将批头从磁性中剥离并解锁，这样批头就可以很容易地拆下来了。特别提示：即使拆卸极小的批头也可以不借助外力。传动：1/4"六角，适用于DIN ISO 1173-F 6.3标准接头的电动工具。

897/4 R 通用双重抗扭快速批头接杆



	EAN						
Code	4013288		mm		mm		
05053923001	095633	1/4"	75	3"	1/4"	15,0	5

897/4 R 通用双重抗扭快速批头接杆吊卡装



Code	EAN						
05073420001	099464						3
			897/4 R				
			1x 1/4"x75				

889/4/1 K 通用快速批头接杆

用于DIN ISO 1173-C 6.3和E 6.3标准的1/4"内六角批头，以及维拉系列1和4的批头。无需移动护套即可将批头推入接头。一旦批头夹在接头上，即可自动锁住。更换批头时只需将护套向前推，弹簧机构就会将批头从磁性中剥离并解锁，这样批头就可以很容易地拆下来了。

特别提示：即使拆卸极小的批头也可以不借助外力。带强磁性磁铁。传动：1/4"六角，适用于DIN ISO 1173-F 6.3标准接头的电动工具。

889/4/1 K 通用快速批头接杆



	EAN							
Code	4013288		mm			mm		
05052502001	095626	1/4"	50	2"	1/4"	15,0		5

889/4/1 K SB Rapidaptor 通用批头接杆



Code	EAN							
05073421001	099440			889/4/1 K	1x 1/4"x50			3

889/4/1 通用快速批头接杆



	EAN							
Code	4013288		mm			mm		
05052503001	098016	1/4"	75	3"	1/4"	15,0		5

889/4 R 通用快速批头接杆



	EAN							
Code	4013288		mm			mm		
05052504001	101242	1/4"	100	4"	1/4"	15,0		2

888/4/1 K 通用快速批头接杆

- 无磁性设计

888/4/1 K 通用快速批头接杆



	EAN							
Code	4013288		mm			mm		
05052500001	095619	1/4"	50	2"	1/4"	15,0		5

887/4 RR 通用快速批头接杆 · 带环形磁铁

用于DIN ISO 1173-C 6.3和E 6.3标准的1/4"内六角批头，以及维拉系列1和4的批头。无需移动护套即可将批头推入接头。一旦批头夹在接头上，即可自动锁住。更换批头时只需将护套向前推，弹簧机构就会将批头从磁性中剥离并解锁，这样批头就可以很容易地拆下来了。

特别提示：即使拆卸极小的批头也可以不借助外力。带强磁性磁铁。强磁性环形磁铁的特殊设计可将又大又重的螺丝牢牢固持，是架空作业的理想工具。传动：1/4"六角，适用于DIN ISO 1173-F 6.3标准接头的电动工具。

887/4 RR 通用快速批头接杆 · 带环形磁铁



	EAN							
Code	4013288		mm			mm		
05052490001	104045	1/4"	57	2 1/4"	1/4"	16		5

887/4 RR RR 通用快速批头接杆吊卡装 · 带环形磁铁



Code	EAN							
05073511001	105790			887/4 RR	1x 1/4"x57			3

889/4/1 F Rapidaptor 插换式棘轮快速接头 · 适用于枪形手柄的定扭螺丝刀

备有于快速返还棘轮功能，作业中无需换位或取出螺丝刀。尤其适合维拉枪型定扭螺丝刀应用，拧转快速且符合人体工学原理。

独家Rapidaptor接头技术，无需推开接头衬套即可插入夹持批头。拆卸批头时，只需向前轻推衬套，即可退出批头，可单手装卸。

- 避免在旋拧操作过程中令人恼火的重新定位，用您的右手操作带枪形手柄 Wera 扭矩扳手
- 采用精密的自由运行机构，操作快速且不会产生疲劳感
- 采用免维护设计构造，超薄结构，坚固耐用的轴承，出自领先的自由运行制造商
- 最大可传输紧固扭力 10.0Nm
- 适用于符合 DIN ISO 1173-C 6.3 和 E 6.3 要求的带 1/4" 外六角驱动头的批头，以及 Wera 连接系列 1 和 4 设计

889/4/1 F Rapidaptor 插换式棘轮快速接头 · 适用于枪形手柄的定扭螺丝刀



	EAN							
Code	4013288		mm			mm		
05052501001	217585	1/4"	64	2 33/64"	1/4"	16,5		5

894/4/1 K 通用快速批头接杆

用于 DIN ISO 1173-C 6.3 标准的 1/4" 内六角批头，以及维拉系列 1 的批头。

带速拆卡盘的通用批头接杆，可牢固夹持，快速更换批头。传动：1/4" 六角，适用于 DIN ISO 1173-F 6.3 标准接头的电动工具。

894/4/1 K 通用快速批头接杆



	EAN							
Code	4013288		mm			mm		
05053522001	017512	1/4"	51	2"	1/4"	14,3		5

894/4/1 通用快速批头接杆



	EAN							
Code	4013288		mm			mm		
05053520001	017505	1/4"	75	3"	1/4"	14,3		5

895/4/1 K 通用快速批头接杆

用于 DIN ISO 1173-C 6.3 标准的 1/4" 内六角批头，以及维拉系列 1 的批头。

带强磁性磁铁和快速释放接头。传动：1/4" 六角，适用于 DIN ISO 1173-F 6.3 标准接头的电动工具。

895/4/1 K 通用快速批头接杆



	EAN							
Code	4013288		mm			mm		
05053872001	035158	1/4"	52	2"	1/4"	14,3		5

895/4/1 K 通用快速批头接杆吊卡装



	EAN							
Code	4013288							
05073318001	029195			895/4/1 K		1x 1/4"x52		3

895/4/1 通用快速批头接杆



	EAN							
Code	4013288		mm			mm		
05053870001	017574	1/4"	77	3"	1/4"	14,3		5

898/4 通用快速批头接杆

应用: 用于4mm半月形驱动 (和维拉系列9) 和4mm HIOS 驱动 (和维拉系列21) 的批头。设计: 带快速释放接头。传动: 1/4"六角, 适用于带DIN ISO 1173-F 6.3标准接头的电动工具。

898/4 通用快速批头接杆



	EAN						
Code	4013288	mm			mm		
05051500001	184177	50	2"	1/4"	10,0		5

898/9 通用快速批头接杆

应用: 用于4mm半月形驱动 (和维拉系列9) 和4mm HIOS 驱动 (和维拉系列21) 的批头。设计: 带快释放速接头。传动: 4mm半月形。

898/9 通用快速批头接杆



	EAN						
Code	4013288	mm		mm			
05051501001	184184	50	2"	10,0			5

898/21 通用快速批头接杆

应用: 用于4mm半月形驱动 (和维拉系列9) 和4mm HIOS 驱动 (和维拉系列21) 的批头。设计: 带快速释放接头。传动: 4mm HIOS。

898/21 通用快速批头接杆



	EAN						
Code	4013288	mm		mm			
05051502001	184191	50	2"	10,0			5

890/4/1 通用批头接杆

用于DIN ISO 1173-C 6.3标准的1/4"内六角批头, 以及维拉系列1的批头。传动: 1/4"六角, 适用于带DIN ISO 1173-F 6.3标准接头的电动工具。

890/4/1 通用批头接杆



	EAN							
Code	4013288		mm			mm		
05052575001	017239	1/4"	57	2 1/4"	1/4"	11,1		5

893/4/1 K 通用批头接杆

带不锈钢护套和强磁性磁铁。用于DIN ISO 1173-C 6.3标准的1/4"内六角批头, 以及维拉系列1的批头。传动: 1/4"六角, 适用于带DIN ISO 1173-F 6.3标准接头的电动工具。

893/4/1 K 通用批头接杆



	EAN							
Code	4013288		mm			mm		
05134480001	017468	1/4"	50	2"	1/4"	10,5		5

893/4/1 K 通用批头接杆吊卡装



Code	EAN				
05073401001	029133		893/4/1 K	1x 1/4"x50	3

899/3/1 通用批头接杆

带不锈钢护套和强磁性磁铁。用于DIN ISO 1173-C 6.3标准的1/4"内六角批头, 以及维拉系列1的批头。

传动: 1/4"六角, 适用于带DIN ISO 1173-F 6.3标准接头的电动工具。 传动: 5.5mm六角, 适用于带DIN ISO 1173-B 5.5标准接头的电动工具。

899/3/1 通用批头接杆



	EAN							
Code	4013288		mm		mm	mm		
05053425001	017659	1/4"	72	2 3/4"	5,5	10,5		5

899/4/1 通用批头接杆

带不锈钢护套和强磁性磁铁。用于DIN ISO 1173-C 6.3标准的1/4"内六角批头, 以及维拉系列1的批头。

传动: 1/4"六角, 适用于带DIN ISO 1173-F 6.3标准接头的电动工具。

899/4/1 通用批头接杆



	EAN							
Code	4013288	Art.No.		mm			mm	
05053457001	017673	899/4/1 K	1/4"	50	2"	1/4"	10,5	5
05053455001	017666	899/4/1 75	1/4"	75	3"	1/4"	10,5	5
05053459001	036711	899/4/1 100	1/4"	100	4"	1/4"	10,5	5
05053458001	036728	899/4/1 152	1/4"	152	6"	1/4"	10,5	5

899/4/1 通用批头接杆吊卡装



Code	EAN							
05347100001	095268			899/4/1	1x 1/4"x50			3
05073357001	029720			899/4/1	1x 1/4"x75			3
05134398001	099907			899/4/1	1x 1/4"x152			3

899/4/1 S 通用批头接杆 · 带坚固的卡环

卡环和永久性强磁性确保夹具能安全牢固地夹持批头。S=超强力。带不锈钢护套和强磁性磁铁。

用于DIN ISO 1173-C 6.3标准的1/4"内六角批头, 以及维拉系列1的批头。 传动: 1/4"六角, 适用于带DIN ISO 1173-F 6.3标准接头的电动工具。

899/4/1 S 通用批头接杆 · 带坚固的卡环



	EAN							
Code	4013288		mm			mm		
05160976001	105271	1/4"	50	2"	1/4"	10,5		5
05160924001	105264	1/4"	75	3"	1/4"	10,5		5
05160977001	105288	1/4"	100	4"	1/4"	10,5		5
05160979001	105301	1/4"	200	8"	1/4"	10,5		1
05160981001	105325	1/4"	300	12"	1/4"	10,5		1

899/14/1 通用批头接杆

传动: SDS plus四坑圆柄。

899/14/1 通用批头接杆吊卡装



Code	EAN						
05134397001	099891			899/14/1	1x 1/4"x79		3

881/4/1 SB 批头接头 · 可调式深度

在庭院施工中, 螺钉应埋入到与地板平齐的位置。881/4/1 批头接头具有可变螺钉深度限制和毡环, 可实现均匀的深度, 并保护表面不受刷痕的影响。包含两个备用毡环。

- 批头接头, 适用于庭院施工中的和盖板齐平的沉头螺钉
- 具有可调螺钉深度限制
- 毡环 (可更换) 防止地板上出现刷痕
- 包括: 2 个备用毡环

881/4/1 SB 批头接头 · 可调式深度



Code	EAN				
05130002001	4013288 219282				1
		●○	881/4/1 1x 1/4"x90 ¹⁾		
			9201 2x 27,0		

¹⁾ 可订购带有 5 个毡环的备件包, 代码为 05130003001。

9200 毡环备件包 · 用于 881/4/1 批头接头

- 881/4/1 SB 批头接头的五个备用毡环, 具有可变螺钉深度限制
- 毡环可防止地板上出现刷痕

9200 毡环备件包 · 用于 881/4/1 批头接头



Code	EAN				
05130003001	4013288 219299				1
			9201 5x 27,0		

896/4/1 SB 批头接杆 · 带可调式深度限位挡块

高质量的铝制间隔片; 螺钉安装深度可以无限地调节, 并且能够与埋头螺钉进行齐头对准;

896/4/1 SB 批头接杆 · 带可调式深度限位挡块



Code	EAN				
05073210001	4013288 178725	●○	896/4/1 1x 1/4"x50		1

870/1 转接头

应用: 用于螺帽扳手套筒。传动: 1/4"外六角。
输出: 1/4"外四角。

870/1 转接头



	EAN	□	⋄	⋄	○			
Code	4013288		mm					
05136000001 ¹⁾	016997	1/4"	25	1"	1/4"			5

¹⁾ 带摩擦球, 用于手动螺母扳手套筒

870/4 转接头

应用: 用于手动螺母扳手套筒。传动: 六角。
输出: 1/4"外四角。

870/4 转接头



	EAN	□	⋄	⋄	○			
Code	4013288		mm					
05311517001 ¹⁾	098214	1/4"	50	2"	1/4"			10
05138006001 ¹⁾	233387	1/4"	72	2"	2 53/64"			10

¹⁾ 带摩擦球, 用于手动螺母扳手套筒

870/4 转接头吊卡装



Code	EAN				
	4013288				
05134399001	099914	870/4 A	1x 1/4"x1/4"x50 ¹⁾		3
05073985001	233271	870/4 A	1x 1/4"x1/2"x72 ¹⁾		3

¹⁾ 带摩擦球，用于手动螺母扳手套筒

870/2 转接头

应用：用于螺帽扳手套筒。
输出：⁵/₁₆"外四角。

870/2 转接头



Code	EAN	□	□	□	□	□	□
	4013288		mm				
05136001001 ¹⁾	184245	3/8"	30	1 3/16"	5/16"		5
05136002001 ¹⁾	184269	1/2"	35	1 3/8"	5/16"		5

¹⁾ 带摩擦球，用于手动螺母扳手套筒

870/4 转接头

应用：用于机动螺帽扳手套筒。设计：带外四角驱动。
传动：¹/₄"六角，适用于带DIN ISO 1173-F 6.3标准接头的电动工具。

870/4 转接头



Code	EAN	□	□	□	□	□	□
	4013288		mm				
05050205001 ¹⁾	017055	1/4"	50	2"	1/4"		5
05050210001 ¹⁾	017062	1/4"	100	4"	1/4"		5
05050215001 ¹⁾	017079	3/8"	50	2"	1/4"		5
05050220001 ¹⁾	017086	3/8"	100	4"	1/4"		5

¹⁾ 带锁定销，用于机动螺母扳手套筒

870/4/7 A 组套吊卡装



Code	EAN				
	4013288				
05073200001	139115	870/4	1x 1/4"x50 ¹⁾ ; 1x 3/8"x50 ¹⁾		1
		870/7	1x 1/2"x75 ¹⁾		

¹⁾ 带锁定销，用于机动螺母扳手套筒

870/14 转接头

应用：用于机动螺帽扳手套筒。
设计：带外四角驱动。传动：SDS plus四坑圆柄。

870/14 转接头



Code	EAN	□	□	□	□	□	□
	4013288		mm				
05050650001 ¹⁾	017208	1/4"	70	2 3/4"			5

¹⁾ 带锁定销，用于机动螺母扳手套筒

870/7 转接头

应用：用于机动螺帽扳手套筒。设计：带外四角驱动。
传动：⁷/₁₆"六角，适用于带DIN ISO 1173-F 11.2标准接头的电动工具。

870/7 转接头



Code	EAN	□	□	□	□	□	□
	4013288		mm				
05050510001 ¹⁾	017178	1/2"	75	3"	7/16"		5

¹⁾ 带锁定销，用于机动螺母扳手套筒

781 A 1/4"连接部件

连接部件 1/4" 内四角套筒和 1/4" (1/2") 外四角螺丝。

用于手动和机器操作的工具 (非冲击), 配球锁, 后端滚花, 便于在手动操作时进行管理; 铬钒, 镀铬。

- 配 1/4" 内四角套筒驱动
- 含套筒固定
- 铬钒制成, 负载能力强

781 A 1/4"连接部件



Code	EAN	Art.No.	mm	mm	mm	mm	mm
05042670001	221193	781 A/B	3/8"	25,2	1"	1/4"	1
05042671001	221209	781 A/C	1/2"	36,0	1 27/64"	1/4"	1

781 B 3/8"连接部件

连接部件 3/8" 内四角套筒和 1/4" (1/2") 外四角套筒。用于手动和机器操作的工具 (非冲击), 配球锁, 后端滚花, 便于在手动操作时进行管理; 铬钒, 镀铬。

- 配 3/8" 内四角套筒驱动
- 含套筒固定
- 铬钒制成, 负载能力强

781 B 3/8"连接部件



Code	EAN	Art.No.	mm	mm	mm	mm	mm
05042672001	221247	781 B/A	1/4"	27,0	1 1/16"	3/8"	1
05042673001	221056	781 B/C	1/2"	36,0	1 27/64"	3/8"	1

781 C 1/2"连接部件

连接部件 1/2" 内四角套筒和 3/8" 外四角套筒。

用于手动和机器操作的工具 (非冲击), 配球锁, 后端滚花, 便于在手动操作时进行管理; 铬钒, 镀铬。

- 配 1/2" 内四角套筒驱动
- 含套筒固定
- 铬钒制成, 负载能力强

781 C 1/2"连接部件



Code	EAN	Art.No.	mm	mm	mm	mm	mm
05042674001	221216	781 C/B	3/8"	35,5	1 25/64"	1/2"	1

781/5 组套 1

坚固帆布吊带, 含 5 个连接部件: 781 A: 1/4" 四角内驱动, 用于 3/8" 和 1/2" 内四角套筒扳手嵌件, 配球锁; 781 B: 3/8" 四角内驱动, 用于 1/4" 和 1/2" 内四角套筒扳手嵌件, 配球锁; 781 C: 1/2" 四角内驱动, 用于 3/8" 内四角套筒扳手嵌件, 配球锁。

- 组套含 5 个连接件 (接杆), 用于内四角套筒扳手嵌件
- 含套筒固定
- 内四角套筒驱动
- 含外四角驱动
- 铬钒制成, 负载能力强

781/5 组套 1



Code	EAN	Art.No.	mm	mm	mm	mm	mm
05042680001	221223						1
		781 A	1x 781 A/B, 3/8"x25,2x1/4"; 1x 781 A/C, 1/2"x36,0x1/4"				
		781 B	1x 781 B/A, 1/4"x27,0x3/8"; 1x 781 B/C, 1/2"x36,0x3/8"				
		781 C	1x 781 C/B, 3/8"x35,5x1/2"				
		Belt 781 0/5	1x 45,0x210,0				

784 A 1/4" 快速转接头

应用: 用于DIN ISO 1173-C 6.3标准的1/4"内六角批头, 以及维拉系列1的批头。

设计: 带维拉快速释放接头。传动: 1/4"内四角。

784 A 1/4" 快速转接头



	EAN						
Code	4013288	Art.No.		mm			
05042750001	008022	784 A/1	1/4"	30	1 3/16"	1/4"	5

784 B 3/8" 快速转接头



	EAN						
Code	4013288	Art.No.		mm			
05042755001	008039	784 B/1	1/4"	43	1 5/8"	3/8"	5
05042765001	008046	784 B/2	5/16"	50	2"	3/8"	5

784 C 1/2" 快速转接头



	EAN						
Code	4013288	Art.No.		mm			
05042760001	008053	784 C/1	1/4"	50	2"	1/2"	5
05042768001	008060	784 C/2	5/16"	50	2"	1/2"	5

780 A 1/4" 转接头

用于DIN ISO 1173-C 6.3标准的1/4"内六角批头, 以及维拉系列1的批头。传动: 1/4"内四角。

780 A 1/4" 转接头



	EAN						
Code	4013288	Art.No.		mm			
05042605001	007940	780 A/1	1/4"	25	1"	1/4"	5

780 B 3/8" 转接头



	EAN						
Code	4013288	Art.No.		mm			
05042655001	007971	780 B/1	1/4"	30	1 3/16"	3/8"	5
05344511001 ¹⁾	113450	780 B/1-S	1/4"	30	1 3/16"	3/8"	5
05042665001	007988	780 B/2	5/16"	30	1 3/16"	3/8"	5
05344512001 ¹⁾	113467	780 B/2-S	5/16"	30	1 3/16"	3/8"	5

¹⁾S=超强力

780 C 1/2" 转接头



	EAN						
Code	4013288	Art.No.		mm			
05042705001	007995	780 C/1	1/4"	35	1 3/8"	1/2"	5
05344513001	113474	780 C/1-S	1/4"	35	1 3/8"	1/2"	5
05042715001	008008	780 C/2	5/16"	35	1 3/8"	1/2"	5
05344514001 ¹⁾	113481	780 C/2-S	5/16"	35	1 3/8"	1/2"	5

¹⁾S=超强力



Tool-Check PLUS

Wera

Wera
Be a Tool Pro

5.5 6 7 8 10 12 13

批头套装



抗冲击系统 – 为了极限需求而设计



超长使用寿命。对材料特性的有效利用，专为满足超常规需要而开发的特殊外形，以及特定的制造流程，这些特点成就了维拉冲击工具的超长使用寿命。冲击批头的头部涂敷了微小的金刚石颗粒，使产品更加有优势。

这些金刚石颗粒可降低滑脱影响（使用电动工具时出现几率尤高），这种滑脱可能导致螺丝头滑出。金刚石颗粒能够“咬”紧螺丝头部，这就意味着所需接触压力更小，大大延迟了电动工具螺丝拆卸作业的疲劳开始时间。带“易寻”色标系统的Bit-Checks批头套装通过颜色标识（如红色 = 十字）和尺寸标示可轻松找到所需批头。

我们希望批头更容易取出和插入，我们希望批头更轻，而新一代多重材料Bit-Check套装满足了这些要求。- Bit-Check底部区域的轻型材料保证了批头可以被牢固地保存，且易于取出。

Bit-Check 30 冲击批头套装 1



Code	EAN		
05057690001	4013288 156778		1
		<ul style="list-style-type: none"> ● 897/4 Impaktor R 1x 1/4"x75 ⊕ 851/1 IMP DC 2x PH 1x25; 3x PH 2x25; 2x PH 3x25 ⊕ 855/1 IMP DC 2x PZ 1x25; 3x PZ 2x25; 2x PZ 3x25 ⊕ 867/1 IMP DC 1x TX 10x25; 1x TX 15x25; 2x TX 20x25; 3x TX 25x25; 2x TX 30x25; 2x TX 40x25 ○ 840/1 IMP DC 1x 3,0x25; 1x 4,0x25; 1x 5,0x25; 1x 6,0x25 	

Bit-Check 30 冲击批头套装 2



Code	EAN		
05057697001	4013288 203946		1
		<ul style="list-style-type: none"> ● 897/4 Impaktor 1x 1/4"x75 ⊕ 851/1 IMP DC 2x PH 1x25; 3x PH 2x25; 2x PH 3x25 ⊕ 855/1 IMP DC 2x PZ 1x25; 3x PZ 2x25; 2x PZ 3x25 ⊕ 867/1 IMP DC 1x TX 10x25; 1x TX 15x25; 2x TX 20x25; 3x TX 25x25; 2x TX 30x25; 2x TX 40x25 ○ 840/1 IMP DC 1x 3,0x25; 1x 4,0x25; 1x 5,0x25; 1x 6,0x25 	

Bit-Check 10 冲击批头套装 1



Code	EAN		
05057680001	4013288 156785		10
		<ul style="list-style-type: none"> ● 897/4 Impaktor R 1x 1/4"x75 ⊕ 851/1 IMP DC 1x PH 2x25; 1x PH 3x25 ⊕ 855/1 IMP DC 1x PZ 2x25; 1x PZ 3x25 ⊕ 867/1 IMP DC 1x TX 20x25; 1x TX 25x25; 1x TX 30x25 ○ 840/1 IMP DC 1x 4,0x25; 1x 5,0x25 	

Bit-Check 10 冲击批头套装 1 吊卡装



Code	EAN		
05073980001	158574		1

Bit-Check 10 冲击批头套装 2



Code	EAN		
05057682001	156792		10

Bit-Check 10 冲击批头套装 3



Code	EAN		
05057683001	156761		10

Bit-Check 10 冲击批头套装 4



Code	EAN		
05057417001	180148		10

Bit-Check 10 PZ 冲击批头套装 1



Code	EAN		
05057684001	157829		10

Bit-Check 10 TX 冲击批头套装 1



Code	EAN		
05057688001	163394		10

Bit-Check 6 冲击批头套装 1



Code	EAN		
05057695001	4013288 157751		10
		+	851/4 IMP DC 1x PH 2x50; 1x PH 3x50
		+	855/4 IMP DC 1x PZ 2x50; 1x PZ 3x50
		+	867/4 IMP DC 1x TX 25x50; 1x TX 30x50

Bit-Check 6 冲击批头套装 1 吊卡装



Code	EAN		
05073890001	4013288 158635		1
		+	851/4 IMP DC 1x PH 2x50; 1x PH 3x50
		+	855/4 IMP DC 1x PZ 2x50; 1x PZ 3x50
		+	867/4 IMP DC 1x TX 25x50; 1x TX 30x50

Bit-Check 6 PH 冲击批头套装 1



Code	EAN		
05057691001	4013288 157713		20
		+	851/4 IMP DC 4x PH 2x50; 2x PH 3x50

Bit-Check 6 PZ 冲击批头套装 1



Code	EAN		
05057692001	4013288 157737		20
		+	855/4 IMP DC 4x PZ 2x50; 2x PZ 3x50

Bit-Check 6 TX 冲击批头套装 1



Code	EAN		
05057693001	4013288 157744		20
		+	867/4 IMP DC 2x TX 20x50; 2x TX 25x50; 1x TX 30x50; 1x TX 40x50

Kraftform 不锈钢系列 – 避免生锈

维拉的不锈钢工具通过真空冰处以达到所需硬度和强度，可满足工业级别的应用。

不锈钢材质避免外因锈蚀形成

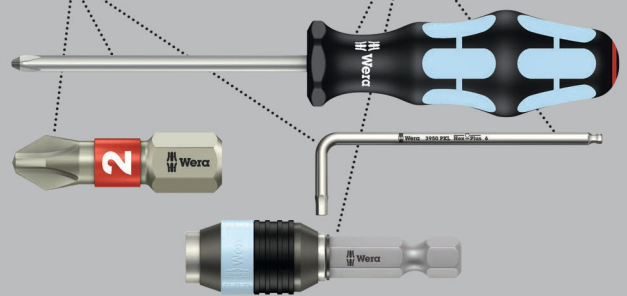

维拉不锈钢批头是由不锈钢材料制成，可有效避免锈蚀。维拉的不锈钢批头通过真空冰淬硬化以达到所需硬度和强度，可满足工业级别的应用。带“易寻”色标系统的Bit-Checks批头套装通过颜色标识（如红色 = 十字）和尺寸标示可轻松找到所需批头。

我们希望批头更容易取出和插入，我们希望批头更轻，而新一代多重材料Bit-Check套装满足了这些要求。- Bit-Check底部区域的轻型材料保证了批头可以被牢固地保存，且易于取出。

Bit-Check 30 不锈钢批头套装 1



Code	EAN		
05071109001	115126		1
		3888/4/1 K 1x 1/4"x50	
		3851/1 TS PH 1x PH 1x25; 3x PH 2x25; 1x PH 3x25	
		3855/1 TS PZ 2x PZ 1x25; 3x PZ 2x25; 1x PZ 3x25	
		3867/1 TS TORX® 2x TX 10x25; 2x TX 15x25; 3x TX 20x25; 3x TX 25x25; 2x TX 30x25; 1x TX 40x25	
		3840/1 TS 1x 2,5x25; 1x 3,0x25; 1x 4,0x25; 1x 5,0x25; 1x 5,5x25 ¹⁾	

¹⁾ 抗扭区

Bit-Check 10 不锈钢批头套装 1



Code	EAN		
05071110001	111494		10
		3888/4/1 K 1x 1/4"x50	
		3851/1 TS PH 1x PH 2x25	
		3855/1 TS PZ 1x PZ 1x25; 2x PZ 2x25	
		3867/1 TS TORX® 1x TX 10x25; 1x TX 15x25; 1x TX 20x25; 1x TX 25x25; 1x TX 30x25	

Bit-Check 10 不锈钢批头套装 1 吊卡装



Code	EAN		
05073630001	112163		1
		3888/4/1 K 1x 1/4"x50	
		3851/1 TS PH 1x PH 2x25	
		3855/1 TS PZ 1x PZ 1x25; 2x PZ 2x25	
		3867/1 TS TORX® 1x TX 10x25; 1x TX 15x25; 1x TX 20x25; 1x TX 25x25; 1x TX 30x25	

Bit-Check 6 不锈钢批头套装 1 吊卡装

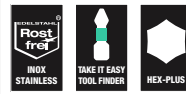

Code	EAN		
05073634001	164636		1
		3855/4 2x PZ 2x50	
		3867/4 TORX® 1x TX 20x50; 2x TX 25x50	
		3840/4 Hex-Plus 1x 5.5x50	



双重抗扭系统 – 给您更长的应用周期

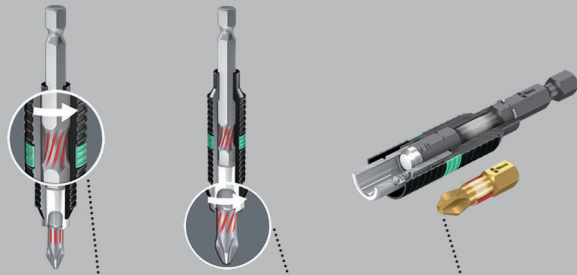

双重抗扭设计 接杆吸收一小部分扭力

大部分的扭力会被批头上标示的双重抗扭区吸收

正常使用下的扭力冲击，并不会造成不必要的磨损

Bit-Safe 61 双重抗扭批头套装 1

新型的Bit-Safes批头套装为用户提供了各种批头和夹具产品，并存放在紧凑的、具有保护表面功能的织布包装中。1个快速批头接杆。

60个双重抗扭批头，使用寿命长，金刚石涂层（BDC）不易打滑，具有韧性（BTZ），通用型，硬度更高（BTH）。

带“易寻”色标系统的Bit-Safes批头套装通过颜色和尺寸标示可轻松找到所需批头。

Bit-Safe 61 双重抗扭批头套装 1



Code	EAN			
	4013288			
05057441001	179937			1
			889/4/1 K 1x 1/4"x50	
			851/1 BDC PH 1x PH 1x25; 2x PH 2x25; 1x PH 3x25	
			851/1 BTZ PH 2x PH 1x25; 8x PH 2x25; 1x PH 3x25	
			855/1 BDC PZ 1x PZ 1x25; 2x PZ 2x25; 1x PZ 3x25	
			855/1 BTH PZ 2x PZ 1x25; 8x PZ 2x25; 1x PZ 3x25	
			867/1 TORX® BTZ 3x TX 10x25; 2x TX 15x25; 4x TX 20x25; 4x TX 25x25; 2x TX 30x25; 1x TX 40x25	
			800/1 BDC 1x 0,8x5,5x25; 1x 1,0x5,5x25; 1x 1,2x6,5x25	
			840/1 BTZ Hex-Plus 3x 2,5x25; 3x 3,0x25; 3x 4,0x25; 2x 5,0x25	
			C魔术贴 120 1x 50,0x120,0	

Bit-Checks 双重抗扭批头套装

批头坚固且韧性强, 适合通用型应用。BiTorsion 双重抗扭批头, 带扭力区 - 可在峰值负荷状态下分散动能。由此极大延长了产品使用寿命。

实现较长使用寿命, 配有固持器。采用 Rapidaptor 技术, 无需致动套筒即可连接批头。批头拆卸轻松简便, 仅需将套筒向前推——单手即可快速更换批头。

适用于安装符合 DIN ISO 1173-C 6.3 和 E 6.3 的带 1/4" 六角刀头的批头。可装入电动螺丝刀或电钻夹头。多组件 Bit-Check 得益于其重量轻和最大程度紧凑式设计,

性能可靠。在这方面, Bit-Check 下部的软质材料确保批头稳固夹持, 同时易于取出。

通过 Wera“Take it easy”工具查找装置, 其中自带颜色编码和清晰可辨的标识, 可轻松识别批头的型面和尺寸。

Bit-Check 30 双重抗扭批头套装 1



Code	EAN			
05057430001	4013288 179821			1
		●○	889/4/1 K 1x 1/4"x50	
		+	851/1 BTZ PH 2x PH 1x25; 5x PH 2x25; 2x PH 3x25	
		+	855/1 BTZ PZ 2x PZ 1x25; 6x PZ 2x25; 2x PZ 3x25	
		✳	867/1 TORX® BTZ 1x TX 10x25; 2x TX 15x25; 2x TX 20x25; 2x TX 25x25; 2x TX 30x25; 1x TX 40x25	

Bit-Check 12 双重抗扭批头套装 1



Code	EAN			
05057420001	4013288 179869			10
		●○	889/4/1 K 1x 1/4"x50	
		+	851/1 BTZ PH 1x PH 1x25; 2x PH 2x25	
		+	855/1 BTZ PZ 1x PZ 1x25; 2x PZ 2x25	
		✳	867/1 TORX® BTZ 1x TX 10x25; 1x TX 15x25; 1x TX 20x25; 1x TX 25x25; 1x TX 30x25	

Bit-Check 12 BiTorsion 1 SB



Code	EAN			
05136385001	4013288 213969			1
		●○	889/4/1 K 1x 1/4"x50	
		+	851/1 BTZ PH 1x PH 1x25; 2x PH 2x25	
		+	855/1 BTZ PZ 1x PZ 1x25; 2x PZ 2x25	
		✳	867/1 TORX® BTZ 1x TX 10x25; 1x TX 15x25; 1x TX 20x25; 1x TX 25x25; 1x TX 30x25	



Bit-Check 10 双重抗扭批头套装 1



Code	EAN		
05056374001	4013288 095688		10
		● 897/4 R 1x 1/4"x75	
		⊕ 851/1 BTZ PH 1x PH 1x25; 1x PH 2x25; 1x PH 3x25	
		⊕ 855/1 BTZ PZ 1x PZ 1x25; 1x PZ 2x25; 1x PZ 3x25	
		⊖ 800/1 BTZ 1x 0,8x5,5x25; 1x 1,0x5,5x25; 1x 1,2x6,5x25	

Bit-Check 10 双重抗扭批头套装吊卡装 3



Code	EAN		
05073418001	4013288 128157		1
		● 897/4 R 1x 1/4"x75	
		⊕ 851/1 BTZ PH 1x PH 2x25	
		⊕ 855/1 BTZ PZ 1x PZ 1x25 1x PZ 2x25 1x PZ 3x25	
		⊕ 867/1 TORX® BTZ 1x TX 10x25; 1x TX 15x25; 1x TX 20x25; 1x TX 25x25; 1x TX 30x25	

Bit-Check 10 PZ 双重抗扭批头套装 2

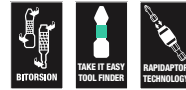

Code	EAN		
05347153001	4013288 107152		10
		● 897/4 R 1x 1/4"x75	
		⊕ 855/1 BTH PZ 1x PZ 1x25; 7x PZ 2x25; 1x PZ 3x25	

金刚石涂层批头

分布在批头尖端的超微金刚石粉末 实实在在的咬合力

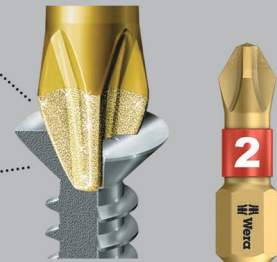

批头和螺丝凹槽稳固的贴合

金刚石涂层批头的头部涂敷了微小的金刚石颗粒，能够“咬”紧螺丝头部，有效地降低了操作时滑脱的危险。同时，操作时保持在螺丝上的压力需求也大大降低。

使用电动工具时，在启动的瞬间或螺丝旋到限位停止的瞬间产生的峰值冲击力会导致批头崩坏或螺丝头的损坏。

如果可以让这种峰值负载的影响充分降低，螺丝拆装作业就会更高效、更安全。

维拉的双重抗扭批头实现了这个设想，使工具的寿命和生产效率都得到了显著提高。我们希望批头更容易取出和插入，我们希望批头更轻，而新一代多重材料Bit-Check套装满足了这些要求。Bit-Check底部区域的轻型材料保证了批头可以被牢固地保存，且易于取出。

Bit-Check 30 金刚石涂层批头套装 1



Code	EAN			
	4013288			
05057431001	179814			1
			889/4/1 K 1x 1/4"x50	
			851/1 BDC PH 2x PH 1x25; 4x PH 2x25; 1x PH 3x25	
			855/1 BDC PZ 2x PZ 1x25; 4x PZ 2x25; 1x PZ 3x25	
			867/1 TORX® BDC 2x TX 10x25; 2x TX 15x25; 3x TX 20x25; 3x TX 25x25; 1x TX 30x25; 1x TX 40x25	
			800/1 BDC 1x 0,8x5,5x25; 1x 1,0x5,5x25; 1x 1,2x6,5x25	

Bit-Check 12 金刚石涂层批头套装 1



Code	EAN			
	4013288			
05057421001	180025			10
			889/4/1 K 1x 1/4"x50	
			851/1 BDC PH 1x PH 1x25; 2x PH 2x25	
			855/1 BDC PZ 1x PZ 1x25; 2x PZ 2x25	
			867/1 TORX® BDC 1x TX 10x25; 1x TX 15x25; 1x TX 20x25; 1x TX 25x25; 1x TX 30x25	

Bit-Check 12 Diamond 1 SB



Code	EAN			
	4013288			
05136392001	213976		889/4/1 K 1x 1/4"x50	1
			851/1 BDC PH 1x PH 1x25; 2x PH 2x25	
			855/1 BDC PZ 1x PZ 1x25; 2x PZ 2x25	
			867/1 TORX® BDC 1x TX 10x25; 1x TX 15x25; 1x TX 20x25; 1x TX 25x25; 1x TX 30x25	

Bit-Check 7 金刚石涂层批头套装 1



Code	EAN			
	4013288			
05057416001	179999			10
			889/4/1 K 1x 1/4"x50	
			851/1 BDC PH 1x PH 1x25; 1x PH 2x25	
			855/1 BDC PZ 1x PZ 1x25; 1x PZ 2x25	
			800/1 BDC 1x 1,0x5,5x25; 1x 1,2x6,5x25	



Bit-Check 7 金刚石涂层批头套装 1 吊卡装

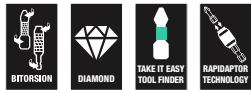

Code	EAN		
05073419001	183682	889/4/1 K 1x 1/4"x50	1
		851/1 BDC PH 1x PH 1x25; 1x PH 2x25	
		855/1 BDC PZ 1x PZ 1x25; 1x PZ 2x25	
		800/1 BDC 1x 1.0x5.5x25; 1x 1.2x6.5x25	

Bit-Check 7 PZ 金刚石涂层批头套装 1



Code	EAN		
05057412001	180001	889/4/1 K 1x 1/4"x50	10
		855/1 BDC PZ 2x PZ 1x25; 3x PZ 2x25; 1x PZ 3x25	

Bit-Check 7 TX 金刚石涂层批头套装 1



Code	EAN		
05057415001	180018	889/4/1 K 1x 1/4"x50	10
		867/1 TORX® BDC 1x TX 10x25; 1x TX 15x25; 1x TX 20x25; 1x TX 25x25; 1x TX 30x25; 1x TX 40x25	

帆布包



Bit-Safe 61 通用型批头套装 1

新型的Bit-Safes批头套装为用户提供了各种批头和夹具产品，并存放在紧凑的、具有保护表面功能的帆布包装中。1个快速批头接杆，带强磁性磁铁。60个批头，抗扭设计 (T) 防止过早崩坏，耐用 (Z)，通用型。带环形磁铁。无需移动护套即可将批头推入接头。一旦批头夹在接头上，即可自动锁住。

更换批头时只需将护套向前推，弹簧机构就会将批头从磁性中剥离并解锁，这样批头就可以很容易地拆下来了。特别提示：即使拆卸极小的批头也可以不借助外力。可用于DIN ISO 1173-C 6,3和E 6,3标准的1/4"驱动批头，以及维拉系列1和4的批头。

Bit-Safe 61 通用型批头套装 1



Code	EAN			
05057122001	4013288 100689			1
		●○	889/4/1 K 1x 1/4"x50	
		+	851/1 TZ 3x PH 1x25; 10x PH 2x25; 2x PH 3x25	
		+	855/1 TZ 3x PZ 1x25; 10x PZ 2x25; 2x PZ 3x25	
		⊕	867/1 TZ TORX® 2x TX 10x25; 3x TX 15x25; 3x TX 20x25; 3x TX 25x25; 3x TX 30x25; 2x TX 40x25	
		⊖	800/1 TZ 1x 0,6x4,5x25; 1x 1,0x5,5x25; 1x 1,2x6,5x25	
		○	840/1 Z 3x 2,5x25; 3x 3,0x25; 3x 4,0x25; 2x 5,0x25	
			魔术贴 120 1x 50,0x120,0	

Bit-Safe 43 通用型批头套装 1

1个通用批头接杆, 带不锈钢护套、卡环和强磁性磁铁。42个批头, 抗扭设计 (T) 防止过早崩坏, 耐用 (Z), 通用型。带卡环的通用夹具。

卡环和永久性强磁性确保夹具能安全牢固地夹持批头。

Bit-Safe 43 通用型批头套装 1



Code	EAN			
05057450001	4013288 179951			1
		●○	899/4/1 1x 1/4"x50	
		+	851/1 Z 1x PH 2x25	
		+	851/4 TZ 1x PH 1x50; 2x PH 2x50	
		+	855/1 Z 2x PZ 1x25; 5x PZ 2x25; 2x PZ 3x25	
		+	855/4 TZ 1x PZ 1x50; 2x PZ 2x50	
		⊕	867/1 TORX® 3x TX 10x25; 4x TX 15x25; 4x TX 20x25; 4x TX 25x25; 4x TX 30x25; 1x TX 40x25	
		⊕	867/4 Z TORX® 1x TX 10x50; 1x TX 15x50; 1x TX 20x50; 1x TX 25x50; 1x TX 30x50; 1x TX 40x50	
			魔术贴 120 1x 50,0x120,0	



Bit-Check 30 通用型批头套装 1

1个快速批头接杆。29个批头，抗扭设计 (T) 防止过早崩坏，耐用 (Z)，通用型，硬度更高 (H)。快速接杆。无需任何工具，单手即可快速更换批头。单手操作自由旋转护套，使得作业启动时螺丝保持稳定，是架空作业时的理想工具。

Bit-Check 30 通用型批头套装 1



Code	EAN		
05056440001	115096		1
		889/4/1 K 1x 1/4"x50	
		851/1 TZ PH 2x PH 1x25; 3x PH 2x25; 1x PH 3x25	
		855/1 TH PZ 2x PZ 1x25; 3x PZ 2x25; 1x PZ 3x25	
		867/1 TZ TORX® 1x TX 10x25; 1x TX 15x25; 1x TX 20x25; 1x TX 25x25; 1x TX 30x25; 1x TX 40x25	
		867/1 Z TORX® B0 1x TX 10x25; 1x TX 15x25; 1x TX 20x25; 1x TX 25x25; 1x TX 30x25	
		800/1 TZ 1x 1,0x5,5x25	
		840/1 Z Hex-Plus 1x 3,0x25; 1x 4,0x25; 1x 5,0x25; 1x 6,0x25; 1x 8,0x25	

Bit-Check 30 TX 通用型批头套装 1

1个通用批头接杆，带不锈钢护套、卡环和强磁性磁铁。29个批头，耐用，通用型。带卡环的通用夹具 899/4/1 K。卡环和永久性强磁性确保夹具能安全牢固地夹持批头。维拉设计的缓冲吸收型批头能避免批头头部的早期断裂。该批头可通过产品目录中的产品字母Z来识别。

Bit-Check 30 TX 通用型批头套装 1



Code	EAN		
05057908001	163820		10
		899/4/1 1x 1/4"x50	
		867/1 TORX® 3x TX 10x25; 5x TX 15x25; 8x TX 20x25; 7x TX 25x25; 4x TX 30x25; 2x TX 40x25	

Bit-Check 30 TX 通用型 1 SB



Code	EAN		
05057900001	229618		1
		899/4/1 1x 1/4"x50	
		867/1 TORX® 3x TX 10x25; 5x TX 15x25; 8x TX 20x25; 7x TX 25x25; 4x TX 30x25; 2x TX 40x25	

Bit-Check 10 通用型批头套装 1

- 坚固而具有韧性的通用批头
- 通用快速夹具, 可快速更换批头

Bit-Check 10 通用型批头套装 1



Code	EAN		
05056161001	4013288 033772		10
		●○ 895/4/1 K 1x 1/4"x52	
		⊕ 851/1 TZ PH 1x PH 1x25; 1x PH 2x25; 1x PH 3x25	
		⊕ 855/1 TZ PZ 1x PZ 1x25; 1x PZ 2x25; 1x PZ 3x25	
		⊖ 800/1 TZ 1x 0,8x5,5x25; 1x 1,0x5,5x25; 1x 1,2x6,5x25	

Bit-Check 10 通用型批头套装 2

- 超硬批头
- 抗扭设计, 避免早期磨损
- 通用快速夹具, 带强磁性磁铁

Bit-Check 10 通用型批头套装 2



Code	EAN		
05134200001	4013288 038821		10
		●○ 895/4/1 K 1x 1/4"x52	
		⊕ 855/1 TH PZ 1x PZ 1x25; 2x PZ 2x25	
		⊕ 867/1 TORX® 1x TX 10x25; 1x TX 15x25; 1x TX 20x25; 1x TX 25x25; 1x TX 30x25; 1x TX 40x25	

Bit-Check 10 通用型批头套装 3

- 坚固而具有韧性的通用批头
- 快速接杆可快速更换批头

Bit-Check 10 通用型批头套装 3



Code	EAN		
05056375001	4013288 095695		10
		●○ 889/4/1 K 1x 1/4"x50	
		⊕ 851/1 TZ PH 1x PH 1x25; 1x PH 2x25; 1x PH 3x25	
		⊕ 855/1 TZ PZ 1x PZ 1x25; 1x PZ 2x25; 1x PZ 3x25	
		⊖ 800/1 TZ 1x 0,8x5,5x25; 1x 1,0x5,5x25; 1x 1,2x6,5x25	

Bit-Check 10 通用型批头套装 3 吊卡装



Code	EAN		
05073410001	4013288 099495		1
		●○ 889/4/1 K 1x 1/4"x50	
		⊖ 800/1 TZ 1x 0,8x5,5x25; 1x 1,0x5,5x25; 1x 1,2x6,5x25	
		⊕ 851/1 TZ PH 1x PH 1x25; 1x PH 2x25; 1x PH 3x25	
		⊕ 855/1 TZ PZ 1x PZ 1x25; 1x PZ 2x25; 1x PZ 3x25	



Bit-Check 10 通用型批头套装 4

- 坚固而具有韧性的通用批头
- 通用夹具，带不锈钢护套、卡环和强磁性磁铁

Bit-Check 10 通用型批头套装 4



Code	EAN		
05056159001	4013288 033758		10
		● 899/4/1 1x 1/4"x50	
		⊕ 851/1 TZ PH 1x PH 1x25; 1x PH 2x25; 1x PH 3x25	
		⊕ 855/1 TZ PZ 1x PZ 1x25; 1x PZ 2x25; 1x PZ 3x25	
		⊖ 800/1 TZ 1x 0,8x5,5x25; 1x 1,0x5,5x25; 1x 1,2x6,5x25	

Bit-Check 10 通用型批头套装 5 吊卡装

- 坚固而具有韧性的通用批头
- 内含通用夹具，用于 1/4"六角头驱动的批头夹具

Bit-Check 10 通用型批头套装 5 吊卡装



Code	EAN		
05073416001	4013288 128164		1
		● 899/4/1 1x 1/4"x50	
		⊕ 851/1 Z PH 1x PH 2x25	
		⊕ 855/1 Z PZ 1x PZ 1x25; 1x PZ 2x25; 1x PZ 3x25	
		⊕ 867/1 TORX® 1x TX 10x25; 1x TX 15x25; 1x TX 20x25; 1x TX 25x25; 1x TX 30x25	

Bit-Check 10 TX 通用型批头套装 1

- 坚固而具有韧性的通用批头
- 抗扭设计，避免早期磨损
- 通用快速夹具，可快速更换批头

Bit-Check 10 TX 通用型批头套装 1



Code	EAN		
05056164001	4013288 033802		10
		● 894/4/1 K 1x 1/4"x51	
		⊕ 867/1 TZ TORX® 1x TX 8x25; 1x TX 9x25; 1x TX 10x25; 1x TX 15x25; 1x TX 20x25; 1x TX 25x25; 1x TX 27x25; 1x TX 30x25; 1x TX 40x25	

Bit-Check 10 TX 通用型批头套装 2

- 坚固而具有韧性的通用批头
- 快速接杆可快速更换批头

Bit-Check 10 TX 通用型批头套装 2



Code	EAN		
05057115001	4013288 127747		10
		● 888/4/1 K 1x 1/4"x50	
		⊕ 867/1 TORX® 1x TX 6x25; 1x TX 8x25; 1x TX 9x25; 1x TX 10x25; 1x TX 15x25; 1x TX 20x25; 1x TX 25x25; 1x TX 30x25; 1x TX 40x25	

Bit-Check 7 通用型批头套装 1

- 坚固而具有韧性的通用批头
- 通用夹具, 带不锈钢护套和强磁性磁铁

Bit-Check 7 通用型批头套装 1



Code	EAN		
	4013288		
05056295001	038166		20
		893/4/1 K 1x 1/4"x50	
		851/1 Z PH 1x PH 1x25; 1x PH 2x25	
		855/1 Z PZ 1x PZ 1x25; 1x PZ 2x25	
		800/1 Z 1x 1,0x5,5x25; 1x 1,2x6,5x25	

Bit-Check 7 通用型批头套装 1 吊卡装



Code	EAN		
	4013288		
05073406001	036186		1
		893/4/1 K 1x 1/4"x50	
		851/1 Z PH 1x PH 1x25; 1x PH 2x25	
		855/1 Z PZ 1x PZ 1x25; 1x PZ 2x25	
		800/1 Z 1x 1.0x5.5x25; 1x 1.2x6.5x25	

Bit-Check 7 通用型批头套装 4



Code	EAN		
	4013288		
05135810001	179265		20
		893/4/1 K 1x 1/4"x50	
		851/1 Z PH 1x PH 2x25	
		855/1 Z PZ 1x PZ 1x25; 1x PZ 2x25	
		867/1 TORX® 1x TX 15x25; 1x TX 20x25; 1x TX 25x25	

Bit-Check 7 PZ 通用型批头套装 1



Code	EAN		
	4013288		
05056296001	038135		20
		893/4/1 K 1x 1/4"x50	
		855/1 Z PZ 2x PZ 1x25; 3x PZ 2x25; 1x PZ 3x25	



Bit-Check 7 TX 通用型批头套装 1

- 坚固而具有韧性的通用批头
- 通用夹具, 带不锈钢护套和强磁性磁铁

Bit-Check 7 TX 通用型批头套装 1



Code	EAN		
05056294001	4013288 041500		20
		●● 893/4/1 K 1x 1/4"x50	
		♻️ 867/1 TORX® 1x TX 10x25; 1x TX 15x25; 1x TX 20x25; 1x TX 25x25; 1x TX 30x25; 1x TX 40x25	

Bit-Check 7 TX 通用型批头套装吊卡装 1



Code	EAN		
05073404001	4013288 038111		1
		●● 893/4/1 K 1x 1/4"x50	
		♻️ 867/1 TORX® 1x TX 10x25; 1x TX 15x25; 1x TX 20x25; 1x TX 25x25; 1x TX 30x25; 1x TX 40x25	

Bit-Check 7 TX B0 通用型批头套装 1

- 坚固而具有韧性的通用批头
- 通用快速夹具, 可快速更换批头

Bit-Check 7 TX B0 通用型批头套装 1



Code	EAN		
05056158001	4013288 033741		20
		●● 894/4/1 K 1x 1/4"x51	
		♻️ 867/1 Z TORX® B0 1x TX 10x25; 1x TX 15x25; 1x TX 20x25; 1x TX 25x25; 1x TX 30x25; 1x TX 40x25	

增强型内六角- 专门针对六角型螺丝的设计

如图可看到和螺槽的接触面积大幅度的增加 因此减少了
转动时各个面所承受的压力

从而避免破坏螺丝凹槽的轮廓

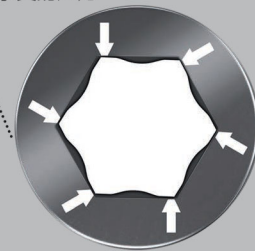

Bit-Check 7 Hex-Plus 通用型批头套装 1



Code	EAN		
05056168001	4013288 033840		20
		●● 895/4/1 K 1x 1/4"x52	
		● 840/1 Z Hex-Plus 1x 2,0x25; 1x 2,5x25; 1x 3,0x25; 1x 4,0x25; 1x 5,0x25; 1x 6,0x25	

Bit-Check 6 通用型批头套装 1

- 坚固而具有韧性的通用批头
- 抗扭设计可吸收峰值载荷
- 防止驱动端的早期断裂

Bit-Check 6 通用型批头套装 1



Code	EAN		
05056474001	4013288 156143		20
		+	851/4 TZ PH 1x PH 1x50; 1x PH 2x50
		+	855/4 TZ PZ 1x PZ 1x50; 1x PZ 2x50
		●	800/4 Z 1x 1,0x5,5x50; 1x 1,2x6,5x50

Bit-Check 6 通用型批头套装 1 吊卡装



Code	EAN		
05073635001	4013288 155276		1
		+	851/4 TZ PH 1x PH 1x50; 1x PH 2x50
		+	855/4 TZ PZ 1x PZ 1x50; 1x PZ 2x50
		●	800/4 Z 1x 1,0x5,5x50; 1x 1,2x6,5x50

Bit-Check 6 通用型批头套装 2



Code	EAN		
05056473001	4013288 156136		20
		+	851/4 TZ PH 1x PH 2x50
		+	855/4 TZ PZ 1x PZ 1x50; 1x PZ 2x50
		●	867/4 Z TORX® 1x TX 15x50; 1x TX 20x50; 1x TX 25x50

Bit-Check 6 通用型批头套装 2 吊卡装



Code	EAN		
05073638001	4013288 155245		1
		+	851/4 TZ PH 1x PH 2x50
		+	855/4 TZ PZ 1x PZ 1x50; 1x PZ 2x50
		●	867/4 Z TORX® 1x TX 15x50; 1x TX 20x50; 1x TX 25x50



Bit-Check 6 TX 通用型批头套装 1

- 坚固而具有韧性的通用批头

Bit-Check 6 TX 通用型批头套装 1



Code	EAN		
	4013288		
05056472001	156112		20
		867/4 Z TORX® 1x TX 10x50; 1x TX 15x50; 1x TX 20x50; 1x TX 25x50; 1x TX 30x50; 1x TX 40x50	

Bit-Check 6 TX 通用型批头套装 1 吊卡装



Code	EAN		
	4013288		
05073637001	155252	867/4 Z TORX® 1x TX 10x50; 1x TX 15x50; 1x TX 20x50; 1x TX 25x50; 1x TX 30x50; 1x TX 40x50	1

Bit-Check 6 PZ 通用型批头套装 1

6个批头, 抗扭设计 (T) 防止过早崩坏, 耐用 (Z), 通用型。Bit-Checks批头套装可以直立放置在工作场所, 便于取用。

Bit-Check 6 PZ 通用型批头套装 1



Code	EAN		
	4013288		
05056471001	156105		20
		855/4 TZ PZ 2x PZ 1x50; 3x PZ 2x50; 1x PZ 3x50	

Bit-Check 6 V 通用型批头套装 1

6个批头, 耐用 (Z), 通用型, 带固持功能。V系列批头在驱动头的位置采用小角度的锥形, 能够和内四方螺丝紧密的接合, 适用于螺丝定位有困难的情况。

维拉设计的缓冲吸收型批头能避免批头头部的早期断裂。

该批头可通过产品目录中的产品字母Z来识别。
1/4"六角, 适用于DIN ISO 1173-F 6.3标准的批头接头。

Bit-Check 6 V 通用型批头套装 1



Code	EAN		
	4013288		
05056478001	190802		10
		868/4 V 1x # 1x50; 3x # 2x50; 2x # 3x50	

Bit-Check 30 Wood TX HF 1

特别适用于木材加工的批头和固持器组套。

867/1 TORX® HF 批头采用了特殊几何结构,符合 Acument Intellectual Properties 规格,可将 TORX® 螺丝稳定地固定在工具上!该批头适用于难以触及、不方便用另一只手握住螺丝的工作区域。另外,此类批头还适用于 Würth ASSY 螺丝以及 Altenloh SPAX T-STAR plus 螺丝。

配Take it easy易寻色标系统:用特定颜色代表不同尺寸。

Rapidaptor 固持器可实现超快速更换。

Bit-Check 可快速地简要了解所提供的工具。未使用的套头只需简单地放回固定器,且不会丢失。

易于运输,例如可放在上衣插袋内。Bit-Check 可以安放在工作区,这样可方便快速取用工具。

- TORX®梅花螺丝固持功能
- 另外,还适用于 Würth ASSY 螺丝以及 Altenloh SPAX T-STAR plus 螺丝

Bit-Check 30 Wood TX HF 1



Code	EAN		
05057436001	4013288 226204		10
		●● 887/4 RR 1x 1/4"x57	
		⊕ 851/1 TZ 2x PH 2x25; 1x PH 3x25	
		⊕ 855/1 TH 3x PZ 1x25; 6x PZ 2x25; 2x PZ 3x25	
		⊕ 867/1 TORX® HF 2x TX 10x25; 2x TX 15x25; 4x TX 20x25; 4x TX 25x25; 2x TX 30x25; 1x TX 40x25 ¹⁾	

¹⁾ Pound-thru 六角; 无Take it easy易寻色标系统。

Bit-Check 30 Wood TX HF 1 SB



Code	EAN		
05057437001	4013288 227522		1
1x Bit-Check 30 Wood TX HF 1			
		●● 887/4 RR 1x 1/4"x57	
		⊕ 851/1 TZ 2x PH 2x25; 1x PH 3x25	
		⊕ 855/1 TH 3x PZ 1x25; 6x PZ 2x25; 2x PZ 3x25	
		⊕ 867/1 TORX® HF 2x TX 10x25; 2x TX 15x25; 4x TX 20x25; 4x TX 25x25; 2x TX 30x25; 1x TX 40x25 ¹⁾	

¹⁾ Pound-thru 六角; 无Take it easy易寻色标系统。

Bit-Check 30 木质工件专用批头套装 1

- 夹具带Rapidaptor技术,带环形磁铁,可夹持更长更重的螺丝

Bit-Check 30 木质工件专用批头套装 1



Code	EAN		
05057433001	4013288 179807		1
		●● 887/4 RR 1x 1/4"x57	
		⊕ 851/1 TZ PH 2x PH 2x25; 1x PH 3x25	
		⊕ 855/1 TH PZ 3x PZ 1x25; 6x PZ 2x25; 2x PZ 3x25	
		⊕ 867/1 TZ TORX® 2x TX 10x25; 2x TX 15x25; 4x TX 20x25; 4x TX 25x25; 2x TX 30x25; 1x TX 40x25	

Bit-Check 30 木质工件专用批头套装 2

- 通用夹具, 带不锈钢护套

Bit-Check 30 木质工件专用批头套装 2



Code	EAN		
05057432001	4013288 179845		10
		● 899/4/1 1x 1/4"x50	
		⊕ 851/1 Z PH 1x PH 2x25	
		⊕ 855/1 Z PZ 2x PZ 1x25; 5x PZ 2x25; 2x PZ 3x25	
		⊕ 867/1 TORX® 3x TX 10x25; 4x TX 15x25; 4x TX 20x25; 4x TX 25x25; 3x TX 30x25; 1x TX 40x25	

Bit-Check 30 Wood 2 SB



Code	EAN		
05057438001	4013288 229625		1
		● 899/4/1 1x 1/4"x50	
		⊕ 851/1 Z 1x PH 2x25	
		⊕ 855/1 Z 2x PZ 1x25; 5x PZ 2x25; 2x PZ 3x25	
		⊕ 867/1 TORX® 3x TX 10x25; 4x TX 15x25; 4x TX 20x25; 4x TX 25x25; 3x TX 30x25; 1x TX 40x25	

Bit-Check 12 Wood TX HF 1

特别适用于木材加工的批头和固持器组套。

867/1 TORX® HF 批头采用了特殊几何结构, 符合 Acument Intellectual Properties 规格, 可将 TORX® 螺丝稳定地固定在工具上! 该批头适用于难以触及、不方便用另一只手握住螺丝的工作区域。另外, 此类批头还适用于 Würth ASSY 螺丝以及 Altenloh SPAX T-STAR plus 螺丝。

配Take it easy易寻色标系统: 用特定颜色代表不同尺寸。

带环形磁铁的 Rapidaptor 固持工具, 用于固持质量较大的长螺丝。

Bit-Check 可快速地简要了解所提供的工具。未使用的套头只需简单地放回固定器, 且不会丢失。

易于运输, 例如可放在上衣插袋内。Bit-Check 可以安放在工作区, 这样可方便快速取用工具。

- 带固持功能、适用于符合 Acument Intellectual Properties 规格的 TORX® 螺丝的 867/1 TORX® HF 批头
- 另外, 还适用于 Würth ASSY 螺丝以及 Altenloh SPAX T-STAR plus 螺丝

Bit-Check 12 Wood TX HF 1



Code	EAN		
05057435001	4013288 226198		10
		● 887/4 RR 1x 1/4"x57	
		⊕ 855/1 Z 1x PZ 1x25; 1x PZ 2x25	
		⊕ 867/1 TORX® HF 1x TX 10x25; 1x TX 15x25; 1x TX 20x25; 2x TX 25x25; 1x TX 30x25; 1x TX 40x25 ¹⁾	
		⊕ 867/1 TORX® 1x TX 20x25; 1x TX 25x25	

¹⁾ Pound-thru 六角; 无Take it easy易寻色标系统。

Bit-Check 12 Wood TX HF 1 SB



Code	EAN		
05073641001	4013288 227515		1
1x Bit-Check 12 Wood TX HF 1			
		●○ 887/4 RR 1x 1/4"x57	
		⊕ 855/1 Z 1x PZ 1x25; 1x PZ 2x25	
		⊕ 867/1 TORX® HF 1x TX 10x25; 1x TX 15x25; 1x TX 20x25; 2x TX 25x25; 1x TX 30x25; 1x TX 40x25 ¹⁾	
		⊕ 867/1 TORX® 1x TX 20x25; 1x TX 25x25	

¹⁾ Pound-thru 六角; 无Take it easy易寻色标系统。

Bit-Check 12 木质工件专用批头套装 1

- 夹具带Rapidaptor技术, 带环形磁铁, 可夹持更长更重的螺丝

Bit-Check 12 木质工件专用批头套装 1



Code	EAN		
05057423001	4013288 179876		10
		●○ 887/4 RR 1x 1/4"x57	
		⊕ 855/1 TH PZ 1x PZ 1x25; 2x PZ 2x25; 1x PZ 3x25	
		⊕ 851/1 TH PH 1x PH 2x25	
		⊕ 867/1 TORX® 1x TX 10x25; 1x TX 15x25; 1x TX 20x25; 1x TX 25x25; 1x TX 30x25; 1x TX 40x25	

Bit-Check 12 Wood 1 SB



Code	EAN		
05136390001	4013288 214010		1
		●○ 887/4 RR 1x 1/4"x57	
		⊕ 851/1 TH PH 1x PH 2x25	
		⊕ 855/1 TH PZ 1x PZ 1x25; 2x PZ 2x25; 1x PZ 3x25	
		⊕ 867/1 TORX® 1x TX 10x25; 1x TX 15x25; 1x TX 20x25; 1x TX 25x25; 1x TX 30x25; 1x TX 40x25	

Bit-Check 12 木质工件专用批头套装 2

- 通用夹具, 带不锈钢护套

Bit-Check 12 木质工件专用批头套装 2



Code	EAN		
05057422001	4013288 179890		10
		●○ 899/4/1 1x 1/4"x50	
		⊕ 851/1 Z PH 1x PH 2x25	
		⊕ 855/1 Z PZ 1x PZ 1x25; 2x PZ 2x25; 1x PZ 3x25	
		⊕ 867/1 TORX® 1x TX 10x25; 1x TX 15x25; 1x TX 20x25; 1x TX 25x25; 1x TX 30x25; 1x TX 40x25	



Bit-Check 12 Wood 2 SB



Code	EAN			
05136391001	214027		899/4/1 1x 1/4"x50	1
			851/1 Z PH 1x PH 2x25	
			855/1 Z PZ 1x PZ 1x25; 2x PZ 2x25; 1x PZ 3x25	
			867/1 TORX® 1x TX 10x25; 1x TX 15x25; 1x TX 20x25; 1x TX 25x25; 1x TX 30x25; 1x TX 40x25	

Bit-Check 6 Wood TX HF 1

批头组套，特别适用于木材加工。

867/4 TORX® HF 批头采用了特殊几何结构，符合 Acument Intellectual Properties 规格，可将 TORX® 螺丝稳定地固定在工具上！该批头适用于难以触及、不方便用另一只手握住螺丝的工作区域。

另外，此类批头还适用于 Würth ASSY 螺丝以及 Altenloh SPAX T-STAR plus 螺丝。

配Take it easy易寻色标系统：用特定颜色代表不同尺寸。

Bit-Check 可快速地简要了解所提供的工具。未使用的套头只需简单地放回固定器，且不会丢失。易于运输，例如可放在上衣插袋内。

Bit-Check 可以安放在工作区，这样可方便快速取用工具。

- 特别适用于木制工件
- 用于 TORX® 套筒螺丝
- TORX®梅花螺丝固持功能
- 另外，还适用于 Würth ASSY 螺丝以及 Altenloh SPAX T-STAR plus 螺丝
- 50mm长批头

Bit-Check 6 Wood TX HF 1



Code	EAN			
05056470001	226181			20
			867/4 TORX® HF 2x TX 20x50; 2x TX 25x50; 1x TX 30x50; 1x TX 40x50 ¹⁾	

¹⁾ Pound-thru 六角；无Take it easy易寻色标系统。

Bit-Check 6 Wood TX HF 1 SB



Code	EAN			
05073639001	227508			1
1x Bit-Check 6 Wood TX HF 1				
			867/4 TORX® HF 2x TX 20x50; 2x TX 25x50; 1x TX 30x50; 1x TX 40x50 ¹⁾	

¹⁾ Pound-thru 六角；无Take it easy易寻色标系统。

Bit-Check 30 金属工件专用批头套装 1

- 坚固而具有韧性的通用批头
- 通用夹具, 带不锈钢护套和强磁性磁铁

Bit-Check 30 金属工件专用批头套装 1



Code	EAN		
05057434001	179838		10
		●● 899/4/1 1x 1/4"x50	
		⊕ 851/1 Z PH 3x PH 1x25; 3x PH 2x25; 2x PH 3x25	
		⊕ 855/1 Z PZ 3x PZ 1x25; 3x PZ 2x25; 3x PZ 3x25	
		⊕ 867/1 TORX® 1x TX 10x25; 1x TX 15x25; 1x TX 20x25; 1x TX 25x25; 1x TX 30x25; 1x TX 40x25	
		⊖ 800/1 Z 1x 0,6x4,5x25; 1x 1,0x5,5x25; 1x 1,2x6,5x25	
		○ 840/1 Z Hex-Plus 1x 4,0x25; 1x 5,0x25; 1x 6,0x25	

Bit-Check 30 金属型 1 SB



Code	EAN		
05057440001	229632	●● 899/4/1 1x 1/4"x50	1
		⊕ 851/1 Z 3x PH 1x25; 3x PH 2x25; 2x PH 3x25	
		⊕ 855/1 Z 3x PZ 1x25; 3x PZ 2x25; 3x PZ 3x25	
		⊕ 867/1 TORX® 1x TX 10x25; 1x TX 15x25; 1x TX 20x25; 1x TX 25x25; 1x TX 30x25; 1x TX 40x25	
		⊖ 800/1 Z 1x 0.6x4.5x25; 1x 1.0x5.5x25; 1x 1.2x6.5x25	
		○ 840/1 Z 1x 4.0x25; 1x 5.0x25; 1x 6.0x25	



Bit-Check 12 金属工件专用批头套装 1



Code	EAN			
	4013288			
05057424001	179883		10	
		899/4/1 1x 1/4"x50		
		851/1 Z PH 1x PH 1x25; 1x PH 2x25		
		855/1 Z PZ 1x PZ 1x25; 1x PZ 2x25		
		867/1 TORX® 1x TX 15x25; 1x TX 20x25; 1x TX 25x25; 1x TX 30x25		
		840/1 Z Hex-Plus 1x 3,0x25; 1x 4,0x25; 1x 5,0x25		

Bit-Check 12 Metal 1 SB



Code	EAN			
	4013288			
05136393001	214003		1	
		899/4/1 1x 1/4"x50		
		851/1 Z PH 1x PH 1x25; 1x PH 2x25		
		855/1 Z PZ 1x PZ 1x25; 1x PZ 2x25		
		867/1 TORX® 1x TX 15x25; 1x TX 20x25; 1x TX 25x25; 1x TX 30x25		
		840/1 Z Hex-Plus 1x 3,0x25; 1x 4,0x25; 1x 5,0x25		

843 阶梯钻 · 4-20 mm

按照2mm递增分成9个阶梯, 用于最大厚度为4.5mm的材料, Ø10档位最大操作厚度为1mm (薄钢板铰钻)。

1/4"六角, 适用于DIN ISO 1173-D 6.3标准的接头。

843 阶梯钻 · 4-20 mm



	EAN								
Code	4013288	mm							
05104672001	117632	75,0							1

844 丝锥钻 · 公制

丝锥应用: 攻丝。1/4"驱动适用于符合DIN 3126-D 6.3 (ISO 1173) 标准的夹具。

六角轴可传递极高扭矩。经过精调的材料富有弹性, 使用寿命更长。定心属性极佳。笔直的切割。完美的碎屑清理。卡住风险低 • 精确的返回控制。良好的耐腐蚀性。

844 丝锥钻 · 公制



	EAN								
Code	4013288	mm	mm	mm					
05104666001	117571	3,0	10,00	33,0	M 3				1
05104667001	117588	4,0	11,00	35,0	M 4				1
05104668001	117595	5,0	12,50	36,0	M 5				1
05104669001	117601	6,0	18,00	40,0	M 6				1
05104670001	117618	8,0	20,00	40,0	M 8				1
05104671001	117625	10,0	20,00	40,0	M 10				1

844/7 丝锥钻组套

通用快速夹具, 用于 1/4"六角驱动的批头。

844/7 丝锥钻组套



Code	EAN			
05104754001	4013288			1
		●●	888/4/1 K 1x 1/4"x50	
		●	844 1x 3,0x33,0; 1x 4,0x35,0; 1x 5,0x36,0; 1x 6,0x40,0; 1x 8,0x40,0; 1x 10,0x40,0	

845 单刃铰钻

90°单刃铰钻应用: 去毛刺、倒角和扩孔。1/4"驱动适用于符合DIN 3126-D 6.3 (ISO 1173) 标准的夹具。六角轴可传递极高扭矩。1个端头。

无振动、无刮痕担保。最佳的扩孔表面质量。使用寿命更长。完美的碎屑清理。良好的耐腐蚀性。

845 单刃铰钻



Code	EAN	●	↓	↓	●		
		mm	mm	mm			
05104660001	117519	6,30	21,00	32,0	M 3		1
05104661001	117526	8,30	21,00	32,0	M 4		1
05104662001	117533	10,40	21,00	34,0	M 5		1
05104663001	117540	12,40	21,00	36,0	M 6		1
05104664001	117557	16,50	22,00	40,0	M 8		1
05104665001	117564	20,50	22,00	43,0	M 10		1

816 R

快速批头接杆, 用于 1/4"六角驱动的批头。

888/4/1 K

通用快速夹具, 用于 1/4"六角驱动的批头。

845/8 单刃铰钻组套



Code	EAN			
05104655001	4013288			1
		●	816 R 1x 1/4"x119	
		●●	888/4/1 K 1x 1/4"x50	
		●	845 1x 6,30x32,0; 1x 8,30x32,0; 1x 10,40x34,0; 1x 12,40x36,0; 1x 16,50x40,0; 1x 20,50x43,0	

846 三刃铰钻

90°三刃铰钻应用: 去毛刺、倒角和扩孔。1/4"驱动适用于符合DIN 3126-D 6.3 (ISO 1173) 标准的夹具。六角轴可传递极高扭矩。HSS=高速钢。

经过精调的材料富有弹性, 使用寿命更长。3个端头。定心属性极佳。笔直的切割。完美的碎屑清理。卡住风险低。精确的返回控制。良好的耐腐蚀性。

846 三刃铰钻



Code	EAN	●	↓	↓	↓		
		mm	mm	mm			
05104630001	101440	6,30	20,00	31,0	M 3		1
05104631001	101457	8,30	20,00	31,0	M 4		1
05104632001	101464	10,40	20,00	34,0	M 5		1
05104633001	101471	12,40	20,00	35,0	M 6		1
05104634001	101488	16,50	20,00	40,0	M 8		1
05104635001	101495	20,50	20,00	41,0	M 10		1

816 R

快速批头接杆, 用于 1/4"六角驱动的批头。

888/4/1 K

通用快速夹具, 用于 1/4"六角驱动的批头。

846/8 三刃镗钻组套



Code	EAN		
05104650001	111678		1
		816 R 1x 1/4"x119	
		888/4/1 K 1x 1/4"x50	
		846 HSS 1x 6,30x31,0; 1x 8,30x31,0; 1x 10,40x34,0; 1x 12,40x35,0; 1x 16,50x40,0; 1x 20,50x41,0	

847 HSS 复合钻

复合钻应用: 钻孔、攻丝和去毛刺一次成形。1/4"驱动适用于符合DIN 3126-D 6.3 (ISO 1173) 标准的夹具。六角轴可传递极高扭矩。HSS=高速钢。

经过精调的材料富有弹性, 使用寿命更长。定心属性极佳。笔直的切割。完美的碎屑清理。卡住风险低。精确的返回控制。

847 HSS 复合钻



Code	EAN						
05104640001	101501	2,5	12,00	36,0	M 3		1
05104641001	101518	3,3	12,00	39,0	M 4		1
05104642001	101525	4,2	12,00	41,0	M 5		1
05104643001	101532	5,0	12,00	44,0	M 6		1
05104644001	101549	6,8	12,00	51,0	M 8		1
05104645001	101556	8,5	12,00	59,0	M 10		1

888/4/1 K 通用快速批头接杆

- 无磁性设计

847/7 复合钻组套



Code	EAN		
05104751001	233035		1
		888/4/1 K 1x 1/4"x50	
		847 HSS 1x 2,5x36,0; 1x 3,3x39,0; 1x 4,2x41,0; 1x 5,0x44,0; 1x 6,8x51,0; 1x 8,5x59,0	

848 HSS 金属材料用麻花钻

用于金属材料的麻花钻应用: 1/4"驱动适用于符合DIN 3126-D 6.3 (ISO 1173) 标准的夹具。六角轴可传递极高扭矩。HSS=高速钢。

经过精调的材料富有弹性, 使用寿命更长。同心度极佳。经过回火处理的缓冲吸收型批头, 使用寿命超长。

848 HSS 金属材料用麻花钻



	EAN							
Code	4013288	mm	mm	mm				
05104610001	101310	3,0	16,00	38,0				1
05104611001	101327	3,1	18,00	40,0				1
05104612001	101334	3,3	18,00	40,0				1
05104613001	101341	4,0	20,00	44,0				1
05104614001	101358	4,1	20,00	44,0				1
05104615001	101365	4,2	20,00	45,0				1
05104616001	101372	5,0	26,00	50,0				1
05104617001	101389	5,1	26,00	50,0				1
05104618001	101396	6,0	26,00	50,0				1
05104619001	101402	6,8	30,00	50,0				1
05104620001	101419	8,0	32,00	51,0				1
05104621001	101426	8,5	33,00	53,0				1
05104622001	101433	10,0	38,00	54,0				1

849 HSS 木质材料专用麻花钻

用于木质材料的麻花钻应用: 1/4"驱动适用于符合DIN 3126-D 6.3 (ISO 1173) 标准的夹具。六角轴可传递极高扭矩。HSS=高速钢。

经过精调的材料富有弹性, 使用寿命更长。同心度极佳。经过回火处理的缓冲吸收型批头, 使用寿命超长。

849 HSS 木质材料专用麻花钻



	EAN							
Code	4013288	mm	mm	mm				
05104600001	101259	3,0	32,00	70,0				1
05104601001	101266	4,0	32,00	74,0				1
05104602001	101273	5,0	43,00	85,0				1
05104603001	101280	6,0	45,00	95,0				1
05104604001	101297	8,0	60,00	110,0				1
05104605001	101303	10,0	70,00	120,0				1

848/851/867/19 金属材料专用麻花钻和组套

- 19件套, 坚固腰包装
- 1个888/4/1 K通用快速批头接杆, 适用于电动工具和电钻, 金属材料麻花钻和批头带1/4"驱动, 适用于 DIN ISO 1173-D 6.3标准接头的电动工具

848/851/867/19 金属材料专用麻花钻和组套



Code	EAN			
05104652001	111654			1
			888/4/1 K 1x 1/4"x50	
			851/1 TZ PH 2x PH 1x25; 3x PH 2x25; 1x PH 3x25	
			848 HSS 1x 3,0x38,0; 1x 4,0x44,0; 1x 4,2x45,0; 1x 5,0x50,0; 1x 6,0x50,0; 1x 8,0x51,0	
			867/1 TORX® 1x TX 10x25; 1x TX 15x25; 1x TX 20x25; 1x TX 25x25; 1x TX 30x25; 1x TX 40x25	



849/855/867/18 木质材料专用麻花钻和组套

- 18件套, 坚固腰包装
- 1个889/4/1 K通用快速批头接杆, 适用于电动工具和电钻, 木质材料麻花钻和批头带 $\frac{1}{4}$ "驱动, 适用于 DIN ISO 1173-D 6.3标准接头的电动工具

849/855/867/18 木质材料专用麻花钻和组套



Code	EAN		
05104653001	4013288 111661		1
		889/4/1 K 1x $\frac{1}{4}$ "x50	
		849 HSS 1x 3,0x70,0; 1x 4,0x74,0; 1x 5,0x85,0; 1x 6,0x95,0; 1x 8,0x110,0	
		855/1 TH PZ 2x PZ 1x25; 3x PZ 2x25; 1x PZ 3x25	
		867/1 TORX® 1x TX 10x25; 1x TX 15x25; 1x TX 20x25; 1x TX 25x25; 1x TX 30x25; 1x TX 40x25	

Patio 施工工具套装 T 1

紧凑型 维拉 工具套装, 带 17 个最常见的旋拧工具, 适合庭院施工。

批头采用不锈钢设计, 防止外部锈蚀。由于可变螺钉深度限制, 采用的额外智能批头接头可实现均匀的深度, 并防止对装有毡环的地板造成损坏。

- 高质量 17 件式工具套装, 适用于庭院施工中地板的均匀平齐埋头螺钉
- 批头接头, 具有可调螺钉深度限制和防护毡环, 以保护表面
- 15 个批头 (TORX®、PH、PZ), 由不锈钢制成, 可防止外部锈蚀, 带 3888/4/1 K Rapidaptor 不锈钢快速接头
- “易寻”色标系统: 用特定的颜色代表不同端头种类和尺寸
- 紧凑型折叠袋, 与 维拉 2go 兼容, 包括4个备用毡环

Patio 施工工具套装 T 1



Code	EAN		
05134021001	4013288 219510		1
		881/4/1 1x $\frac{1}{4}$ "x90 ¹⁾	
		3888/4/1 K 1x $\frac{1}{4}$ "x50	
		3851/1 TS PH 1x PH 1x25; 1x PH 2x25; 1x PH 3x25	
		3855/1 TS PZ 1x PZ 1x25; 2x PZ 2x25; 1x PZ 3x25	
		3867/1 TS TORX® 1x TX 10x25; 1x TX 15x25; 1x TX 20x25; 1x TX 25x25; 1x TX 30x25; 1x TX 40x25	
		3867/1 TS P TORX® 2x TX 25x25	
		9201 4x 27,0	

¹⁾ 可订购带有 5 个毡环的备件包, 代码为 05130003001。

Bit-Check 10 墙用组套 1

套装批头，用于板墙结构中的应用。高质量的铝制间隔片；螺钉安装深度可以无限地调节，并且能够与埋头螺钉进行齐头对准；9个板墙结构钻头，具有修改的传动轴；长度25mm。

Bit-Check 10 墙用组套 1

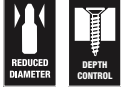

Code	EAN			
05136011001	4013288 178657			1
		●	896/4/1 1x 1/4"x50	
		+	851/1 RZ PH 9x PH 2x25	

Bit-Check 6 SHK 1 SB

6个Wera批头(长50mm)整齐置入实用且体积小的Bit-Check内。特别适用于管道、供暖和空调操作；Bit-Check允许快速查看可用的工具。未使用的套头只需简单地放回固定器，且不会丢失。易于运输，例如可放在上衣插袋内。批头坚固，通用。

- 内含特别适合暖通应用的批头
- 坚固而具有韧性的通用批头
- 齿尖的坚固设计可防止齿尖过早断裂
- Hex-Plus六角增强型可延长螺丝头的寿命
- 50mm长批头
- 可竖直存放，多重材料Bit-Check套装
- Bit-Check用塑料制成，保证了坚硬度和耐用性

Bit-Check 6 SHK 1 SB



Code	EAN			
05073631001	4013288 227997			1
		+	851/4 TZ 1x PH 1x50	
		★	867/4 Z TORX® 1x TX 15x50; 1x TX 20x50; 1x TX 25x50	
		○	840/4 Z 1x 5.0x50; 1x 6.0x50 ¹⁾	

¹⁾六角形刀片





扭矩工具

Kraftform 7400 系列可调式扭矩螺丝手柄 · 带快速接头

维拉可调式扭矩螺丝刀可用极大精度来设定所需扭矩值, 同时它沿用了维拉一贯的人体工程学设计, 使用户能获得满意的作业效果。可以直接手动设定所需的扭矩数值。易于读取的刻度值。

快速更换技术使批头和护套可以快速更换 无限制制扭矩用于松动螺丝的方向。Kraftform手柄的突出设计使手柄能完美地融入手中, 防止水泡和老茧等手部疲劳造成的损伤。

用于DIN ISO 1173 C 6.3和E 6.3标准的11/4内六角批头, 以及维拉系列1和4的批头。

Kraftform 7400 系列可调式扭矩螺丝手柄 (0.1-3.0 Nm) · 带快速接头



Code	EAN	Art.No.	批头	Nm	Nm	mm	mm	包装
05074770001 ¹⁾	179012	7430	1/4"	0,10-0,34	0,015	89	142	1
05074772001 ¹⁾	179128	7431	1/4"	0,30-1,00	0,05	89	142	1
05074774001 ¹⁾	179135	7432	1/4"	0,90-1,50	0,05	89	142	1
05074700001	100641	7440	1/4"	0,3-1,2	0,05	105	155	1
05074701001	100658	7441	1/4"	1,2-3,0	0,10	105	155	1

¹⁾ 附带放大镜, 提升了刻度的可视性。

7400 系列 Kraftform 可调节式扭矩螺丝手柄 (2.5-29.0 in. lbs.) · 带快速接头 · 英制



Code	EAN	Art.No.	批头	in. lbs.	in. lbs.	mm	mm	包装
05074710001	102881	7445	1/4"	2,5-11,5	0,5	105	155	1
05074711001	102898	7446	1/4"	11,0-29,0	1,0	105	155	1

7400 系列 Kraftform 可调式扭矩螺丝手柄 (3.0-8.8 Nm) · 枪形 · 带快速接头



Code	EAN	Art.No.	批头	Nm	Nm	mm	mm	包装
05074702001	101730	7442	1/4"	3,0-6,0	0,25	150	100	1
05074705001	119308	7443	1/4"	4,0-8,8	0,40	150	100	1

7400 系列 Kraftform 可调式扭矩螺丝手柄 (25.0-55.0 in. lbs.) · 枪形手柄 · 带快速接头



Code	EAN	Art.No.	批头	in. lbs.	in. lbs.	mm	mm	包装
05074712001	102904	7447	1/4"	25,0-55,0	2,5	150	100	1

9524 光伏安装工具组套 1

安装光伏系统的 7 件工具组套。一把 7442 扭矩扳手 (枪形手柄), 测量范围为 3.0-6.0 Nm。扭矩值的数字显示。可靠的防滑机构以及可在达到设定扭矩时发出提示音。一把 889/4/1 F Rapidaptor 批头夹持螺丝刀, 具有快速旋转功能, 在顺时针扭矩操作过程中无需取下工具即可快速返回。一把 6003 Joker 环形扳手。特殊的开口几何形状扩大了工具的放置可能性, 使环形扳手特别适用于狭窄的空间。用于 MC4 太阳能连接器 (多触点) 的 2 个安装工具。

一个用于安装面板连接器的 17 号 1/2" (一字) 套筒扳手嵌件, 一个用于手动套筒扳手嵌件的工具轴 (适配器 1/4" 到 1/2")。

- 用于安装光伏系统的螺丝刀组套
- 包括 2 个用于 MC4 太阳能连接器 (多触点) 的 9108 安装工具
- 包括带枪形手柄的 7442 扭矩扳手 (3.0-6.0 Nm)
- 包括 Rapidaptor 889/4/1 F 批头夹持螺丝刀, 具有快速旋转功能, 在顺时针扭矩操作过程中无需取下工具即可快速返回
- 包括 Joker 6003 环形扳手, 特别适合狭窄空间; 特殊的嘴部几何形状扩展了工具的放置可能性
- 包括用于安装面板连接器的 17 号 1/2" 套筒扳手嵌件 (一字)
- 包括工具轴 870/4 (适配器 1/4" 六角到 1/2" 方头), 用于手动操作 1/2" 套筒扳手嵌件

9524 光伏安装工具组套 1



Code	EAN		
05136043001	4013288 228017		1
		● 7400 枪形手柄 1x 7442, 3,0-6,0 Nm	
		● 8790 HMC Deep · 带切口 1x 17,0x76,0	
		○ 870/4 A 1x 1/4"x1/2"x72	
		● 889/4/1 F 1x 1/4"x64	
		6003 Joker 1x 17x190	
		9108 2x 115	
		魔术贴 120 1x 50,0x120,0	

7443/12 轮箍压力控制系统安装组套

12 件工具组套，妥善装卸轮胎压力控制系统。含扭矩技术，螺丝拧紧可控。Kraftform 多重材料手柄，符合人体工程学，可快速拆装螺丝。

5 个预设工具，用螺丝连接管接头螺母，并将传感器组件固定到阀门上。2 个预设阀门插入工具规格 0.25 和 0.45 Nm。可调 Kraftform 枪形手柄，扭矩值 4.0 至 8.8 Nm。适合所有定制轮胎压力控制系统。

得益于预定扭矩值的色标系统，拧紧作业可靠 (Beru/Huf®:TX 10 黄色 1.25 Nm; Schrader®: TX 10 绿色 1.4 Nm; Cup®/RTS®:TX 20 灰色 2.0 Nm)。

2 个 TX 批头含固持功能、套筒转接头、2 个套筒和多利阀 (用于至多 4.5 Nm 的应用)。适合轮胎控制系统，如 Schrader®、Alligator®、VDO®。预设扭矩螺丝刀固定在 3.3 Nm，可启动管接头螺母和 Alligator 系统传感器上的连接螺丝。

额外包含：套筒转接头、2 个批头、多利阀 (用于至多 4.5 Nm 的应用)。

7443/12 轮箍压力控制系统安装组套

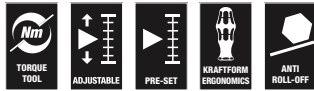

Code	EAN		
05074746001	4013288 178404		1
		7400 定扭式扭矩螺丝手柄·枪形手柄 1x 7443, 4,0-8,8 Nm	
		原厂预设扭矩值的7400系列Kraftform 预定制扭矩螺丝刀 (原厂预设扭矩值) 1x 7464, 3,3 Nm, 3,0-6,0 Nm	
		300 TX 1x TX 10x1,25; 1x TX 10x1,4	
		790 A/50 1x 11,0x50,0; 1x 12,0x50,0	
		867/4 TORX® HF 1x TX 15x50; 1x TX 20x50	
		870/1 1x 1/4"x25 ¹⁾	
		300 V 1x 0,25; 1x 0,45	
		327 1x 32x70	

¹⁾带摩擦球，用于手动螺母扳手套筒

7440/41 Kraftform 可调式扭矩螺丝刀组套 (0.3-3.0 Nm)

维拉扭矩螺丝刀组套。双扭矩螺丝刀，含扭矩可变设置选项，精度最高。

无需任何特殊工具，即可轻松调节所需扭矩值。易读的刻度值。

使用Rapidaptor 快速脱落技术，可快速更换批头。

通过无限扭矩松开卡住的螺钉。

多组件Kraftform手柄，具有硬质和软质区，适合高速操作，同时获得舒适的手感。优质稳定塑料盒收纳批头。

7440/41 Kraftform 可调式扭矩螺丝刀组套 (0.3-3.0 Nm)



Code	EAN		
05074738001	4013288 112354		1
		7400 1x 7440, 1/4", 0,3-1,2 Nm; 1x 7441, 1/4", 1,2-3,0 Nm	
		867/1 TZ TORX® 1x TX 6x25; 1x TX 7x25; 1x TX 8x25; 1x TX 9x25; 1x TX 10x25; 1x TX 15x25; 1x TX 20x25; 1x TX 25x25; 1x TX 30x25	
		867/1 IP TORX PLUS® 1x 6 IPx25; 1x 7 IPx25; 1x 8 IPx25; 1x 9 IPx25; 1x 10 IPx25; 1x 15 IPx25; 1x 20 IPx25; 1x 25 IPx25; 1x 30 IPx25	
		840/1 Z Hex-Plus 1x 2,0x25; 1x 2,5x25; 1x 3,0x25; 1x 4,0x25; 1x 5,0x25; 1x 6,0x25	

7440/41/42 Kraftform 可调式扭矩螺丝刀组套 (0.3-6.0 Nm)



Code	EAN		
05074739001	4013288 113924		1
		7400 1x 7440, 0,3-1,2 Nm; 1x 7441, 1,2-3,0 Nm	
		7400 定扭式扭矩螺丝手柄 · 枪形手柄 1x 7442, 3,0-6,0 Nm	
		867/1 TZ TORX® 1x TX 6x25; 1x TX 7x25; 1x TX 8x25; 1x TX 9x25; 1x TX 10x25; 1x TX 15x25; 1x TX 20x25; 1x TX 25x25; 1x TX 30x25	
		867/1 IP TORX PLUS® 1x 6 IPx25; 1x 7 IPx25; 1x 8 IPx25; 1x 9 IPx25; 1x 10 IPx25; 1x 15 IPx25; 1x 20 IPx25; 1x 25 IPx25; 1x 30 IPx25	
		840/1 Z 1x 2,0x25; 1x 2,5x25; 1x 3,0x25; 1x 4,0x25; 1x 5,0x25; 1x 6,0x25	

7445/46/47 Kraftform 可调式扭矩螺丝刀组套 (2.5-55.0 in. lbs.) · 英制



Code	EAN		
05350451001	4013288 161383		1
		7400 Imperial 1x 7445, 2,5-11,5 in. lbs.; 1x 7446, 11,0-29,0 in. lbs.	
		7400 Imperial 枪形手柄 1x 7447, 25,0-55,0 in. lbs.	
		867/1 TZ TORX® 1x TX 6x25; 1x TX 7x25; 1x TX 8x25; 1x TX 9x25; 1x TX 10x25; 1x TX 15x25; 1x TX 20x25; 1x TX 25x25; 1x TX 30x25	
		867/1 IP TORX PLUS® 1x 6 IPx25; 1x 7 IPx25; 1x 8 IPx25; 1x 9 IPx25; 1x 10 IPx25; 1x 15 IPx25; 1x 20 IPx25; 1x 25 IPx25; 1x 30 IPx25	
		840/1 Z 1x 2,0x25; 1x 2,5x25; 1x 3,0x25; 1x 4,0x25; 1x 5,0x25; 1x 6,0x25	

7443/61/9 轮胎压力控制系统安装组套

9 件工具组套, 妥善装卸轮胎压力控制系统。含扭矩技术, 螺丝拧紧可控。Kraftform 多重材料手柄, 符合人体工程学, 可快速拆装螺丝。

2 个预设工具, 用螺丝连接管接头螺母, 并将传感器组件固定到阀门上。

可调 Kraftform 枪形手柄, 扭矩值 4.0 至 8.8 Nm。2 个 TX 批头含固持功能、套筒转接头、2 个套筒和多利阀 (用于至多 4.5 Nm 的应用)。

适合轮胎控制系统, 如 Schrader®、Alligator®、VDO®。

7443/61/9 轮胎压力控制系统安装组套

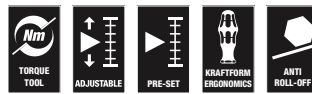

Code	EAN		
05074745001	4013288 168818		1
		原厂预设扭矩值的7400系列Kraftform预 式扭矩螺丝刀 (原厂预设扭矩值) 1x 7461, 1,2 Nm, 1,2-3,0 Nm ¹⁾	
		7400 定扭式扭矩螺丝手柄 · 枪形手柄 1x 7443, 4,0-8,8 Nm	
		300 TX 1x TX 10x1,4	
		870/1 1x 1/4"x25 ²⁾	
		790 A/50 1x 11,0x50,0; 1x 12,0x50,0	
		867/4 TORX® HF 1x TX 15x50; 1x TX 20x50	
		327 1x 32x70	

¹⁾ 可以更改预设扭矩。但是, 这需要使用专用工具和扭矩测试设备。请联系Wera扭矩服务部。

²⁾ 带摩擦球, 用于手动螺母扳手套筒

1430 Kraftform 精密 ESD 可调式扭矩螺丝手柄 (0.02-0.11 Nm) · 带快速释放接头

- 防静电工具, 表面电阻 $\leq 10^9$ Ohm
- 用于4mm半月和HIOS驱动的批头
- 可用于手机、移动电话、照相机及其他电子设备

1430 Kraftform 精密 ESD 可调式扭矩螺丝手柄 (0.02-0.11 Nm) · 带快速释放接头



Code	EAN	Art.No.	Nm	Nm	mm	mm	mm	mm	
05074802001 ¹⁾	179043	1430 ESD	0,02-0,06	0,0025	141	5 7/16"			1
05074804001 ¹⁾	179104	1431 ESD	0,05-0,11	0,005	141	5 7/16"			1

¹⁾ 附带放大镜, 提升了刻度的可视性。

7400 系列 Kraftform ESD 可调式扭矩螺丝手柄 (0.1-3.0 Nm) · 带快速接头

- 防静电工具, 表面电阻 $\leq 10^9$ Ohm

7400 系列 Kraftform ESD 可调式扭矩螺丝手柄 (0.1-3.0 Nm) · 带快速接头



Code	EAN	Art.No.	Nm	Nm	mm	mm	mm	mm	
05074780001 ¹⁾	179159	7430 ESD	1/4"	0,10-0,34	0,015	89	142	1	
05074782001 ¹⁾	179166	7431 ESD	1/4"	0,30-1,00	0,05	89	142	1	
05074784001 ¹⁾	179173	7432 ESD	1/4"	0,90-1,50	0,05	89	142	1	
05074730001	106964	7440 ESD	1/4"	0,3-1,2	0,05	105	155	1	
05074731001	106971	7441 ESD	1/4"	1,2-3,0	0,10	105	155	1	

¹⁾ 附带放大镜, 提升了刻度的可视性。

7400 系列 Kraftform ESD 可调式扭矩螺丝手柄 (2.5-29.0 in. lbs.) · 带快速接头

- 防静电工具, 表面电阻 $\leq 10^9$ Ohm

7400 系列 Kraftform ESD 可调式扭矩螺丝手柄 (2.5-29.0 in. lbs.) · 带快速接头



Code	EAN	Art.No.	Nm	Nm	mm	mm	mm	mm	
05074733001	106988	7445 ESD	1/4"	2,5-11,5	0,5	105	155	1	
05074734001	106995	7446 ESD	1/4"	11,0-29,0	1,0	105	155	1	

7400 系列 Kraftform ESD 可调式扭矩螺丝手柄 (0.1-1.0 Nm)

- 防静电工具, 表面电阻 $\leq 10^9$ Ohm
- 用于4mm半月和HIOS驱动的批头

7400 系列 Kraftform ESD 可调式扭矩螺丝手柄 (0.1-1.0 Nm)



Code	EAN	Art.No.	Nm	Nm	mm	mm	mm	mm	
05074786001 ¹⁾	179036	7435 ESD	0,10-0,34	0,015	89	142	5 7/16"	1	
05074788001 ¹⁾	179029	7436 ESD	0,30-1,00	0,05	89	142	5 7/16"	1	

¹⁾ 附带放大镜, 提升了刻度的可视性。

Kraftform 7400 系列扭矩螺丝手柄系列 · 预制式扭矩螺丝刀 (原厂预设扭矩值)

维拉扭矩螺丝刀。

用户未指定扭矩值时原厂预设扭矩值为最小刻度值。针对在连续作业时所需要的定扭和精度。

可以在原厂设定的测量范围内使用专用的工具重新定扭 (可购入商品编号为05137003001的校准用工具组) 。

然后, 您可以使用现成可便携式扭矩检测器检查设定的扭矩值。

在 松开紧固的螺丝时扭矩并无特别限制。Rapidaptor快速接头技术简化接驳使插换更迅速。

适用依照DIN ISO 1173-C 6.3和E 6.3 (ISO 1173) 标准制造 $\frac{1}{4}$ "外六角驱动。复合材质的Kraftform手柄带硬质区和软质区, 可提升作业效率, 手柄形状贴合掌形容易上手。

请注意: 1 Ncm = 0.01 Nm。

原厂预设扭矩值 (0.3-3.0 Nm) 的 Kraftform 7400 系列扭矩扳手 · 带 Rapidaptor 快速释放夹持 · 手柄尺寸 105 mm

维拉扭矩螺丝刀。

用户未指定扭矩值时原厂预设扭矩值为最小刻度值。针对在连续作业时所需要的定扭和精度。可以在原厂设定的测量范围内使用专用的工具重新定扭 (可购入商品编号为05137001001的校准用工具组) 。

然后, 您可以使用现成可便携式扭矩检测器检查设定的扭矩值。在 松开紧固的螺丝时扭矩并无特别限制。Rapidaptor快速接头技术简化接驳使插换更迅速。

适用依照DIN ISO 1173-C 6.3和E 6.3 (ISO 1173) 标准制造 $\frac{1}{4}$ "外六角驱动。

复合材质的Kraftform手柄带硬质区和软质区, 可提升作业效率, 手柄形状贴合掌形容易上手。

请注意: 1 Ncm = 0.01 Nm。

原厂预设扭矩值 (0.1-1.5 Nm) 的 Kraftform 7400 系列扭矩扳手 · 带 Rapidaptor 快速释放夹持 · 手柄尺寸 89 mm



Code	EAN	Art.No.						
05074790001 ¹⁾	179395	7450	$\frac{1}{4}$ "	0,1	0,1-0,34	89	133	1
05074792001 ¹⁾	179203	7451	$\frac{1}{4}$ "	0,3	0,3-1,0	89	133	1
05074794001 ¹⁾	179197	7452	$\frac{1}{4}$ "	0,9	0,9-1,5	89	133	1

¹⁾ 可以更改预设扭矩。但是, 这需要使用专用工具和扭矩测试设备。请联系Wera扭矩服务部。

原厂预设扭矩值 (0.3-3.0 Nm) 的 Kraftform 7400 系列扭矩扳手 · 带 Rapidaptor 快速释放夹持 · 手柄尺寸 105 mm



Code	EAN	Art.No.						
05074715001 ¹⁾	102911	7460	$\frac{1}{4}$ "	0,3	0,3-1,2	105	155	1
05074716001 ¹⁾	102928	7461	$\frac{1}{4}$ "	1,2	1,2-3,0	105	155	1

¹⁾ 可以更改预设扭矩。但是, 这需要使用专用工具和扭矩测试设备。请联系Wera扭矩服务部。



原厂预设扭矩值 (3.0-8.8 Nm) 的 Kraftform 7400 系列扭矩扳手，带 Rapidaptor 快速释放夹持，枪形手柄
 维拉扭矩螺丝刀。

符合人体工学设计的Kraftform枪型复合材质手柄适合在高扭矩传输和装懂作业时的握持。用户未指定扭矩值时原厂预设扭矩值为最小刻度值。针对在连续作业时所需要的定扭和精度。

可以在原厂设定的测量范围内使用专用的工具重新定扭 (可购入商品编号为05137002001的校准用工具组)。

然后，您可以使用现成可携式扭矩检测器检查设定的扭矩值。

在 松开紧固的螺丝时扭矩并无特别限制。 Rapidaptor快速接头技术简化接驳使插换更迅速。

适用依照DIN ISO 1173-C 6.3和E 6.3 (ISO 1173) 标准制造 1/4"外六角驱动。

复合材质的Kraftform手柄带硬质区和软质区，可提升作业效率，手柄形状贴合掌形容易上手。

请注意: 1 Ncm = 0.01 Nm

原厂预设扭矩值 (3.0-8.8 Nm) 的 Kraftform 7400 系列扭矩扳手，带 Rapidaptor 快速释放夹持，枪形手柄

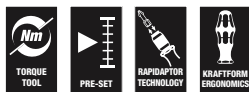

	EAN							
Code	4013288	Art.No.						
05074717001 ¹⁾	102935	7462	1/4"	3,0	3,0-6,0	150	100	1
05074728001 ¹⁾	156167	7463	1/4"	4,0	4,0-8,8	150	100	1

¹⁾可以更改预设扭矩。但是，这需要使用专用工具和扭矩测试设备。请联系Wera扭矩服务部。

原厂预设扭矩值 (2.5-29.0 in. lbs.) 的 Kraftform 7400 Imperial 系列扭矩扳手，带 Rapidaptor 快速释放夹持，手柄尺寸 105 mm

维拉扭矩螺丝刀。用户未指定扭矩值时原厂预设扭矩值为最小刻度值。

针对在连续作业时所需要的定扭和精度。可以在原厂设定的测量范围内使用专用的工具重新定扭 (可购入商品编号为05137001001的校准用工具组)。

然后，您可以使用现成可携式扭矩检测器检查设定的扭矩值。

在 松开紧固的螺丝时扭矩并无特别限制。 Rapidaptor快速接头技术简化接驳使插换更迅速。

适用依照DIN ISO 1173-C 6.3和E 6.3 (ISO 1173) 标准制造 1/4"外六角驱动。

复合材质的Kraftform手柄带硬质区和软质区，可提升作业效率，手柄形状贴合掌形容易上手。

请注意: 1 Ncm = 0.01 Nm.

原厂预设扭矩值 (2.5-29.0 in. lbs.) 的 Kraftform 7400 Imperial 系列扭矩扳手，带 Rapidaptor 快速释放夹持，手柄尺寸 105 mm



	EAN							
Code	4013288	Art.No.						
05074720001 ¹⁾	102942	7465	1/4"	2,5	2,5-11,5	105	155	1
05074722001 ¹⁾	103116	7466	1/4"	11,0	11,0-29,0	105	155	1

¹⁾可以更改预设扭矩。但是，这需要使用专用工具和扭矩测试设备。请联系Wera扭矩服务部。

原厂预设扭矩值 (25.0-55.0 in. lbs.) 的 Kraftform 7400 Imperial 系列扭矩扳手，带 Rapidaptor 快速释放夹持，枪形手柄

维拉扭矩螺丝刀。符合人体工学设计的Kraftform枪型复合材质手柄适合在高扭矩传输和装懂作业时的握持。

用户未指定扭矩值时原厂预设扭矩值为最小刻度值。针对在连续作业时所需要的定扭和精度。

可以在原厂设定的测量范围内使用专用的工具重新定扭 (可购入商品编号为05137002001的校准用工具组)。

然后，您可以使用现成可携式扭矩检测器检查设定的扭矩值。在 松开紧固的螺丝时扭矩并无特别限制。

Rapidaptor快速接头技术简化接驳使插换更迅速。

适用依照DIN ISO 1173-C 6.3和E 6.3 (ISO 1173) 标准制造 1/4"外六角驱动。

复合材质的Kraftform手柄带硬质区和软质区，可提升作业效率，手柄形状贴合掌形容易上手。

请注意: 1 Ncm = 0.01 Nm

原厂预设扭矩值 (0.1-1.5 Nm) 的 Kraftform 7400 ESD系列扭矩扳手，带 Rapidaptor 快速释放夹持，手柄尺寸 105 mm

维拉扭矩螺丝刀。防止相关静电产生后的危害。用户未指定扭矩值时原厂预设扭矩值为最小刻度值。

针对在连续作业时所需要的定扭和精度。

可以在原厂设定的测量范围内使用专用的工具重新定扭 (可购入商品编号为05137003001的校准用工具组)。

然后，您可以使用现成可携式扭矩检测器检查设定的扭矩值。

在 松开紧固的螺丝时扭矩并无特别限制。 Rapidaptor快速接头技术简化接驳使插换更迅速。

复合材质的Kraftform手柄带硬质区和软质区，可提升作业效率，手柄形状贴合掌形容易上手。

适用依照

DIN ISO 1173-C 6.3和E 6.3 (ISO 1173) 标准制造 1/4"外六角驱动批头。

请注意: 1 Ncm = 0.01 Nm

- 防静电工具, 表面电阻 $\leq 10^9$ Ohm

原厂预设扭矩值 (25.0-55.0 in. lbs.) 的 Kraftform 7400 Imperial 系列扭矩扳手，带 Rapidaptor 快速释放夹持，枪形手柄

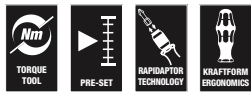

	EAN							
Code	4013288	Art.No.		in. lbs.	in. lbs.	mm	mm	
05074721001 ¹⁾	102959	7467	1/4"	25,0	25,0-55,0	150	100	1

¹⁾可以更改预设扭矩。但是，这需要使用专用工具和扭矩测试设备。请联系Wera扭矩服务部。

原厂预设扭矩值 (0.1-1.5 Nm) 的 Kraftform 7400 ESD系列扭矩扳手，带 Rapidaptor 快速释放夹持，手柄尺寸 105 mm



	EAN							
Code	4013288	Art.No.		Nm	Nm	mm	mm	
05074840001 ¹⁾	179487	7460 ESD	1/4"	0,3	0,3-1,2	105	155	1
05074842001 ¹⁾	179098	7461 ESD	1/4"	1,2	1,2-3,0	105	155	1

¹⁾可以更改预设扭矩。但是，这需要使用专用工具和扭矩测试设备。请联系Wera扭矩服务部。

原厂预设扭矩值 (0.1-1.5 Nm) 的 Kraftform 7400 ESD 系列扭矩扳手，带 Rapidaptor 快速释放夹持，手柄尺寸 89 mm

维拉扭矩螺丝刀。防止相关静电产生后的危害。用户未指定扭矩值时原厂预设扭矩值为最小刻度值。

针对在连续作业时所需要的定扭和精度。

可以在原厂设定的测量范围内使用专用的工具重新定扭 (可购入商品编号为05137003001的校准用工具组)。

然后，您可以使用现成可携式扭矩检测器检查设定的扭矩值。

在 松开紧固的螺丝时扭矩并无特别限制。

复合材质的Kraftform手柄带硬质区和软质区，可提升作业效率，手柄形状贴合掌形容易上手。

适用依照DIN ISO 1173-C 6.3和E 6.3 (ISO 1173) 标准制造 1/4" 外六角驱动批头。

请注意: 1 Ncm = 0.01 Nm

- 防静电工具，表面电阻 $\leq 10^9$ Ohm

原厂预设扭矩值 (0.1-1.5 Nm) 的 Kraftform 7400 ESD 系列扭矩扳手，带 Rapidaptor 快速释放夹持，手柄尺寸 89 mm

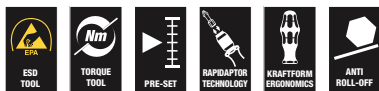

Code	EAN	Art.No.	1/4"	Nm	Nm	mm	mm	
05074820001 ¹⁾	179210	7450 ESD	1/4"	0,1	0,1-0,34	89	133	1
05074822001 ¹⁾	179470	7451 ESD	1/4"	0,3	0,3-1,0	89	133	1
05074824001 ¹⁾	179227	7452 ESD	1/4"	0,9	0,9-1,5	89	133	1

¹⁾可以更改预设扭矩。但是，这需要专用工具和扭矩测试设备。请联系Wera扭矩服务部。

原厂预设扭矩值 (0.1-1.0 Nm) 的 Kraftform 7400 ESD系列扭矩扳手，带快速释放夹持

维拉扭矩螺丝刀。防止相关静电产生后的危害。用户未指定扭矩值时原厂预设扭矩值为最小刻度值。针对在连续作业时所需要的定扭和精度。

可以在原厂设定的测量范围内使用专用的工具重新定扭 (可购入商品编号为05137003001的校准用工具组)。

然后，您可以使用现成可携式扭矩检测器检查设定的扭矩值。带快速接头，可快速更换批头。在 松开紧固的螺丝时扭矩并无特别限制。

复合材质的Kraftform手柄带硬质区和软质区，可提升作业效率，手柄形状贴合掌形容易上手。

适用于4mm半月型 (维拉9系列) 和4mm双耳型 (维拉21系列) 驱动批头。

请注意: 1 Ncm = 0.01 Nm

- 防静电工具，表面电阻 $\leq 10^9$ Ohm
- 用于4mm半月和HIOS驱动的批头

原厂预设扭矩值 (0.1-1.0 Nm) 的 Kraftform 7400 ESD系列扭矩扳手，带快速释放夹持



Code	EAN	Art.No.	Nm	Nm	mm	mm	
05074826001 ¹⁾	179067	7455 ESD	0,1	0,1-0,34	89	138	5 1/4" 1
05074828001 ¹⁾	179050	7456 ESD	0,3	0,3-1,0	89	138	5 1/4" 1

¹⁾可以更改预设扭矩。但是，这需要专用工具和扭矩测试设备。请联系Wera扭矩服务部。

原厂预设扭矩值 (0.02-0.11 Nm) 的 1460 ESD Kraftform Micro 扭矩扳手 · 带快速释放夹持

用户未指定扭矩值时原厂预设扭矩值为最小刻度值。针对在连续作业时所需要的定扭和精度。

可以在原厂设定的测量范围内使用专用的工具重新定扭 (可购入商品编号为05137004001的校准用工具组)。

然后, 您可以使用现成可携式扭矩检测器检查设定的扭矩值。不占空间的手柄/插换式换接头, 适合需要控制扭矩并防止静电的连续作业。

Kraftform防静电扭矩螺丝刀非常适合应用在易产生静电的电子组件上的紧固作业。

适用于4mm半月驱动 (Wera系列9) 和4毫米双耳驱动 (Wera系列21) 的批头。防盗。当达到设定扭矩时, 发出清晰的声音和触觉反馈, 使得连续作业的稳定性得到100%保证。在 松开紧固的螺丝时扭矩并无特别限制。

表面电阻 $\leq 10^9$ Ohm, 可提供安全的防静电保护。根据DIN EN 61340-5-1进行制造。

手柄/插换式换接头便于快速更换批头。

Kraftform精密手柄带有旋转盖和快速旋转区, 无需费时为了加速转动而重新调整手指位置。带有集成软区的力量区可确保传递高拧紧和松开的扭矩。

接头上方的精密区, 方便调校时校准角度用。快速固定批头: 要更换批头时, 只需将套筒向前推并卸下批头即可。

接头上的套筒可自由转动, 便于在拧螺丝过程中操作工具。适用于使用电动螺丝刀 (包括HIOS, Delvo, Sehan), 手动和机器连接的批头。

可应用于智能手机, 手机, 相机, 精密电子设备, 牙科实验室和牙科手术室。

请注意: 1 Ncm = 0.01 Nm

- 防静电工具, 表面电阻 $\leq 10^9$ Ohm
- 用于4mm半月和HIOS驱动的批头夹具
- 可用于手机、移动电话、照相机及其他电子设备

原厂预设扭矩值 (0.02-0.11 Nm) 的 1460 ESD Kraftform Micro 扭矩扳手 · 带快速释放夹持



	EAN						
Code	4013288	Art.No.	Nm	Nm	mm		
05074800001 ¹⁾	168351	1460 ESD	0,035	0,02-0,06	131	5 1/4"	1
05074810001 ¹⁾	179463	1461 ESD	0,050	0,05-0,11	131	5 1/4"	1

¹⁾可以更改预设扭矩。但是, 这需要使用专用工具和扭矩测试设备。请联系Wera扭矩服务部。

7400 系列 Kraftform 定扭螺丝刀，可指定出厂扭矩值，手柄长度 89 mm

维拉扭矩螺丝刀。

出厂时预设为客户指定扭矩值。针对在连续作业时所需要的定扭和精度。

可以在原厂设定的测量范围内使用专用的工具重新定扭（可购入商品编号为05137003001的校准用工具组）。

然后，您可以使用现成便携式扭矩检测器检查设定的扭矩值。

在 松开紧固的螺丝时扭矩并无特别限制。

Rapidaptor快速接头技术简化接驳使插换更迅速。

适用依照DIN ISO 1173-C 6.3和E 6.3 (ISO 1173) 标准制造 1/4"外六角驱动。

复合材质的Kraftform手柄带硬质区和软质区，可提升作业效率，手柄形状贴合掌形容易上手。

请注意：1 Ncm = 0.01 Nm。

7400 系列 Kraftform 定扭螺丝刀，可指定出厂扭矩值，手柄长度 89 mm



Code	EAN	Art.No.						
Code	EAN	Art.No.	Nm	mm	mm	mm		
05074790010	188106	7450	1/4"	0,1-0,34	89	133	5 1/4"	1
05074792010	188113	7451	1/4"	0,3-1,0	89	133	5 1/4"	1
05074794010	188137	7452	1/4"	0,9-1,5	89	133	5 1/4"	1

^{*)} 所需设置可以用以下单位表示：Nm、kgf.m、lbf.ft.、ozf.in.、dN.m、kgf.cm、lbf.in.、in. oz.、cN.m、gf.m、ft.lb.、gf.cm.、in. lb.

7400 系列 Kraftform 定扭螺丝刀，可指定出厂扭矩值，手柄长度 105 mm

维拉扭矩螺丝刀。

出厂时预设为客户指定扭矩值。

针对在连续作业时所需要的定扭和精度。

可以在原厂设定的测量范围内使用专用的工具重新定扭（可购入商品编号为05137001001的校准用工具组）。

然后，您可以使用现成便携式扭矩检测器检查设定的扭矩值。

在 松开紧固的螺丝时扭矩并无特别限制。 Rapidaptor快速接头技术简化接驳使插换更迅速。

适用依照DIN ISO 1173-C 6.3和E 6.3 (ISO 1173) 标准制造 1/4"外六角驱动。

复合材质的Kraftform手柄带硬质区和软质区，可提升作业效率，手柄形状贴合掌形容易上手。

请注意：1 Ncm = 0.01 Nm

- 用户指定预设扭矩值带有Rapidaptor快速释放接头的扭矩螺丝刀
- 扭矩在可调整扭力范围内需使用专用工具重新定扭
- 用于1/4"六角头驱动的批头
- 当达到设定值时会发出清晰的响声信号
- Kraftform多重材料手柄，可快速作业

7400 系列 Kraftform 定扭螺丝刀，可指定出厂扭矩值，手柄长度 105 mm



Code	EAN	Art.No.						
Code	EAN	Art.No.	Nm	mm	mm	mm		
05074715010	188144	7460	1/4"	0,3-1,2	105	155	6"	1
05074716010	188151	7461	1/4"	1,2-3,0	105	155	6"	1

^{*)} 所需设置可以用以下单位表示：Nm、kgf.m、lbf.ft.、ozf.in.、dN.m、kgf.cm、lbf.in.、in. oz.、cN.m、gf.m、ft.lb.、gf.cm.、in. lb.

7400 系列 Kraftform 定扭螺丝刀，可指定出厂扭矩值，枪形

维拉扭矩螺丝刀。

符合人体工学设计的Kraftform枪型复合材质手柄适合在高扭矩传输和装懂作业时的握持。

出厂时预设为客户指定扭矩值。

针对在连续作业时所需要的定扭和精度。

可以在原厂设定的测量范围内使用专用的工具重新定扭 (可购入商品编号为05137002001的校准用工具组)。

然后，您可以使用现成可携式扭矩检测器检查设定的扭矩值。

在 松开紧固的螺丝时扭矩并无特别限制。

Rapidaptor快速接头技术简化接驳使插换更迅速。

适用依照DIN ISO 1173-C 6.3和E 6.3 (ISO 1173) 标准制造 1/4"外六角驱动。复合材质的Kraftform手柄带硬质区和软质区，可提升作业效率，手柄形状贴合掌心容易上手。

请注意: 1 Ncm = 0.01 Nm

7400 系列 Kraftform 定扭螺丝刀，可指定出厂扭矩值，枪形



	EAN							
Code	4013288	Art.No.		Nm	mm	mm		
05074717010	188168	7462	1/4"	3,0-6,0	150	100	6"	1
05074728010	188199	7463	1/4"	4,0-8,8	150	100	6"	1

^{*)} 所需设置可以用以下单位表示: Nm, kgf.m, lbf.ft., ozf.in., dN.m, kgf.cm, lbf.in, in. oz, cN.m, gf.m, ft.lb, gf.cm, in. lb.

7400 Imperial 系列 Kraftform 定扭式扭矩螺丝手柄 (2.5-29.0 in. lbs.)，带快速接头

维拉扭矩螺丝刀。

出厂时预设为客户指定扭矩值。

针对在连续作业时所需要的定扭和精度。

可以在原厂设定的测量范围内使用专用的工具重新定扭 (可购入商品编号为05137001001的校准用工具组)。

然后，您可以使用现成可携式扭矩检测器检查设定的扭矩值。在 松开紧固的螺丝时扭矩并无特别限制。

Rapidaptor快速接头技术简化接驳使插换更迅速。

适用依照DIN ISO 1173-C 6.3和E 6.3 (ISO 1173) 标准制造 1/4"外六角驱动。

复合材质的Kraftform手柄带硬质区和软质区，可提升作业效率，手柄形状贴合掌心容易上手。

请注意: 1 Ncm = 0.01 Nm

7400 Imperial 系列 Kraftform 定扭式扭矩螺丝手柄 (2.5-29.0 in. lbs.)，带快速接头



	EAN							
Code	4013288	Art.No.		in. lbs.	mm	mm		
05074720010	188250	7465	1/4"	2,5-11,5	105	155	6"	1
05074722010	188267	7466	1/4"	11,0-29,0	105	155	6"	1

^{*)} 所需设置可以用以下单位表示: Nm, kgf.m, lbf.ft., ozf.in., dN.m, kgf.cm, lbf.in, in. oz, cN.m, gf.m, ft.lb, gf.cm, in. lb.

7400 Imperial 系列 Kraftform 定扭螺丝刀，可指定出厂扭矩值，枪形

维拉扭矩螺丝刀。

符合人体工学设计的Kraftform枪型复合材质手柄适合在高扭矩传输和装懂作业时的握持。

出厂时预设为客户指定扭矩值。针对在连续作业时所需要的定扭和精度。

可以在原厂设定的测量范围内使用专用的工具重新定扭（可购入商品编号为05137002001的校准用工具组）。

然后，您可以使用现成便携式扭矩检测器检查设定的扭矩值。在松开紧固的螺丝时扭矩并无特别限制。Rapidaptor快速接头技术简化接驳使插换更迅速。

适用依照DIN ISO 1173-C 6.3和E 6.3 (ISO 1173) 标准制造 1/4"外六角驱动。

复合材质的Kraftform手柄带硬质区和软质区，可提升作业效率，手柄形状贴合掌形容易上手。

请注意：1 Ncm = 0.01 Nm

7400 Imperial 系列 Kraftform 定扭螺丝刀，可指定出厂扭矩值，枪形

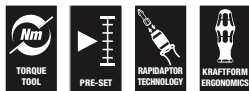

	EAN							
Code	4013288	Art.No.		in. lbs.	mm	mm		
05074721010	188274	7467	1/4"	25,0-55,0	150	100	6"	1

所需设置可以用以下单位表示：Nm、kgf.m、lbf.ft.、ozf.in.、dNm、kgf.cm、lbf.in.、in. oz.、cN.m、gf.m、ft.lb.、gf.cm.、in. lb.

1460 ESD Kraftform 精密 定扭螺丝刀，可指定出厂扭矩值，枪形

出厂时预设为客户指定扭矩值。可以在原厂设定的测量范围内使用专用的工具重新定扭（可购入商品编号为05137004001的校准用工具组）。

然后，您可以使用现成便携式扭矩检测器检查设定的扭矩值。

不占空间的手柄/插换式换接头，适合需要控制扭矩并防止静电的连续作业。

Kraftform防静电扭矩螺丝刀非常适合应用在易产生静电的电子组件上的紧固作业。适用于4mm半月驱动 (Wera系列9) 和4毫米双耳驱动 (Wera系列21) 的批头。防盗。当达到设定扭矩时，发出清晰的声音和触觉反馈，使得连续作业的稳定性得到100%保证。

在松开紧固的螺丝时扭矩并无特别限制。表面电阻 $\leq 10^9$ ，可提供安全的防静电保护。

根据DIN EN 61340-5-1进行制造。手柄/插换式换接头便于快速更换批头。

Kraftform精密手柄带有旋转盖和快速旋转区，无需费时为了加速转动而重新调整手指位置。带有集成软区的力量区可确保传递高拧紧和松开的扭矩。

接头上方的精密区，方便调校时校准角度用。

快速固定批头：要更换批头时，只需将套筒向前推并卸下批头即可。

接头上的套筒可自由转动，便于在拧螺丝过程中操作工具。

适用于使用电动螺丝刀 (包括HIOS, Delvo, Sehan)，手动和机器连接的批头。

可应用于智能手机，手机，相机，精密电子设备，牙科实验室和牙科手术室。

请注意：1 Ncm = 0.01 Nm

- 防静电工具，表面电阻 $\leq 10^9$ Ohm
- 用于4mm半月和HIOS驱动的批头夹具
- 可用于手机、移动电话、照相机及其他电子设备

1460 ESD Kraftform 精密 定扭螺丝刀 · 可指定出厂扭矩值 · 枪形

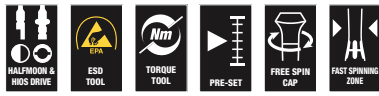

	EAN						
Code	4013288	Art.No.	Nm	mm			
05074800010	188304	1460 ESD	0,02-0,06	131	5 1/4"		1
05074810010	188311	1461 ESD	0,05-0,11	131	5 1/4"		1

^{*)} 所需设置可以用以下单位表示: Nm、kgf.m、lbf.ft.、ozf.in.、dN.m、kgf.cm、lbf.in.、in. oz.、cN.m、gf.m、ft.lb.、gf.cm.、in. lb.

7400 ESD 系列 Kraftform 定扭螺丝刀 · 可指定出厂扭矩值 · 手柄长度 105 mm

维拉扭矩螺丝刀。

防止相关静电产生后的危害。出厂时预设为客户指定扭矩值。针对在连续作业时所需要的定扭和精度。

可以在原厂设定的测量范围内使用专用的工具重新定扭 (可购入商品编号为05137001001的校准用工具组)。

然后, 您可以使用现成可便携式扭矩检测器检查设定的扭矩值。在松开紧固的螺丝时扭矩并无特别限制。

Rapidaptor快速接头技术简化接驳使插换更迅速。适用依照DIN ISO 1173-C 6.3和E 6.3 (ISO 1173) 标准制造 1/4"外六角驱动批头。

复合材质的Kraftform手柄带硬质区和软质区, 可提升作业效率, 手柄形状贴合掌心容易上手。

请注意: 1 Ncm = 0.01 Nm

- 防静电工具, 表面电阻 ≤ 10⁹ Ohm

7400 ESD 系列 Kraftform 定扭螺丝刀 · 可指定出厂扭矩值 · 手柄长度 105 mm



	EAN							
Code	4013288	Art.No.	Nm	mm	mm			
05074840010	188236	7460 ESD	1/4"	0,3-1,2	105	133	6"	1
05074842010	188243	7461 ESD	1/4"	1,2-3,0	105	155	6"	1

^{*)} 所需设置可以用以下单位表示: Nm、kgf.m、lbf.ft.、ozf.in.、dN.m、kgf.cm、lbf.in.、in. oz.、cN.m、gf.m、ft.lb.、gf.cm.、in. lb.

7400 ESD 系列 Kraftform 定扭螺丝刀，可指定出厂扭矩值，手柄长度 89 mm

维拉扭矩螺丝刀。防止相关静电产生后的危害。

出厂时预设为客户指定扭矩值。

针对在连续作业时所需要的定扭和精度。

可以在原厂设定的测量范围内使用专用的工具重新定扭（可购入商品编号为05137003001的校准用工具组）。

然后，您可以使用现成可携式扭矩检测器检查设定的扭矩值。

在 松开紧固的螺丝时扭矩并无特别限制。

Rapidaptor快速接头技术简化接驳使插换更迅速。适用依照DIN ISO 1173-C 6.3和E 6.3 (ISO 1173) 标准制造 1/4"外六角驱动批头。

复合材质的Kraftform手柄带硬质区和软质区，可提升作业效率，手柄形状贴合掌形容易上手。

请注意：1 Ncm = 0.01 Nm

- 防静电工具，表面电阻 $\leq 10^9$ Ohm

7400ESD 系列 Kraftform 定扭螺丝刀，可指定出厂扭矩值，手柄长度 89 mm

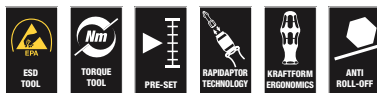

	EAN							
Code	4013288	Art.No.	Nm	mm	mm			
05074820010	188205	7450 ESD	1/4"	0,1-0,34	89	133	5 1/4"	1
05074822010	188212	7451 ESD	1/4"	0,3-1,0	89	133	5 1/4"	1
05074824010	188229	7452 ESD	1/4"	0,9-1,5	89	133	5 1/4"	1

^{*)} 所需设置可以用以下单位表示：Nm、kgf.m、lbf.ft.、ozf.in.、dN.m、kgf.cm、lbf.in.、in. oz.、cN.m、gf.m、ft.lb.、gf.cm.、in. lb.

7400 ESD 系列 Kraftform 定扭螺丝刀，可指定出厂扭矩值，带快速释放接头

维拉扭矩螺丝刀。

防止相关静电产生后的危害。

用户未指定扭矩值时原厂预设扭矩值为最小刻度值。

针对在连续作业时所需要的定扭和精度。

可以在原厂设定的测量范围内使用专用的工具重新定扭（可购入商品编号为05137003001的校准用工具组）。

然后，您可以使用现成可携式扭矩检测器检查设定的扭矩值。

在松开紧固的螺丝时扭矩并无特别限制。

复合材质的Kraftform手柄带硬质区和软质区，可提升作业效率，手柄形状贴合掌形容易上手。适用于4mm半月型（维拉9系列）和4mm双耳型（维拉21系列）驱动批头。

请注意：1 Ncm = 0.01 Nm

- 防静电工具，表面电阻 $\leq 10^9$ Ohm
- 用于4mm半月和HIOS驱动的批头

7400 ESD 系列 Kraftform 定扭螺丝刀，可指定出厂扭矩值，带快速释放接头



	EAN							
Code	4013288	Art.No.	Nm	mm	mm			
05074826010	188281	7455 ESD	0,1-0,34	89	138	5 1/4"		1
05074828010	188298	7456 ESD	0,3-1,0	89	138	5 1/4"		1

^{*)} 所需设置可以用以下单位表示：Nm、kgf.m、lbf.ft.、ozf.in.、dN.m、kgf.cm、lbf.in.、in. oz.、cN.m、gf.m、ft.lb.、gf.cm.、in. lb.

7510 Kraftform Safe-Torque 快速扭矩扳手 · 1-3 Nm

- 可快速调整扭矩的扭力起子
- 轻松快速的扭矩设置
- 固定位置 (扭矩锁) 用于无限制的拧紧和松开扭矩
- 顺时针/逆时针扭矩控制的安全滑动扭矩功能
- 快速轻松地设置可选的拧紧扭矩 (1.0; 1.5; 2.0; 2.5; 3.0 Nm)
- 适用于 1/4" 外六角驱动的批头, 也适用于通过适配器的套筒扳手嵌件

7510 Kraftform Safe-Torque 快速扭矩扳手 · 1-3 Nm



Code	EAN	Hex Size	1.0 Nm	1.5 Nm	2.0 Nm	2.5 Nm	3.0 Nm	1
05075810001	230669	1/4"						

用于硬质合金嵌件的 7510/14 Safe-Torque 快速工具组套

14 件工具组套。用于专业螺丝刀/专业微调 and 扭矩控制螺丝刀。通过快速顺时针/逆时针设置和五个可选拧紧扭矩 (1.0; 1.5; 2.0; 2.5; 3.0 Nm) 和一个固定位置 (扭矩锁), 用于无限制的松开和拧紧扭矩。高强度的快速释放支架; 适用于 1/4" 外六角驱动批头。用于 TORX PLUS®、TORX® 和内六角螺丝的 14 个硬批头 (长 25 mm)。

工具组套特别适用于螺栓连接硬质合金嵌件。Safe-Torque Speed 7510 扭矩扳手具有领先的硬质合金工具制造商推荐的五个可选扭矩值, 确保可更换硬质合金刀杆的可靠扭矩控制螺纹连接。

- 尤其适合螺栓连接硬质合金嵌件
- 快速轻松地设置可选的拧紧扭矩 (1.0; 1.5; 2.0; 2.5; 3.0 Nm)
- 可以和其他 Wera 2go 系列产品组合使用

用于硬质合金嵌件的 7510/14 Safe-Torque 快速工具组套



Code	EAN	1
05075840001	230683	1
		7510 1x 1/4"x1,0 Nm/1,5 Nm/2,0 Nm/ 2,5 Nm/3,0 Nm x 147,5
		867/1 IP TORX PLUS® 1x 7 IPx25; 1x 8 IPx25; 1x 9 IPx25; 1x 10 IPx25; 1x 15 IPx25
		867/1 TORX® 1x TX 7x25; 1x TX 8x25; 1x TX 9x25; 1x TX 10x25; 1x TX 15x25
		840/1 Z 1x 2,0x25; 1x 2,5x25; 1x 3,0x25

7515 Kraftform Safe-Torque 快速扭矩扳手 · 2-6 Nm

- 可快速调整扭矩的扭力起子
- 轻松快速的扭矩设置
- 固定位置 (扭矩锁) 用于无限制的拧紧和松开扭矩
- 顺时针/逆时针扭矩控制的安全滑动扭矩功能
- 快速轻松地设置可选的拧紧扭矩 (2.0; 3.0; 4.0; 5.0; 6.0 Nm)
- 适用于 1/4" 外六角驱动的批头, 也适用于通过适配器的套筒扳手嵌件
- 适用于 1/4" 外六角驱动的批头, 也适用于通过适配器的套筒扳手嵌件

7515 Kraftform Safe-Torque 快速扭矩扳手 · 2-6 Nm



Code	EAN	批头	2,0 Nm	3,0 Nm	4,0 Nm	5,0 Nm	6,0 Nm	1
05075815001	228314	1/4"						

7515/16 Kraftform Safe-Torque 快速通用型 1

16 件工具组套。用于专业螺丝刀/专业微调扭矩控制螺丝刀。通过快速顺时针/逆时针设置和五个可选拧紧扭矩 (2.0; 3.0; 4.0; 5.0; 6.0 Nm) 和一个固定位置 (扭矩锁), 用于无限制的松开和拧紧扭矩。

高强度快速释放支架。适用于 1/4" 外六角驱动批头。15 个硬批头 (长 89 mm)。

- 可快速调整扭矩的扭力起子
- 快速轻松地设置可选的拧紧扭矩 (2.0; 3.0; 4.0; 5.0; 6.0 Nm)
- 可以和其他 Wera 2go 系列产品组合使用

7515/16 Kraftform Safe-Torque 快速通用型 1



Code	EAN	批头	1
05075851001	228338		
		7515 1x 1/4"x2,0 Nm/3,0 Nm/4,0 Nm/ 5,0 Nm/6,0 Nm x147,5	
		851/4 Z 1x PH 2x89	
		867/4 Z TORX® B0 1x TX 10x89; 1x TX 15x89; 1x TX 20x89; 1x TX 25x89; 1x TX 30x89	
		867/4 IP TORX PLUS® 1x 10 IPx89; 1x 15 IPx89; 1x 20 IPx89; 1x 25 IPx89; 1x 30 IPx89	
		840/4 Z 1x 3,0x89; 1x 4,0x89; 1x 5,0x89; 1x 6,0x89 ¹⁾	

¹⁾ 六角形刀片

7515/7 Kraftform Safe-Torque 快速自行车型 1

7 件工具组套。用于专业螺丝刀/专业微调扭矩控制螺丝刀。通过快速顺时针/逆时针设置和五个可选拧紧扭矩 (2.0; 3.0; 4.0; 5.0; 6.0 Nm) 和一个固定位置 (扭矩锁), 用于无限制的松开和拧紧扭矩。高强度快速释放支架。自行车操作的理想选择。适用于 1/4" 外六角驱动批头。

6 个硬批头 (50 mm 长), 采用 Take it easy 工具查找装置, 用特定颜色和标签代表不同端头尺寸, 以便快速查找所需工具。

- 自行车工具组套
- 可快速调整扭矩的扭力起子
- 快速轻松地设置可选的拧紧扭矩 (2.0; 3.0; 4.0; 5.0; 6.0 Nm)
- “易寻”色标系统: 用特定的颜色代表不同端头种类和尺寸
- 可以和其他 Wera 2go 系列产品组合使用

7515/7 Kraftform Safe-Torque 快速自行车型 1



Code	EAN		
05075850001	228321		1
		7515 1x 1/4"x2,0 Nm/3,0 Nm/4,0 Nm/ 5,0 Nm/6,0 Nm x147,5	
		867/4 TORX® BTZ 1x TX 10x50; 1x TX 25x50	
		840/4 BTZ 1x 2,5x50; 1x 3,0x50; 1x 4,0x50; 1x 5,0x50	

300 内六角定扭螺丝刀

维拉定扭螺丝刀在出厂前即按照推荐值设定好扭矩值。这些固定值主要依据 TORX® 螺丝、TORX PLUS® 螺丝和内六角螺丝的尺寸设定, 确保可简单安全地松开螺丝接头。精度: +/- 10 %。

超细的4mm六角刀身可处理难以进入位置的螺丝。

不可调式, 防止篡改。达到设定扭矩数值时可听到清晰的超负荷信号。

300 内六角定扭螺丝刀



	EAN	六角			六角	六角	六角	六角
Code	4013288	Nm	ft. lb.	mm	mm	mm	mm	
05027910001	096425	2,0	1,4	1,0	4	3,5	65	1
05027911001	096432	2,5	2,0	1,5	4	3,8	65	1
05027912001	096449	3,0	3,0	2,2	4	3,8	65	1

300 内六角定扭螺丝刀 · 枪形手柄

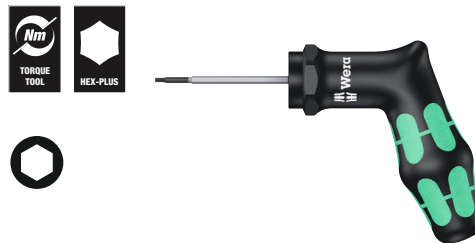

	EAN	六角			枪形手柄	枪形手柄	枪形手柄	枪形手柄
Code	4013288	Nm	ft. lb.	mm	mm	mm	mm	
05027913001	099150	4,0	5,0	3,7	160	100	65	1

300 TX TORX® 梅花定扭螺丝刀

- 用于TORX®梅花螺丝

300 TX TORX® 梅花定扭螺丝刀



	EAN	梅花			六角	六角	六角	六角
Code	4013288	Nm	ft. lb.	mm	mm	mm	mm	
05027930001	093325	TX 6	0,6	0,4	4	3,5	65	1
05027931001	093332	TX 7	0,9	0,7	4	3,5	65	1
05027932001	093349	TX 8	1,2	0,9	4	3,5	65	1
05027933001	093356	TX 9	1,4	1,0	4	3,5	65	1
05027934001	093370	TX 10	2,0	1,5	4	3,8	65	1
05027935001	093363	TX 15	3,0	2,2	4	3,8	65	1

300 TX TORX® 梅花定扭螺丝刀·枪形手柄



	EAN							
Code	4013288		Nm	ft.lb.	mm	mm	mm	
05027936001	099143	TX 20	5,0	3,7	160	100	65	1

300 IP TORX PLUS® 增强型梅花定扭螺丝刀

- 用于TORX PLUS®增强型梅花螺丝

300 IP TORX PLUS® 增强型梅花定扭螺丝刀



	EAN							
Code	4013288		Nm	ft. lb.	mm	mm	mm	
05028040001	093387	6 IP	0,6	0,4	4	3,5	65	1
05028041001	093394	7 IP	0,9	0,7	4	3,5	65	1
05028042001	093431	8 IP	1,2	0,9	4	3,5	65	1
05028043001	093400	9 IP	1,4	1,0	4	3,5	65	1
05028044001	093417	10 IP	2,0	1,5	4	3,8	65	1
05028045001	093424	15 IP	3,0	2,2	4	3,8	65	1

300 IP TORX PLUS® 增强型梅花定扭螺丝刀·枪形手柄



	EAN							
Code	4013288		Nm	ft.lb.	mm	mm	mm	
05028046001	099136	20 IP	5,0	3,7	160	100	65	1

400 内六角绝缘螺丝刀

维拉定扭螺丝刀有适用于六角螺丝帽和TORX®梅花螺丝的款式。定扭装置配有防盗设计。

耐用的空转设计会发出清晰的响声和触觉反馈, 以避免过度施加扭力。

松开螺丝时可是加的扭力并无制限, 所以在拆卸螺丝时不必要追加使用其他工具。

400 内六角绝缘螺丝刀



	EAN						
Code	4013288		Nm	mm	mm	mm	
05005080001	208835	4,0	4,0	60	48	100	2 3/8" 1
05005081001	208842	5,0	5,0	60	48	100	2 3/8" 1

400 TX 内六角绝缘螺丝刀

- 用于TORX®梅花螺丝

400 TX 内六角绝缘螺丝刀



	EAN							
Code	4013288		Nm	mm	mm	mm		
05005090001	208811	TX 20	4,0	60	48	100	2 3/8"	1
05005091001	208828	TX 25	5,0	60	48	100	2 3/8"	1

带 1/4" 方头驱动的 Safe-Torque A 1 扭矩扳手 · 2-12 Nm

带滑动机构的扭矩扳手。达到设定扭矩后, 不能对工具进行过度拧紧, 以免施加过度扭矩。

可换向矩控制运行设定范围为2-12 Nm。易于设置并保存默认数值: 达到刻度值时产生清晰的咔哒接触感, 有助于安全设置所需的扭矩值。

不带扭矩功能的标准棘轮使用扭矩锁功能。根据DIN 3122, 1/4" 方头的最大开断扭矩。只有 5° 的回转角允许棘轮即使在受限空间内也可以使用, 因此也适用于旋转角度的应用。

- 滑脱释放机构 - 设定扭矩切勿过度拧紧
- 扭矩锁定功能: 扭矩设定功能可以停用, 然后工具可用作具有高松动扭矩的标准棘轮, 并可用于具有规定旋转角度的应用程序
- 针对可控顺时针和逆时针扭矩操作 - 扭力设定可开关
- 易于设置和储存所需扭矩值, 当调到刻度值
- 工作舒适, 释放角度小 (仅30°)
- 1/4" 方头驱动, 带套筒锁定

带 1/4" 方头驱动的 Safe-Torque A 1 扭矩扳手 · 2-12 Nm



	EAN																
Code	4013288		Nm	Nm	lbf. ft.	mm	mm	mm	mm	mm							
0507580001	223012	1/4"	2-12	0,10	2-9	244	94	38,5	31,6	23,7	9 39/64"	3 45/64"	1 33/64"	1 15/64"	15/16"		1

带 1/4" 六角驱动的 Safe-Torque A 2 扭矩扳手 · 2-12 Nm

- 用于 1/4" 批头的 1/4" 六角驱动

带 1/4" 六角驱动的 Safe-Torque A 2 扭矩扳手 · 2-12 Nm



	EAN																
Code	4013288		Nm	Nm	lbf. ft.	mm	mm	mm	mm	mm							
05075801001	223036	1/4"	2-12	0,10	2-9	244	94	38,5	31,6	23,7	9 39/64"	3 45/64"	1 33/64"	1 15/64"	15/16"		1



Safe-Torque A 1 组套 1 · 1/4"方头 · 2-12 Nm

10 件 1/4" 扭矩扳手组套装入坚固的帆布工具袋内; 扭矩扳手带滑动机构。

达到设定扭矩后, 不能对工具进行过度拧紧, 以免施加过度扭矩。

可换向矩控制运行设定范围为2-12 Nm。

易于设置并保存默认数值: 达到刻度值时产生清晰的咔哒接触感, 有助于安全设置所需的扭矩值。不带扭矩功能的标准棘轮使用扭矩锁功能。因此, 也可用于旋转角度的应用。

根据DIN 3122, 1/4" 方头的最大开断扭矩。只有 5° 的回转角允许棘轮即使在受限空间内也可以使用。

含: Safe-Torque A 1个扭矩扳手, 方头1/4", 2-12 Nm, 8个套筒, 驱动1/4", 一根短延长杆。

- 1/4" 方头驱动, 带套筒锁定

Safe-Torque A 1 Imperial 组套 1 · 1/4" 方头 · 2-12 Nm

10 件 1/4" 扭矩扳手组套装入坚固的帆布工具袋内; 扭矩扳手带滑动机构。

达到设定扭矩后, 不能对工具进行过度拧紧, 以免施加过度扭矩。

可换向矩控制运行设定范围为2-12 Nm。

易于设置并保存默认数值: 达到刻度值时产生清晰的咔哒接触感, 有助于安全设置所需的扭矩值。不带扭矩功能的标准棘轮使用扭矩锁功能。因此, 也可用于旋转角度的应用。

根据DIN 3122, 1/4" 方头的最大开断扭矩。只有 5° 的回转角允许棘轮即使在受限空间内也可以使用。

含: Safe-Torque A 1个扭矩扳手, 方头1/4", 2-12 Nm, 8个套筒, 驱动1/4", 一根短延长杆。

- 1/4" 方头驱动, 带套筒锁定

Safe-Torque A 1 组套 1 · 1/4"方头 · 2-12 Nm



Code	EAN		
05075830001	223005		1
		<input type="checkbox"/> Safe-Torque A 1 1x 1/4", 2-12 Nm	
		<input checked="" type="checkbox"/> 8790 HMA 1x 5,5x23,0; 1x 6,0x23,0; 1x 7,0x23,0; 1x 8,0x23,0; 1x 10,0x23,0; 1x 11,0x23,0; 1x 12,0x23,0; 1x 13,0x23,0	
		<input checked="" type="checkbox"/> 8794 SA 1x 1/4"x75,0	
		魔术贴 240 1x 50,0x240,0	

Safe-Torque A 1 Imperial 组套 1 · 1/4" 方头 · 2-12 Nm



Code	EAN		
05075831001	223074		1
		<input type="checkbox"/> Safe-Torque A 1 1x 1/4", 2-12 Nm	
		<input checked="" type="checkbox"/> 8790 HMA 1x 9/16"x23,0; 1x 7/32"x23,0; 1x 1/4"x23,0; 1x 9/32"x23,0; 1x 5/16"x23,0; 1x 3/8"x23,0; 1x 7/16"x23,0; 1x 1/2"x23,0	
		<input checked="" type="checkbox"/> 8794 SA 1x 1/4"x75,0	
		魔术贴 240 1x 50,0x240,0	

Safe-Torque A 1 SHK 组套 1 · 1/4"方头 · 2-12 Nm

20 件组套, 含坚固置物盒, 特别适合暖通应用。一个带 1/4" 方头驱动的 Safe-Torque A 1 扭矩扳手, 2-12 Nm, 带滑动机构。达到设定扭矩后, 不能对工具进行过度拧紧, 以免施加过度扭矩。顺时针/逆时针转矩控制运行设定范围为2-12 Nm。

易于设置并保存默认数值: 达到刻度值时产生清晰的咔哒接触感, 有助于安全设置所需的扭矩值。具有扭矩锁定功能, 用作没有扭矩功能的标准棘轮, 因此也可用于具有旋转角度的应用。根据DIN 3122, 1/4" 方头的最大开断扭矩。只有 5° 的回转角允许棘轮即使在受限空间内也可以使用。

含: Safe-Torque A 1个扭矩扳手, 方头 1/4", 2-12 Nm, 8个套筒, 驱动1/4", 9个批头套筒 (内六角螺丝, TORX®), 驱动 1/4", 一根短加长件。

- 用于管道、供暖和空调操作, 特别是安装淋浴间以及组装和维护燃气锅炉和冷凝锅炉

Safe-Torque A 1 SHK 组套 1 · 1/4"方头 · 2-12 Nm



Code	EAN		
05136073001	4013288		1
		<input type="checkbox"/> Safe-Torque A 1 1x 1/4", 2-12 Nm	
		<input checked="" type="checkbox"/> 8790 HMA 1x 5,5x23,0; 1x 6,0x23,0; 1x 7,0x23,0; 1x 8,0x23,0; 1x 10,0x23,0; 1x 11,0x23,0; 1x 12,0x23,0; 1x 13,0x23,0	
		<input checked="" type="checkbox"/> 8767 A HF 1x TX 15x28,0; 1x TX 20x28,0; 1x TX 25x28,0; 1x TX 30x28,0	
		<input checked="" type="checkbox"/> 8740 A HF 1x 3,0x28,0; 1x 4,0x28,0; 1x 5,0x28,0; 1x 6,0x28,0; 1x 8,0x28,0	
		<input checked="" type="checkbox"/> Belt A 0/9 1x 39,0x238,0	
		<input checked="" type="checkbox"/> 8794 SA 1x 1/4"x75,0	
		魔术贴 240 1x 50,0x240,0	

Safe-Torque A 2 组套 1 · 1/4" 内六角 · 2-12 Nm

23 件组套; 收放于触感滑顺、节省空间且坚固耐用的帆布工具袋内。

尺寸小, 重量轻, 机动性好: 1 个 Safe-Torque A 2 扭矩扳手, 1/4" 内六角驱动, 扭矩设定范围2-12 Nm; 用于顺时针和逆时针方向的扭矩操作; 拧紧松动, 可开关式扭矩设定功能; 72齿; 5°回转角; 设定和保存所需扭矩值容易, 达到刻度值时有声音和触觉反馈, 达到设定扭矩时空转构造; 人体工学 双重材料手柄; 9 个 Zyklus 套筒, 12 个批头 (1/4", 50 mm 长), 套筒的一个插件 (1/4" 外六角至 1/4" 外四角)。

- 用于 1/4" 批头的 1/4" 六角驱动
- 通过维拉870/1转接头可接驳1/4"套筒

Safe-Torque A 2 组套 1 · 1/4" 内六角 · 2-12 Nm



Code	EAN		
05075832001	4013288		1
	223043	<input checked="" type="checkbox"/> Safe-Torque A 2 1x 1/4", 2-12 Nm	
		<input checked="" type="checkbox"/> 8790 HMA 1x 5,5x23,0; 1x 6,0x23,0; 1x 7,0x23,0; 1x 8,0x23,0; 1x 9,0x23,0; 1x 10,0x23,0; 1x 11,0x23,0; 1x 12,0x23,0; 1x 13,0x23,0	
		<input checked="" type="checkbox"/> 870/1 1x 1/4"x25 ¹⁾	
		<input checked="" type="checkbox"/> 851/4 Z 1x PH 2x50	
		<input checked="" type="checkbox"/> 867/4 Z TORX® 1x TX 10x50; 1x TX 15x50; 1x TX 20x50; 1x TX 25x50; 1x TX 27x50; 1x TX 30x50	
		<input checked="" type="checkbox"/> 840/4 Z 1x 2,5x50; 1x 3,0x50; 1x 4,0x50; 1x 5,0x50; 1x 6,0x50 ²⁾	
		魔术贴 240 1x 50,0x240,0	

¹⁾ 带摩擦球, 用于手动螺母扳手套筒
²⁾ 六角形刀片

Click-Torque A 5 换向式扭矩扳手

响声式扭矩扳手经过Wera独特可靠的工业设计以确保高精度，符合DIN EN ISO 6789-1: 2017-07标准，易于设置并保持原始默认数值。

当达到刻度值扭矩时，响声和触觉上的反馈也保障了所需扭矩值的安全设置。

稳定可靠的释放机制确保了达到预设扭矩时发出响声和触觉释放信号。适用于右手使用（顺时针扭矩控制），并带45齿可换向棘轮头。

- 带 $\frac{1}{4}$ "方头驱动和45齿可换向式棘轮头
- 测量范围 2.5-25 Nm； 读数精度为 $\pm 4\%$ ，符合DIN EN ISO 6789-1: 2017-07标准

Click-Torque A 5 换向式扭矩扳手 · 2,5-25 Nm



Code	EAN	Drive	Nm	Nm	lbf. ft.	mm	mm	mm	mm	mm	mm	mm	mm	mm	mm	mm	mm	mm	mm	mm	
05075604001	193179	$\frac{1}{4}$ "	2,5-25	0,10	1-18	290	121	42	25	11,5	11 $\frac{27}{64}$ "	4 $\frac{49}{64}$ "	1 $\frac{21}{32}$ "	1"	$\frac{7}{16}$ "						1

Click-Torque A 6 换向式扭矩扳手 · 2,5-25 Nm

- 带 $\frac{1}{4}$ "六方驱动和45齿可换向式棘轮头
- 测量范围 2.5-25 Nm； 读数精度为 $\pm 4\%$ ，符合DIN EN ISO 6789-1: 2017-07标准

Click-Torque A 6 换向式扭矩扳手 · 2,5-25 Nm



Code	EAN	Drive	Nm	Nm	lbf. ft.	mm	mm	mm	mm	mm	mm	mm	mm	mm	mm	mm	mm	mm	mm	mm	
05075605001	193186	$\frac{1}{4}$ "	2,5-25	0,10	1-18	290	121	42	25	11,5	11 $\frac{27}{64}$ "	4 $\frac{49}{64}$ "	1 $\frac{21}{32}$ "	1"	$\frac{7}{16}$ "						1

Click-Torque A 6 Set 1

Click torque系列扭矩扳手, 具有鲜明的Wera设计。

非常可靠的设计, 而且高精度, 符合 DIN EN ISO 6789-1: 2017-07标准, 易于设置和存储扭矩值。锁定时有声响和触觉反馈, 方便设置所需的扭矩。

可靠的释放机制能够确保 (使用过程中) 达到预设扭矩值时, 会有声响和触觉释放反馈信号。

可用于顺时针扭矩控制, 45齿棘轮机构。

Wera的Click torque扭矩扳手配合各种工具配件, 使之成为功能强大的套装。套装包括: 1支 Click Torque A6扭矩扳手 (1/4"凹六方驱动, 2.5Nm-25Nm), 6支套筒 (1/4"驱动), 11支 Hex-Plus 内六角, 十字PH和梅花TORX批头以及扩展和转接头配件。

Click-Torque A 6 Set 1 · 2,5-25 Nm



Code	EAN		
05130110001	4013288 205643		1
		Click-Torque A 6 1x 1/4", 2,5-25 Nm	
		851/4 TZ 1x PH 2x50	
		867/4 Z TORX® 1x TX 15x50; 1x TX 20x50; 1x TX 25x50; 1x TX 27x50; 1x TX 30x50; 1x TX 40x50	
		840/4 Z 1x 3,0x50; 1x 4,0x50; 1x 5,0x50; 1x 6,0x50 ¹⁾	
		870/1 1x 1/4"x25 ²⁾	
		8794 SA 1x 1/4"x75,0	
		8790 HMA 1x 6,0x23,0; 1x 7,0x23,0; 1x 8,0x23,0; 1x 10,0x23,0; 1x 12,0x23,0; 1x 13,0x23,0	
		魔术贴 240 1x 50,0x240,0	

¹⁾ 六角形刀片
²⁾ 带摩擦球, 用于手动螺母扳手套筒

自行车扭矩工具组套 1 · 2,5-25 Nm

维拉为自行车相关使用者设计的16件扭矩工具组套，可靠的扭矩设定使得相关零件收到妥善的保护。

内容包括源自维拉独特设计的Click-Torque咔哒扭力扳手，依据DIN EN ISO 6789-1: 2017-07耐用的设计和精确的扭力刻度计，简便的扭力调整装置。耐用的空转设计会发出清晰的响声和触觉反馈使得设定扭力值时更加安心方便，并且可以避免过度施加扭力。

附有顺时针的扭力调整装置和45细齿的棘轮头。卡达扭力扳手可以帮您节省空间且织布包组套内附带适合自行车用的套筒工具和扭矩调整范围。

组套内包括：Click-Torque咔哒扭力扳手 A5， $\frac{1}{4}$ "方形驱动，可调整扭力范围：2.5-25Nm，4个Zyklus套筒，4个增强型六角旋具套筒和7个TORX®梅花旋具套筒。

Zyklus套筒和旋具套筒带有"Take it Easy"易寻系统的颜色标识方便辨别尺寸，可轻松找到所需工具。附带加消磁器置放实用耐磨的组件夹。





带有固持功能的旋具套筒可以固持螺丝避免滑落使得操作起来更加方便安全。

令人惊艳的紧凑坚固的可携式织布包装可节省置放空间，并可保护工具表面不被刮花。

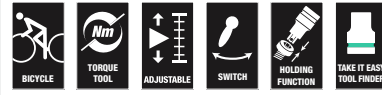
内含的旋具套筒集合了多项维拉的批头工艺，包括尺寸精度和耐磨技术等等。

自行车扭矩工具组套 1 · 2,5-25 Nm



Code	EAN		
05004180001	4013288 207685		 1
		Click-Torque A 5 1x $\frac{1}{4}$ " 2,5-25 Nm	
		 8790 HMA 1x 10,0x23,0; 1x 13,0x23,0; 1x 14,0x23,0; 1x 15,0x23,0	
		 8767 A 1x TX 10x28,0; 1x TX 20x28,0; 1x TX 25x28,0; 1x TX 30x28,0	
		 8740 A HF 1x 3,0x28,0; 1x 4,0x28,0; 1x 5,0x28,0; 1x 5,0x100,0; 1x 6,0x28,0; 1x 6,0x100,0; 1x 8,0x28,0	
		魔术贴 240 1x 50,0x240,0	

Click-Torque C 1 换向式扭矩扳手 · 10-50 Nm

- 带1/2"方头驱动和45齿可换向式棘轮头
- 测量范围 10-50 Nm; 读值精度为± 3%, 符合DIN EN ISO 6789-1: 2017-07标准
- Wera Click-Torque扭矩扳手外附有Click-Torque护套, 阻止颞口接触地面, 以免产生污垢和损坏

Click-Torque C 1 换向式扭矩扳手 · 10-50 Nm

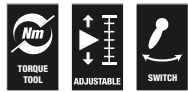

		EAN															
Code	4013288		Nm	Nm	lbf. ft.	mm	mm	mm	mm	mm							
05075620001	193216	1/2"	10-50	0,25	8-36	360	140	47	35	16,5	14 11/64"	5 33/64"	1 27/32"	1 3/8"	5/8"		1

Click-Torque C 2 换向式扭矩扳手 · 20-100 Nm

- 带1/2"方头驱动和45齿可换向式棘轮头
- 测量范围 20-100 Nm; 读值精度为± 3%, 符合DIN EN ISO 6789-1: 2017-07标准
- Wera Click-Torque扭矩扳手外附有Click-Torque护套, 阻止颞口接触地面, 以免产生污垢和损坏

Click-Torque C 2 换向式扭矩扳手 · 20-100 Nm



		EAN															
Code	4013288		Nm	Nm	lbf. ft.	mm	mm	mm	mm	mm							
05075621001	193223	1/2"	20-100	0,5	15-73	405	140	47	43	18,5	15 15/16"	5 33/64"	1 27/32"	1 11/16"	45/64"		1

Click-Torque C 3 Set 1 · 40-200 Nm

Click-Torque 咔哒扳手组套源自维拉独特的设计。

依据DIN EN ISO 6789-1: 2017-07耐用的设计和精确的扭力刻度计, 简便的扭力调整装置。

耐用的空转设计会发出清晰的响声和触觉反馈使得设定扭力值时更加安心方便, 并且可以避免过度施加扭力。

棘轮头拥有45细齿和换向拨杆, 此组套使用紧凑坚固且表面触感良好的织布包。

内含: Click Torque 咔哒扭力扳手C3 1/2"驱动球锁, 可调扭力范围40-200 Nm, 4个1/2"Zyklop套筒, 7个增强型六角和TORX®梅花旋具套筒, 附延长杆。

Click-Torque C 3 Set 1 · 40-200 Nm

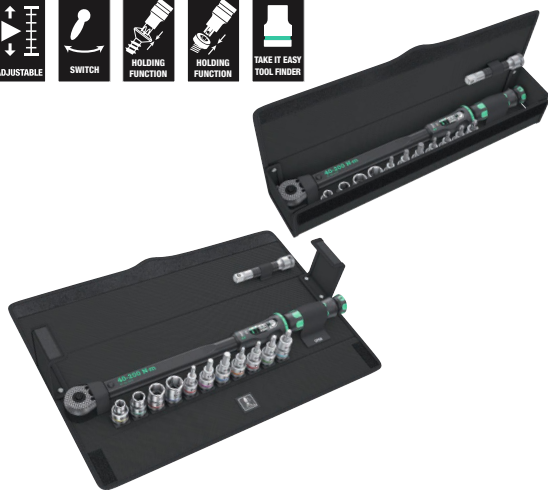

Code	EAN		
05075680001	4013288 207609		1
		Click-Torque C 3 1x 1/2", 40-200 Nm	
		● 8790 HMC 1x 10,0x37,0; 1x 13,0x37,0; 1x 17,0x37,0; 1x 19,0x37,0	
		✦ 8767 C HF 1x TX 30x60,0; 1x TX 40x60,0; 1x TX 45x60,0; 1x TX 50x60,0	
		○ 8740 C HF 1x 6,0x60,0; 1x 8,0x60,0; 1x 10,0x60,0	
		●○ 8794 SC 1x 1/2"x125,0	

Click-Torque C 3 套装 2 水泥工件作业, 40-200 Nm

11件水泥工件作业用工具套装。

适合根据螺钉制造商指导说明采用规定的扭矩安装和安全性能相关的水泥板螺钉。

'易寻'花形色标和尺寸标码系统- 可快速方便地找到所需工具。

- 适合根据螺钉制造商指导说明采用规定的扭矩安装和安全性能相关的水泥板螺钉
- 8790 C Impaktor 套筒扳手螺套, 用于采用12.5 mm = 1/2"英寸驱动头 (13 mm 至 21 mm)的通过压缩空气或电动驱动头的冲击型扳手应用
- Click-Torque C 3 扭矩扳手配备双向棘轮 (测量范围: 40-200 Nm; 精度 ± 3 % 根据 DIN EN ISO 6789-1: 2017-07)
- 11件套采用高级帆布工具盒

Click-Torque C 3 套装 2 水泥工件作业, 40-200 Nm



Code	EAN		
05075681001	4013288 217561		1
		Click-Torque C 3 1x 1/2", 40-200 Nm	
		● 8790 C Impaktor 1x 13,0x38,0; 1x 14,0x38,0; 1x 15,0x38,0; 1x 16,0x38,0; 1x 17,0x38,0; 1x 18,0x38,0; 1x 19,0x38,0; 1x 20,0x38,0; 1x 21,0x38,0	
		●○ 8894 SC 1x 1/2"x125,0	

Click-Torque C 4 换向式扭矩扳手 · 60-300 Nm

- 带 $\frac{1}{2}$ "方头驱动和45齿可换向式棘轮头
- 测量范围 60-300 Nm; 读值精度为 $\pm 3\%$, 符合DIN EN ISO 6789-1: 2017-07标准
- Wera Click-Torque扭矩扳手外附有Click-Torque护套, 防止颞口接触地面, 以免产生污垢和损坏

Click-Torque C 4 换向式扭矩扳手 · 60-300 Nm

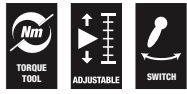

	EAN															
Code	4013288		Nm	Nm	lbf. ft.	mm	mm	mm	mm	mm						
05075623001	193247	$\frac{1}{2}$ "	60-300	1,0	45-220	595	140	47	43	18,5	$23 \frac{27}{64}$ "	$5 \frac{33}{64}$ "	$1 \frac{27}{32}$ "	$1 \frac{11}{16}$ "	$\frac{45}{64}$ "	1

Click-Torque C 5 换向式扭矩扳手 · 80-400 Nm

- 带 $\frac{1}{2}$ "方头驱动和45齿可换向式棘轮头
- 测量范围 80-400 Nm; 读值精度为 $\pm 3\%$, 符合DIN EN ISO 6789-1: 2017-07标准
- Wera Click-Torque扭矩扳手外附有Click-Torque护套, 防止颞口接触地面, 以免产生污垢和损坏

Click-Torque C 5 换向式扭矩扳手 · 80-400 Nm

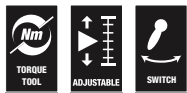

	EAN															
Code	4013288		Nm	Nm	lbf. ft.	mm	mm	mm	mm	mm						
05075624001	193254	$\frac{1}{2}$ "	80-400	1,0	60-295	680	140	47	43	18,5	$26 \frac{49}{64}$ "	$5 \frac{33}{64}$ "	$1 \frac{27}{32}$ "	$1 \frac{11}{16}$ "	$\frac{45}{64}$ "	1

Click-Torque E 1 换向式扭矩扳手 · 200-1000 Nm

- 带 $\frac{3}{4}$ "方头驱动和45齿可换向式棘轮头
- 测量范围 200-1000 Nm; 读值精度为 $\pm 3\%$, 符合DIN EN ISO 6789-1: 2017-07标准
- Wera Click-Torque扭矩扳手外附有Click-Torque护套, 防止颞口接触地面, 以免产生污垢和损坏

Click-Torque E 1 换向式扭矩扳手 · 200-1000 Nm

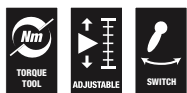

	EAN															
Code	4013288		Nm	Nm	lbf. ft.	mm	mm	mm	mm	mm						
05075630001	193261	$\frac{3}{4}$ "	200-1000	1,00	148-737	1250	140	47	63	30	$49 \frac{7}{32}$ "	$5 \frac{33}{64}$ "	$1 \frac{27}{32}$ "	$2 \frac{31}{64}$ "	$1 \frac{3}{16}$ "	1

Click-Torque 推杆式 R/L 可调扭矩扳手 · 用于顺时针和逆时针扭矩控制

Click-Torque 扳手, 采用精准无误的 维拉 设计。用于顺时针和逆时针扭矩控制。设计非常稳健, 精度高, 符合 DIN EN ISO 6789-1:2017-07。易于设置和保存默认值。达到刻度值时产生清晰的咔哒接触感, 有助于安全设置所需的扭矩值。达到设定扭矩时, 稳健的释放机构保证发出清晰的触觉释放信号。带固定式 3/4" 方头插件, 以改变方向。

1/2" 方头驱动器, 带套筒锁定。

- 牢固的方形驱动可平稳反转, 可进行顺时针和逆时针扭矩控制
- 测量范围 20-100 Nm; 读值精度为± 3%, 符合DIN EN ISO 6789-1: 2017-07标准
- 45 齿, 1/2" 方头驱动器, 带套筒锁紧
- 易于设置和储存所需扭矩值, 当调到刻度值
- 锁定时有声响和触觉反馈, 使用时达到预设扭矩值时, 会有响声和触觉释放反馈
- Wera Click-Torque扭矩扳手外附有Click-Torque护套, 阻止颞口接触地面, 以免产生污垢和损坏

Click-Torque C 2 Push R/L 推杆式可调扭矩扳手 · 用于顺时针和逆时针扭矩控制 · 20-100 Nm

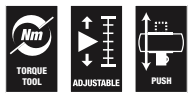

Code	EAN	□	Nm	Nm	lb. ft.	mm	mm	mm	mm	mm	mm	mm	mm	mm	mm	mm	mm	mm	mm	
05075625001	218926	1/2"	20-100	0,5	15-73	405	140	47	43	18,5	15 15/16"	5 33/64"	1 27/32"	1 11/16"	45/64"					1

Click-Torque C 3 Push R/L 推杆式可调扭矩扳手 · 用于顺时针和逆时针扭矩控制 · 40-200 Nm

- 测量范围 40-200 Nm; 读值精度为± 3%, 符合DIN EN ISO 6789-1: 2017-07标准
- 牢固的方形驱动可平稳反转, 可进行顺时针和逆时针扭矩控制
- 45 齿, 1/2" 方头驱动器, 带套筒锁紧
- Wera Click-Torque扭矩扳手外附有Click-Torque护套, 阻止颞口接触地面, 以免产生污垢和损坏

Click-Torque C 3 Push R/L 推杆式可调扭矩扳手 · 用于顺时针和逆时针扭矩控制 · 40-200 Nm

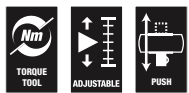

Code	EAN	□	Nm	Nm	lb. ft.	mm	mm	mm	mm	mm	mm	mm	mm	mm	mm	mm	mm	mm	mm	
05075626001	218933	1/2"	40-200	1,0	30-146	510	140	47	43	18,5	20 5/64"	5 33/64"	1 27/32"	1 11/16"	45/64"					1

Click-Torque E 1 Push R/L 推杆式可调扭矩扳手 · 用于顺时针和逆时针扭矩控制 · 200-1000 Nm

- 固定式方头插件可平稳反转, 可进行顺时针和逆时针扭矩控制
- 测量范围 200-1000 Nm; 读数精度为± 3%, 符合DIN EN ISO 6789-1: 2017-07标准
- 45 齿, 3/4" 方形驱动
- Wera Click-Torque扭矩扳手外附有Click-Torque护套, 防止颞口接触地面, 以免产生污垢和损坏

Click-Torque E 1 Push R/L 推杆式可调扭矩扳手 · 用于顺时针和逆时针扭矩控制 · 200-1000 Nm

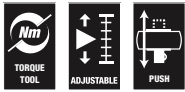

	EAN	□				⌘	⌘	⌘	⌘	⌘	⌘	⌘	⌘	⌘	⌘	⌘	⌘
Code	4013288		Nm	Nm	lbf. ft.	mm	mm	mm	mm	mm	mm	mm	mm	mm	mm	mm	mm
05075631001	219053	3/4"	200-1000	1,0	148-737	1250	140	47	63	30	49 7/32"	5 33/64"	1 27/32"	2 31/64"	1 3/16"		1

Click-Torque X 1 插换式扭矩扳手 · 2,5-25 Nm

响声式扭矩扳手, 经过Wera独特可靠的工业设计以确保高精度, 符合DIN EN ISO 6789-1: 2017-07标准, 易于设置并保持原始默认数值。当达到刻度值扭矩时, 响声和触觉反馈也保障了所需扭矩值的安全设置。

稳定可靠的释放机制确保了达到预设扭矩时发出响声和触觉释放信号。适用于右手使用(顺时针扭矩控制), 以及配有9 x 12mm插入式方头工具。

- 适用于9x12mm通用开口式工具
- 测量范围 2.5-25 Nm; 读数精度为± 4%, 符合DIN EN ISO 6789-1: 2017-07标准

Click-Torque X 1 插换式扭矩扳手 · 2,5-25 Nm



⌘	EAN	□				⌘	S _k	l _k	⌘	⌘	⌘	⌘	⌘	⌘	⌘	⌘	⌘
Code	4013288		Nm	Nm	lbf. ft.	mm	mm	mm	mm	mm	mm	mm	mm	mm	mm	mm	mm
05075651001	193773	9x12	2,5-25	0,10	1-18	292	17,5	240,0	121	42	24	20	11 9/64"	4 49/64"	1 21/32"	15/16"	1

¹⁾ S_k = 试验配件到支点的深度; l_k = 抓取位置到扭力测量点的范围

Click-Torque X 2 插换式扭矩扳手 · 10-50 Nm

- 适用于9x12mm通用开口式工具
- 测量范围 10-50 Nm; 读数精度为± 3%, 符合DIN EN ISO 6789-1: 2017-07标准
- Wera Click-Torque扭矩扳手外附有Click-Torque护套, 防止颞口接触地面, 以免产生污垢和损坏

Click-Torque X 2 插换式扭矩扳手 · 10-50 Nm



⌘	EAN	□				⌘	S _k	l _k	⌘	⌘	⌘	⌘	⌘	⌘	⌘	⌘	⌘
Code	4013288		Nm	Nm	lbf. ft.	mm	mm	mm	mm	mm	mm	mm	mm	mm	mm	mm	mm
05075652001	193797	9x12	10-50	0,25	8-36	338	17,5	285,0	140	47	29	20	13 5/16"	5 33/64"	1 27/32"	1 9/64"	1

¹⁾ S_k = 试验配件到支点的深度; l_k = 抓取位置到扭力测量点的范围

Click-Torque X 6 插换式扭矩扳手 · 80-400 Nm

- 设计: 适用于14x18mm通用开口式工具
- 测量范围 80-400 Nm; 读值精度为± 3%, 符合DIN EN ISO 6789-1: 2017-07标准
- Wera Click-Torque扭矩扳手外附有Click-Torque护套, 防止颞口接触地面, 以免产生污

Click-Torque X 6 插换式扭矩扳手 · 80-400 Nm



	EAN						S _k	l _k										
Code	4013288		Nm	Nm	lbf. ft.	mm	mm	mm	mm	mm	mm	mm	mm	mm	mm	mm	mm	
05075656001	193827	14x18	80-400	1,0	60-295	665	25,5	615,0	140	47	32	26	25 25/32"	5 33/64"	1 27/32"	1 17/64"	1	

* S_k = 试验配件到支点的深度; l_k = 抓取位置到扭力测量点的范围

Click-Torque X 7 用于嵌件工具的扭矩扳手 · 10-100 Nm

- 设计: 适用于14x18mm通用开口式工具
- 测量范围: 10-100 Nm; 精度 ± 4 % 根据 DIN EN ISO 6789-1:2017-07
- Wera Click-Torque扭矩扳手外附有Click-Torque护套, 防止颞口接触地面, 以免产生污垢和损坏, 防止打滑的危险
- 激光雕刻的耐磨二维码使得根据使用的扭矩扳手和嵌件工具确定正确的扭矩值变得更加容易

Click-Torque X 7 用于嵌件工具的扭矩扳手 · 10-100 Nm



	EAN						S _k	l _k										
Code	4013288		Nm	Nm	lbf. ft.	mm	mm	mm	mm	mm	mm	mm	mm	mm	mm	mm	mm	
05075657001	229335	14x18	10-100	0,5	8-73	395	25,5	343,0	140	47	29	20	14 41/64"	5 33/64"	1 27/32"	1 9/64"	1	

* S_k = 试验配件到支点的深度; l_k = 抓取位置到扭力测量点的范围

用于热泵/空调的 9530 扭矩扳手组套

4 件式 Click-Torque 扭矩扳手组套，带有三个自定义的 Joker 插入式扳手。用于在安装和维修制冷和空调系统以及热泵时正确拧紧螺丝连接。

Click-Torque 扳手，采用独特的 Wera 设计。设计非常稳健，精度高，符合 DIN EN ISO 6789-1:2017-07。

易于设置和保存默认值。达到刻度值时产生清晰的咔哒接触感，有助于安全设置所需的扭矩值。达到设定扭矩时，稳健的释放机构保证发出清晰的触觉释放信号。

用于顺时针和逆时针扭矩控制，并带有 14x18 mm 方头嵌件，用于安装相应的嵌件工具。

三个自定义的 Joker 7880 插入式扳手采用连续和平行钳口，可替代多个单规格扳手尺寸。

在将工具连接到六角螺栓或螺丝时，将自动和连续地设定所需尺寸。棘轮功能可确保快速一致的旋拧操作，且无需移开工具。使用角宽直角棱形体，可获得仅30°的反向旋转角度。

- 用于在安装和维修制冷和空调系统以及热泵时进行设置以正确拧紧螺丝连接
- Click-Torque X 7 扭矩扳手，带有可更换嵌件工具的支架 14x18 mm
- 测量范围: 10-100 Nm; 精度 $\pm 4\%$ 根据 DIN EN ISO 6789-1:2017-07
- 可调 7880 Joker 涵盖相应应用领域的全部公制和英制尺寸
- 自动和连续夹紧六角螺钉或螺栓
- 借助杠杆棘轮功能，无需取下扳手便可快速流畅完成螺丝紧固工序
- 激光雕刻的耐磨二维码使得根据使用的扭矩扳手和嵌件工具确定正确的扭矩值变得更加容易

用于热泵/空调的 9530 扭矩扳手组套



Code	EAN		
05136076001	4013288 228987		1
		Click-Torque X 7 1x 14x18, 10-100 Nm	
		7880 Joker XXL 1x 14x18x24-32x(1 ⁵ / ₁₆ "-1 1/4")x113,5	
		7880 Joker XL 1x 14x18x19-24x(3/4"-1 ⁵ / ₁₆ ")x95,0	
		7880 Joker L 1x 14x18x16-19x(5/8"-3/4")x85,5	

Click-Torque XP 1 响声式扭矩扳手, 适用于开口式工具 · 2,5-25 Nm · 2,5 Nm

扭矩扳手含预设扭矩值, 用于任何需要相同扭矩和重复精确度的应用。扭矩值可在测量范围内改变。达到设定扭矩时, 稳健的释放机构保证发出清晰的触觉释放信号。

内四角套筒用于可更换插件工具, 用于顺时针和逆时针扭矩控制。根据要求, 可以从该值偏离到指定测量范围内所需的扭矩值。

- 驱动端方形套(9x12 mm)筒适用于所有可交换式插头且正逆时钟可同时空转。
- Click-Torque预制式咔哒定扭扳手出自于维拉独特的设计
- 测量范围 2.5-25 Nm; 读值精度为± 2%, 符合DIN EN ISO 6789-1: 2017-07标准
- 在维拉可设置和调整的范围内在校正所为您预制扭力

Click-Torque XP 1 响声式扭矩扳手, 适用于开口式工具 · 2,5-25 Nm · 2,5 Nm



Code	EAN	□	Scale			S _k	l _k	Screw		□	□	□	□	□	□	□	□	□
			Nm	Nm	lbf. ft.			mm	mm									
05075670001	206169	9x12	2,5	2,5-25	2-18	217	17,5	180,0	137	35	24	20	8 35/64"	5 25/64"	1 3/8"	15/16"	1	
05075670101 ¹⁾	206206	9x12	2,5	2,5-25	2-18	217	17,5	180,0	137	35	24	20	8 35/64"	5 25/64"	1 3/8"	15/16"	1	

¹⁾ 在维拉可设置和调整的范围内在校正所为您预制扭力。所需设置可以用以下单位表示: Nm, kgf.m, lbf.ft., ozf.in., dN.m, kgf.cm, lbf.in., in.oz, cN.m, gf.m, ft.lb, gf.cm, in. lb.

²⁾ S_k = 试验配件到支点的深度; l_k = 抓取位置到扭力测量点的范围

Click-Torque XP 2 响声式扭矩扳手, 适用于开口式工具 · 10-50 Nm · 10 Nm

- 驱动端方形套(9x12 mm)筒适用于所有可交换式插头且正逆时钟可同时空转。
- 测量范围 10-50 Nm; 读值精度为± 2%, 符合DIN EN ISO 6789-1: 2017-07标准
- 在维拉可设置和调整的范围内在校正所为您预制扭力

Click-Torque XP 2 响声式扭矩扳手, 适用于开口式工具 · 10-50 Nm · 10 Nm



Code	EAN	□	Scale			S _k	l _k	Screw		□	□	□	□	□	□	□	□	□
			Nm	Nm	lbf. ft.			mm	mm									
05075671001	206176	9x12	10,0	10-50	8-36	262	17,5	225,0	137	35	24	20	10 5/16"	5 25/64"	1 3/8"	15/16"	1	
05075671010 ¹⁾	206213	9x12	10,0	10-50	8-36	262	17,5	225,0	137	35	24	20	10 5/16"	5 25/64"	1 3/8"	15/16"	1	

¹⁾ 在维拉可设置和调整的范围内在校正所为您预制扭力。所需设置可以用以下单位表示: Nm, kgf.m, lbf.ft., ozf.in., dN.m, kgf.cm, lbf.in., in.oz, cN.m, gf.m, ft.lb, gf.cm, in. lb.

²⁾ S_k = 试验配件到支点的深度; l_k = 抓取位置到扭力测量点的范围

Click-Torque XP 3 响声式扭矩扳手, 适用于开口式工具 · 15-100 Nm · 15 Nm

- 驱动端方形套(9x12 mm)筒适用于所有可交换式插头且正逆时针可同时空转。
- 测量范围 15-100 Nm; 读值精度为± 2%, 符合DIN EN ISO 6789-1: 2017-07标准
- 在维拉可设置和调整的范围内在校正所为您预制扭力

Click-Torque XP 3 响声式扭矩扳手, 适用于开口式工具 · 15-100 Nm · 15 Nm



●		EAN	□				S _k		l _k		□		□		□		□		□	
Code		4013288		Nm	Nm	lbf. ft.	mm	mm	mm	mm	mm	mm	mm	mm	mm	mm	mm	mm	mm	mm
05075672001		206183	9x12	15,0	15-100	11-74	332	17,5	296,0	137	35	24	20	13 5/64"	5 25/64"	1 3/8"	15/16"	1		
05075672010 ¹⁾		207999	9x12	15,0	15-100	11-74	332	17,5	296,0	137	35	24	20	13 5/64"	5 25/64"	1 3/8"	15/16"	1		

¹⁾ 在维拉可设置和调整的范围内在校正所为您预制扭力。所需设置可以用以下单位表示: Nm, kgf.m, lbf.ft., ozf.in., dN.m, kgf.cm, lbf.in, in.oz, cN.m, gf.m, ft.lb, gf.cm, in. lb.

²⁾ S_k = 试验配件到支点的深度; l_k = 抓取位置到扭力测量点的范围

Click-Torque XP 4 响声式扭矩扳手, 适用于开口式工具 · 20-250 Nm · 20 Nm

- 驱动端方形套(14x18 mm)筒适用于所有可交换式插头且正逆时针可同时空转。
- 测量范围 20-250 Nm; 读值精度为± 2%, 符合DIN EN ISO 6789-1: 2017-07标准
- 在维拉可设置和调整的范围内在校正所为您预制扭力
- Wera Click-Torque扭矩扳手外附有Click-Torque护套, 阻止颞口接触地面, 以免产生污

Click-Torque XP 4 响声式扭矩扳手, 适用于开口式工具 · 20-250 Nm · 20 Nm



●		EAN	□				S _k		l _k		□		□		□		□		□	
Code		4013288		Nm	Nm	lbf. ft.	mm	mm	mm	mm	mm	mm	mm	mm	mm	mm	mm	mm	mm	mm
05075673001		206190	14x18	20,0	20-250	15-184	457	25,5	430,0	145	41	32	26	17 63/64"	5 45/64"	1 39/64"	1 17/64"	1		
05075673010 ¹⁾		206220	14x18	20,0	20-250	15-184	457	25,5	430,0	145	41	32	26	17 63/64"	5 45/64"	1 39/64"	1 17/64"	1		

¹⁾ 在维拉可设置和调整的范围内在校正所为您预制扭力。所需设置可以用以下单位表示: Nm, kgf.m, lbf.ft., ozf.in., dN.m, kgf.cm, lbf.in, in.oz, cN.m, gf.m, ft.lb, gf.cm, in. lb.

²⁾ S_k = 试验配件到支点的深度; l_k = 抓取位置到扭力测量点的范围

新

简单无误地确定 扭矩值

激光雕刻的耐磨二维码使得根据使用的扭矩扳手和嵌件工具确定正确的扭矩值变得更加容易。只需用智能手机和平板电脑扫描 (如果有, 两个二维码: 扭矩扳手和嵌件工具)。网站会自动打开, 识别扫描的工具 (无需应用程序!)。然后输入所需的扭矩值; 校正值是自动确定的。不需要使用公式/计算。



www.wera.de/torque-advisor

7880 Joker XXL 自定位插入式扳手 · 适用于尺寸为 24-32 mm、14x18 mm 的扳手

- 适用于响声式扭矩扳手X系列, 驱动 14x18mm
- 可调 7880 Joker 涵盖相应应用领域的所有公制和英制尺寸
- 自动和连续夹紧六角螺钉或螺栓
- 握紧时通过杠杆机构, 避免滑脱和产生损坏
- 借助杠杆棘轮功能, 无需取下扳手便可快速流畅完成螺丝紧固工序
- 开口凹槽设计实现 30° 回转角
- 激光雕刻的耐磨二维码使得根据使用的扭矩扳手和嵌件工具确定正确的扭矩值变得更加容易

7880 Joker XXL 自定位插入式扳手 · 适用于尺寸为 24-32 mm、14x18 mm 的扳手

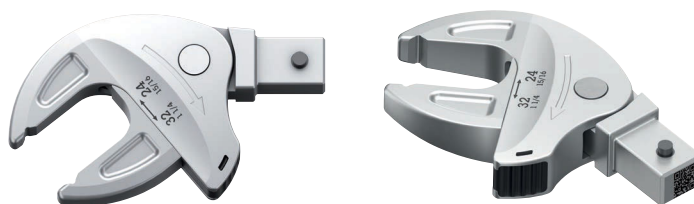

	EAN	□									
Code	4013288	mm	mm	mm	mm	mm	mm	mm	mm	mm	
05020173001	229380	14x18	24-32	15/16"-1 1/4"	24,0 27,0 30,0 32,0	62,2 68,0 70,2 70,4	15/16" 31/32" 1" 1 1/16" 1 1/8" 1 3/16" 1 1/4"	62,2 63,9 65,4 66,4 69,5 70,1 70,2	113,5	1	

7880 Joker XL 自定位插入式扳手 · 适用于尺寸为 19-24 mm、14x18 mm 的扳手

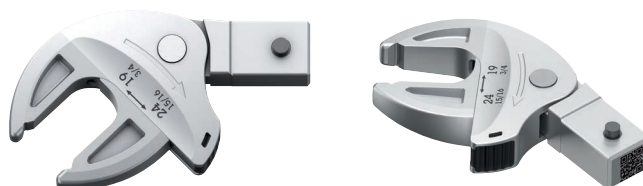

	EAN	□									
Code	4013288	mm	mm	mm	mm	mm	mm	mm	mm	mm	
05020172001	229366	14x18	19-24	19,0 20,0 21,0 22,0 24,0	51,6 53,6 55,4 56,7 56,7	3/4" 25/32" 13/16" 7/8" 15/16"	51,6 53,3 54,7 56,7 56,7	3/4"-15/16"	95	1	

7880 Joker L 自定位插入式扳手 · 适用于尺寸为 16-19 mm、14x18 mm 的扳手

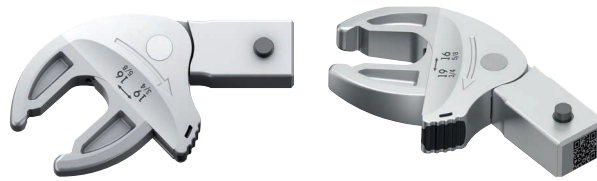

	EAN									
Code	4013288	mm	mm		mm			mm	mm	
05020171001	229359	14x18	16-19	5/8"-3/4"	16,0 17,0 18,0 19,0	44,6 46,7 48,2 49,1	5/8" 11/16" 3/4"	44,4 47,3 49,1	85,5	1

7770 开口扳手插头, 9x12 mm

- 开口式工具 9x12 mm
- 适用于响声式扭矩扳手X 系列, 驱动 9x12 mm
- 应用: 六角螺栓、螺母
- 配有安全插销
- 铬钒钢使得插入工具非常适合高负荷作业

7770 开口扳手插头, 9x12 mm

规格 A
 05078600001
 05078601001
 05078602001
 05078603001
 05078604001
 05078605001



规格 B
 05078606001
 05078607001
 05078608001
 05078609001
 05078610001
 05078611001
 05078612001



	EAN								
Code	4013288	mm	mm	mm	mm	mm	mm	mm	
05078600001	196101	9x12	7	17,5	39,0	22,0	22,0	5,0	1
05078601001	196095	9x12	8	17,5	39,0	22,0	22,0	5,0	1
05078602001	196088	9x12	9	17,5	39,0	22,0	22,0	5,0	1
05078603001	196071	9x12	10	17,5	39,0	22,0	22,0	5,0	1
05078604001	196064	9x12	11	17,5	39,0	22,0	22,0	5,0	1
05078605001	196057	9x12	12	17,5	39,0	22,0	22,0	5,0	1
05078606001	196040	9x12	13	17,5	41,0	24,0	30,0	7,0	1
05078607001	196033	9x12	14	17,5	41,0	24,0	30,0	7,0	1
05078608001	196026	9x12	15	17,5	41,0	24,0	30,0	7,0	1
05078609001	196019	9x12	16	17,5	41,0	24,0	30,0	7,0	1
05078610001	196002	9x12	17	17,5	41,0	24,0	30,0	7,0	1
05078611001	196118	9x12	18	17,5	41,0	24,0	30,0	7,0	1
05078612001	196125	9x12	19	17,5	41,0	24,0	30,0	7,0	1

7780 开口扳手插头, 14x18 mm

开口扳手插头, 六角螺栓、螺母, 14x18mm, 适用于响声式扭矩扳手X系列。

7780 开口扳手插头, 14x18 mm

规格 A

05078670001



规格 B

05078671001
05078672001
05078673001
05078674001
05078675001
05078676001



规格 C

05078677001
05078678001
05078679001
05078680001
05078681001



规格 D

05078682001
05078683001
05078684001
05078685001
05078686001
05078687001



	EAN									
Code	4013288	mm	mm	mm	mm	mm	mm	mm	mm	
05078670001	196729	14x18	13	25,5	56,0	32,0	30,0	7,0	1	
05078671001	196736	14x18	14	25,5	58,0	33,0	32,0	8,0	1	
05078672001	196743	14x18	15	25,5	58,0	33,0	32,0	8,0	1	
05078673001	196750	14x18	16	25,5	58,0	33,0	32,0	9,0	1	
05078674001	196767	14x18	17	25,5	58,0	33,0	32,0	9,0	1	
05078675001	196774	14x18	18	25,5	58,0	33,0	32,0	9,7	1	
05078676001	196781	14x18	19	25,5	58,0	33,0	32,0	9,7	1	
05078677001	196798	14x18	21	25,5	61,0	36,0	52,0	11,0	1	
05078678001	196804	14x18	22	25,5	61,0	36,0	52,0	11,0	1	
05078679001	196811	14x18	24	27,5	61,0	36,0	52,0	12,0	1	
05078680001	196828	14x18	26	30,0	61,0	36,0	52,0	13,0	1	
05078681001	196835	14x18	27	30,0	61,0	36,0	52,0	13,0	1	
05078682001	196842	14x18	29	30,0	61,0	36,0	52,0	14,0	1	
05078683001	196859	14x18	30	30,0	61,0	36,0	52,0	14,0	1	
05078684001	196866	14x18	32	32,5	61,0	36,0	52,0	14,0	1	
05078685001	196873	14x18	36	32,5	61,0	36,0	52,0	15,0	1	
05078686001	196880	14x18	38	32,5	61,0	36,0	52,0	15,0	1	
05078687001	196897	14x18	41	32,5	61,0	36,0	52,0	15,0	1	

7771 环形扳手插头, 9x12 mm

梅花扳手插头, 六角螺栓、螺母, 9x12mm, 适用于响声式扭矩扳手X 系列。

7771 环形扳手插头, 9x12 mm

规格 A

05078620001
05078621001
05078622001
05078623001
05078624001



规格 B

05078625001
05078626001
05078627001
05078628001
05078629001
05078630001
05078631001
05078632001



规格 C

05078633001



	EAN									
Code	4013288	mm	mm	mm	mm	mm	mm	mm	mm	
05078620001	196163	9x12	7	17,5	41,0	24,0	22,0	8,0	1	
05078621001	196156	9x12	8	17,5	41,0	24,0	22,0	8,0	1	
05078622001	196170	9x12	9	17,5	41,0	24,0	22,0	8,0	1	
05078623001	196187	9x12	10	17,5	41,0	24,0	22,0	8,0	1	
05078624001	196194	9x12	11	17,5	41,0	24,0	22,0	8,0	1	
05078625001	196200	9x12	12	17,5	44,0	27,0	22,0	11,0	1	
05078626001	196217	9x12	13	17,5	44,0	27,0	22,0	11,0	1	
05078627001	196224	9x12	14	17,5	44,0	27,0	22,0	11,0	1	
05078628001	196231	9x12	15	17,5	44,0	27,0	22,0	11,0	1	
05078629001	196248	9x12	16	17,5	44,0	27,0	22,0	11,0	1	
05078630001	196255	9x12	17	17,5	44,0	27,0	22,0	11,0	1	
05078631001	196262	9x12	18	17,5	44,0	27,0	22,0	11,0	1	
05078632001	196279	9x12	19	17,5	44,0	27,0	22,0	11,0	1	
05078633001	196286	9x12	21	17,5	51,0	34,0	33,0	15,0	1	

7781 环形扳手插头, 14x18 mm

梅花扳手插头, 六角螺栓、螺母, 14x18mm, 适用于响声式扭矩扳手X 系列。

7781 环形扳手插头, 14x18 mm

规格 A

05078690001
05078691001
05078692001



规格 B

05078693001
05078694001
05078695001
05078696001
05078697001
05078698001
05078699001



规格 C

05078700001
05078701001
05078702001
05078703001
05078704001
05078705001



	EAN									
Code	4013288	mm	mm	mm	mm	mm	mm	mm	mm	
05078690001	196132	14x18	13	25,5	62,0	37,0	30,0	11,0	1	
05078691001	196576	14x18	14	25,5	62,0	37,0	30,0	11,0	1	
05078692001	196583	14x18	15	25,5	62,0	37,0	30,0	11,0	1	
05078693001	196590	14x18	16	25,5	64,0	39,0	28,0	12,0	1	
05078694001	196606	14x18	17	25,5	64,0	39,0	28,0	12,0	1	
05078695001	196620	14x18	18	25,5	64,0	39,0	28,0	12,0	1	
05078696001	196637	14x18	19	25,5	64,0	39,0	28,0	12,0	1	
05078697001	196644	14x18	21	25,5	64,0	39,0	28,0	12,0	1	
05078698001	196613	14x18	22	25,5	64,0	39,0	28,0	12,0	1	
05078699001	196651	14x18	24	25,5	64,0	39,0	28,0	12,0	1	
05078700001	196668	14x18	27	25,5	81,0	56,0	53,0	21,0	1	
05078701001	196675	14x18	30	25,5	81,0	56,0	53,0	21,0	1	
05078702001	196682	14x18	32	25,5	81,0	56,0	53,0	21,0	1	
05078703001	196699	14x18	34	28,0	81,0	56,0	53,0	21,0	1	
05078704001	196705	14x18	36	28,0	81,0	56,0	53,0	21,0	1	
05078705001	196712	14x18	41	30,0	81,0	56,0	53,0	21,0	1	

7772 A 可换向式棘轮头, 9x12 mm

可换向式棘轮头, 适用于1/4"四方驱动或驱动转接头, 9x12mm, 适用于响声式扭矩扳手X系列。

7772 A 可换向式棘轮头, 9x12 mm



	EAN									
Code	4013288	mm		mm	mm	mm	mm	mm	mm	
05078635001	196347	9x12		1/4"	17,5	49,0	32,0	28,0	15,0	1

7772 B 可换向式棘轮头, 9x12 mm

可换向式棘轮头, 适用于3/8"四方驱动或驱动转接头, 9x12mm, 适用于响声式扭矩扳手X系列。

7772 B 可换向式棘轮头, 9x12 mm



	EAN									
Code	4013288	mm		mm	mm	mm	mm	mm	mm	
05078636001	196446	9x12		3/8"	17,5	52,0	35,0	35,0	21,0	1

7772 C 可换向式棘轮头, 9x12 mm

可换向式棘轮头, 适用于1/2"四方驱动或驱动转接头, 9x12mm, 适用于响声式扭矩扳手X系列。

7772 C 可换向式棘轮头, 9x12 mm



	EAN									
Code	4013288	mm		mm	mm	mm	mm	mm	mm	
05078637001	196453	9x12		1/2"	20,0	58,0	41,0	42,0	23,0	1

7782 C 可换向式棘轮头, 14x18 mm

可换向式棘轮头, 适用于1/2"四方驱动或驱动转换头, 14x18mm, 适用于响声式扭矩扳手X系列。

7782 C 可换向式棘轮头, 14x18 mm



	EAN									
Code	4013288	mm		mm	mm	mm	mm	mm	mm	
05078707001	196552	14x18	1/2"	20,0	66,0	41,0	42,0	23,0		1

7782 E 可换向式棘轮头, 14x18 mm

可换向式棘轮头, 适用于3/4"四方驱动或驱动转换头, 14x18mm, 适用于响声式扭矩扳手X系列。

7782 E 可换向式棘轮头, 14x18 mm



	EAN									
Code	4013288	mm		mm	mm	mm	mm	mm	mm	
05078708001	196569	14x18	3/4"	30,0	90,0	65,0	65,0	36,0		1

7773 A 扭矩扳手头, 9x12 mm

扭矩扳手头, 适用于1/4"四方驱动套筒, 及1/2"驱动转换头, 响声式扭矩扳手X系列, 带9x12mm插槽。

7773 A 扭矩扳手头, 9x12 mm



	EAN									
Code	4013288	mm		mm	mm	mm	mm	mm	mm	
05078200001	023742	9x12	1/4"	17,5	44,0	28,0	21,0	14,0		1

7773 B 扭矩扳手头, 9x12 mm

扭矩扳手头, 适用于 3/8"四方驱动套筒, 及 3/8"驱动转换头, 响声式扭矩扳手X系列, 带9x12mm插槽。

7773 B 扭矩扳手头, 9x12 mm



	EAN								
Code	4013288	mm		mm	mm	mm			
05078205001	023759	9x12	3/8"	17,5	44,0	28,0	21,0	14,0	1

7773 C 扭矩扳手头, 9x12 mm

扭矩扳手头, 适用于 1/2"四方驱动套筒, 及 1/2"驱动转换头, 响声式扭矩扳手X系列, 带9x12mm插槽。

7773 C 扭矩扳手头, 9x12 mm



	EAN								
Code	4013288	mm		mm	mm	mm	mm	mm	
05078210001	023766	9x12	1/2"	17,5	44,0	28,0	21,0	14,0	1

7783 C 扭矩扳手头, 14x18 mm

内四角驱动, 用于 1/2" 内四角扳手嵌件和 1/2" 连接部件和内四角驱动; 用于 Click-Torque X 系列扭矩扳手和 14x18 mm 接头。

7783 C 扭矩扳手头, 14x18 mm



	EAN								
Code	4013288	mm		mm	mm	mm	mm	mm	
05078345001	024183	14x18	1/2"	25,5	65,0	40,0	30,0	18,0	1

7783 E 推杆式四方驱动插头, 14x18 mm

扭矩扳手头, 适用于 $\frac{3}{4}$ "四方驱动套筒, 及 $\frac{3}{4}$ "驱动转换头, 响声式扭矩扳手X系列, 带14x18mm插槽。

7783 E 推杆式四方驱动插头, 14x18 mm



	EAN									
Code	4013288	mm		mm	mm	mm	mm	mm	mm	
05078710001	196460	14x18	$\frac{3}{4}$ "	25,5	70,0	45,0	40,0	25,0		1

7774/1 $\frac{1}{4}$ "批头接驳用插头, 9x12 mm

$\frac{1}{4}$ "批头适配插头, 响声式扭矩扳手X系列, 带9x12mm插槽。

7774/1 $\frac{1}{4}$ "批头接驳用插头, 9x12 mm



	EAN									
Code	4013288	mm		mm	mm	mm	mm	mm	mm	
05078640001	196316	9x12	$\frac{1}{4}$ "	17,5	42,0	25,0	22,0	12,5		1

7774/2 $\frac{5}{16}$ "批头接驳用插头, 9x12 mm

$\frac{5}{16}$ "批头适配插头, 响声式扭矩扳手X系列, 带9x12mm插槽。

7774/2 $\frac{5}{16}$ "批头接驳用插头, 9x12 mm



	EAN									
Code	4013288	mm		mm	mm	mm	mm	mm	mm	
05078641001	196309	9x12	$\frac{5}{16}$ "	17,5	42,0	25,0	22,0	12,5		1

7774/3 5/16"批头接驳用插头, 14x18 mm

5/16"批头适配插头, 响声式扭矩扳手X系列, 带14x18mm插槽。

7774/3 5/16"批头接驳用插头, 14x18 mm



	EAN									
Code	4013288	mm		mm	mm	mm	mm	mm	mm	
05078642001	196293	14x18	5/16"	25,5	58,0	33,0	30,0	13,0	1	

7775 环形开口扳手插头, 9x12 mm

梅花开口扳手插头, 角螺栓、螺母, 响声式扭矩扳手X系列, 带9x12mm插槽。

7775 环形开口扳手插头, 9x12 mm

规格 A

- 05078650001
- 05078651001
- 05078652001
- 05078653001
- 05078654001
- 05078655001



规格 B

- 05078656001
- 05078657001
- 05078658001



	EAN									
Code	4013288	mm	mm	mm	mm	mm	mm	mm	mm	
05078650001	196330	9x12	10	17,5	44,0	27,0	22,0	11,0	1	
05078651001	196361	9x12	11	17,5	44,0	27,0	22,0	11,0	1	
05078652001	196378	9x12	12	17,5	44,0	27,0	22,0	11,0	1	
05078653001	196385	9x12	13	17,5	44,0	27,0	22,0	11,0	1	
05078654001	196392	9x12	14	17,5	44,0	27,0	22,0	11,0	1	
05078655001	196408	9x12	17	17,5	44,0	27,0	22,0	11,0	1	
05078656001	196415	9x12	18	17,5	49,0	32,0	33,0	15,0	1	
05078657001	196422	9x12	19	17,5	49,0	32,0	33,0	15,0	1	
05078658001	196439	9x12	22	17,5	49,0	32,0	33,0	15,0	1	

7776 TORX®外梅花插头, 9x12 mm

外梅花TORX®插头, 螺母, 响声式扭矩扳手X系列, 带9x12mm插槽。

7776 TORX®外梅花插头, 9x12 mm

规格 A

- 05078660001
- 05078661001
- 05078662001
- 05078663001



规格 B

- 05078664001



	EAN									
Code	4013288	mm		mm	mm	mm	mm	mm	mm	
05078660001	195968	9x12	TX 6	17,5	40,0	23,0	22,0	8,0	1	
05078661001	195975	9x12	TX 8	17,5	40,0	23,0	22,0	8,0	1	
05078662001	195982	9x12	TX 10	17,5	40,0	23,0	22,0	8,0	1	
05078663001	195999	9x12	TX 12	17,5	40,0	23,0	22,0	8,0	1	
05078664001	196149	9x12	TX 14	17,5	45,0	28,0	22,0	11,0	1	

7786 TORX®外梅花插头, 14x18 mm

外梅花TORX®插头, 螺母, 响声式扭矩扳手X系列, 带14x18mm插槽。

7786 TORX®外梅花插头, 14x18 mm

规格 **A**
05078714001
05078715001



规格 **B**
05078716001
05078717001



	EAN									
Code	4013288	mm		mm	mm	mm	mm	mm	mm	
05078714001	196507	14x18	TX 14	25,5	37,0	62,0	30,0	11,0	1	
05078715001	196514	14x18	TX 18	25,5	37,0	62,0	30,0	11,0	1	
05078716001	196521	14x18	TX 20	25,5	40,0	65,0	32,0	12,0	1	
05078717001	196538	14x18	TX 24	25,5	40,0	65,0	32,0	12,0	1	

7779/1 转接头, 9x12 mm

适配插头, 适用于四方14x18mm插入工具, 带四方插槽9x12mm的扭矩扳手, 9x12mm,适用于响声式扭矩扳手X系列。

7779/1 转接头, 9x12 mm



	EAN								
Code	4013288	mm	mm	mm	mm	mm	mm	mm	
05078666001	196323	9x12	14x18	49,0	33,0	32,0	26,0	1	

7779/2 转接头, 14x18 mm

适配插头, 适用于四方9x12mm插入工具, 带四方插槽14x18mm的扭矩扳手, 14x18mm,适用于响声式扭矩扳手X系列。

7779/2 转接头, 14x18 mm



	EAN								
Code	4013288	mm	mm	mm	mm	mm	mm	mm	
05078667001	196545	14x18	9x12	52,0	27,0	28,0	21,0	1	







7790/1 焊用插头, 9x12 mm

焊接适配器, 9x12mm,适用于响声式扭矩扳手X 系列。

- 适合于焊接特殊要求的工具
- 理想情况下, 焊接应由专业焊接公司进行

7790/1 焊用插头, 9x12 mm



	EAN						
Code	4013288	mm	mm	mm	mm	mm	
05078720001	196354	9x12	24,0	8,0	22,0	14,0	1







7790/2 焊用插头, 14x18 mm

焊接适配器, 14x18mm,适用于响声式扭矩扳手X 系列。

- 适合于焊接特殊要求的工具
- 理想情况下, 焊接应由专业焊接公司进行

7790/2 焊用插头, 14x18 mm



	EAN						
Code	4013288	mm	mm	mm	mm	mm	
05078721001	196477	14x18	38,0	13,0	31,0	22,0	1

7761 Click-Torque 衬套1

压环可防止Click-Torque扭矩扳手的手柄撞击地面。

在操作过程中,可避免在将工具置放时可能产生的脏污和损坏。

同时还可防止工具滚动,并将Click-Torque扭矩扳手固定在存放/携带盒内。压环可轻松连接到扭矩扳手,且可移除。

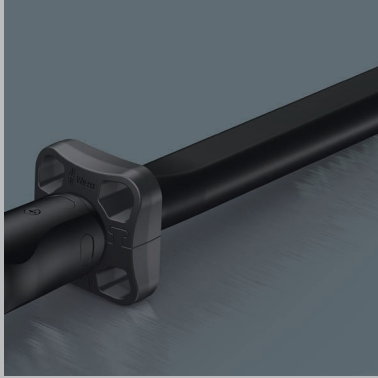

7762 Click-Torque 衬套M3

Click-Torque 衬套是Click-Torque扭矩扳手 B 1, B 2, C 1, C 2, C 3, C 4, X 2, X 3, X 4, X 5, XP 4, Click-Torque Push R/L C 2 和 Click-Torque Push R/L C 3的配件。

7762 Click-Torque 衬套M3



	EAN							
Code	4013288	mm	mm	mm				
05078709001	211767	55,0	55,0	21,5				1

7761 Click-Torque 衬套M4

Click-Torque 衬套为Click-Torque扭矩扳手C 5 和 X 6的配件。

7761 Click-Torque 衬套M5



	EAN							
Code	4013288	mm	mm	mm				
05078706001	211750	55,0	55,0	21,5				1

7763 Click-Torque 衬套M5

Click-Torque衬套是Click-Torque 扭矩扳手E 1 和 Click-Torque Push R/L E 1的配件。

7763 Click-Torque 衬套M5



	EAN							
Code	4013288	mm	mm	mm				
05078711001	211774	73,0	73,0	27,0				1

2090 冲击螺丝刀 90 Nm

- 不用借助电动工具即可松开和紧固螺丝
- 可将冲击力转化成旋转动力
- 双弧形设计特别有效。
- 5/16"内六角接头

2090 冲击螺丝刀 90 Nm



	EAN	⊙	⌀	⌀					
Code	4013288		mm						
05072014001	180926	5/16"	142,0	5 19/32"					1

2090/17 冲击螺丝刀组套

- 2090冲击螺丝刀, 90Nm, 带多种附件
- 不用借助电动工具即可松开和紧固螺丝
- 可将冲击力转化成旋转动力
- 双弧形设计特别有效
- 5/16"内六角接头

2090/17 冲击螺丝刀组套



Code	EAN		
05072017001	179777		1
		2090 90 Nm 1x 5/16"x142,0	
		851/2 Z PH 1x PH 2x32; 1x PH 3x32	
		851/2 PH 1x PH 4x32	
		800/2 1x 2,0x12,0x41	
		840/2 Z 1x 5x30; 1x 6x30; 1x 8x30; 1x 10x30	
		840/2 1x 7,0x30	
		867/2 Z TORX® 1x TX 30x35; 1x TX 40x35; 1x TX 45x35; 1x TX 50x35; 1x TX 55x35	
		870/2 1x 3/8"x5/16" ¹⁾ ; 1x 1/2"x5/16" ¹⁾	

¹⁾ 带摩擦球, 用于手动螺母扳手套筒

扭矩测试值



一字工具

驱动器: DIN ISO 2380, VSM 35601。
在测试量具中评估扭矩值
根据 DIN ISO 2380 扭矩
检测设备。



六边形工具

驱动器: DIN ISO 2936。
力矩测试量具中评估的值
根据 DIN ISO 2936
扭矩测试设备。



PH 和 PZ 工具

驱动器: DIN 5260, ISO 8764 和
SMS-SS 1687。
在测试量具中评估扭矩值
根据 DIN 5261, ISO 8764
扭矩测试设备。



带 TORQ-SET® 驱动器的工具

通过测试评估扭矩值
十字螺丝公司的量具, 许可方
的 TORQ-SET®, 关于扭矩测试
设备。

a x b mm	扭矩, 单位 Nm (分钟)	
	手用	电力使用
0,3 x 2,0	0,18	0,20
0,4 x 2,0	0,30	0,35
0,4 x 2,5	0,40	0,45
0,5 x 3,0	0,70	0,80
0,5 x 3,5	0,90	0,98
0,6 x 3,5	1,30	1,40
0,6 x 4,0	1,40	1,61
0,6 x 4,5	-	1,80
0,8 x 4,0	2,60	2,90
0,8 x 4,5	2,88	
0,8 x 5,0	3,20	3,58
0,8 x 5,5	3,50	3,90
1,0 x 5,5	5,50	6,20
1,0 x 6,5	6,50	7,28
1,0 x 7,0	7,0	7,80
1,2 x 6,5	9,40	10,50
1,2 x 7,0	10,0	11,28
1,2 x 8,0	11,5	12,90
1,4 x 9,0	17,6	19,70
1,5 x 13	29	32
1,6 x 8,0	20,5	22,9
1,6 x 9,0	23	25
1,6 x 10	25,6	28,7
2,0 x 12	48,0	53
2,0 x 13	52	58
2,5 x 14	87	98
2,5 x 16	100	112
3,0 x 18	162	181

SW (mm)	扭矩, 单位 Nm (分钟)
0,7	0,08
0,9	0,18
1,3	0,53
1,5	0,82
2,0	1,9
2,5	3,8
3	6,6
3,5	11
4	16
4,5	24
5	30
6	52
7	78
8	120
9	180
10	220
11	295
12	370
13	480
14	590
17	1000
19	1000
22	1000
24	1000
27	1000

扭矩, 单位 Nm (分钟)	手用		电力使用	
	0	1,0	1,0	
1	3,5	3,9		
2	8,2	10,3		
3	19,5	32,0		
4	38,0	88,7		

扭矩, 单位 Nm (分钟)	批头		螺丝刀	
	2	1,1	1,1	
3	1,7	1,7		
4	2,8	2,8		
5	4,0	4,0		
6	5,1	5,1		
8	8,5	8,5		
10	11,3	11,3		
1/4"	28	17		
5/16"	56	28		
3/8"	102	62		
7/16"	147			
1/2"	249			
9/16"	271			
5/8"	339			



带 TORQ-SET® 驱动器的工具
通过测试评估扭矩值
十字螺丝公司的量具, 许可方
的 TORQ-SET®, 关于扭矩测试
设备。

扭矩, 单位 Nm (分钟)	TORX®			TORX PLUS®		
	批头	防盗批头	螺丝刀	批头	防盗批头	螺丝刀
1	0,10	-	0,08	0,11		
2	0,14	-	0,12	0,16		
3	0,25	-	0,21	0,28		
4	0,37	-	0,31	0,44		
5	0,51	-	0,43	0,61		
6	0,91	-	0,75	1,11		0,92
7	1,7	1,4	1,4	2,10		1,68
8	2,6	2,2	2,2	3,21	2,5	2,79
9	3,4	2,9	2,8	4,19	3,3	3,49
10	4,5	3,8	3,7	5,42	4,3	4,47
15	7,7	6,5	6,4	9,62	7,3	8,06
20	12,7	10,8	10,5	16,15	11,9	13,41
25	19,0	16,1	15,9	23,50	17,4	19,58
27	26,9	22,9	22,5	34,62	25,1	28,95
30	37,4	31,8	31,1	47,18	33,5	39,34
40	65,1	55,3	54,1	82,08	59,4	68,40
45	104	88	86	137,38	97,3	114,44
50	159	135	132	194,54	152,4	162,14
55	257	218	218	352,10	291,5	299,25
60	445	379	379	566,11	483,0	481,24
70	701	596	600	910,40	713,3	773,91

重要装置:

使用最小值进行扭矩测试后, 螺丝刀
尖端不应出现任何变形或损伤。

刀头

TORX® 螺丝

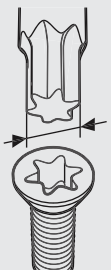
	
	A Ref. (毫米)
TX 1	0,84
TX 2	0,94
TX 3	1,12
TX 4	1,30
TX 5	1,37
TX 6	1,65
TX 7	1,97
TX 8	2,30
TX 9	2,48
TX 10	2,72
TX 15	3,26
TX 20	3,84
TX 25	4,40
TX 27	4,96
TX 30	5,49
TX 40	6,60
TX 45	7,77
TX 50	8,79
TX 55	11,17
TX 60	13,20
TX 70	15,49

TORX PLUS® 螺丝

	
	A Ref. (毫米)
1 IP	0,84
2 IP	0,95
3 IP	1,13
4 IP	1,29
5 IP	1,41
6 IP	1,69
7 IP	1,97
8 IP	2,29
9 IP	2,48
10 IP	2,72
15 IP	3,25
20 IP	3,84
25 IP	4,39
27 IP	4,95
30 IP	5,49
40 IP	6,60
45 IP	7,77
50 IP	8,79
55 IP	11,16
60 IP	13,20
70 IP	15,48

TORX PLUS® 螺丝

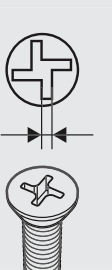
	
	A Ref. (毫米)
0	0,43
1	0,43
2	0,43
3	0,48
4	0,56
5	0,63
6	0,71
8	0,84
10	0,96
1/4"	1,27
5/16"	1,60
3/8"	1,90
7/16"	2,23
1/2"	2,54

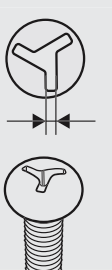

TRI-WING® 螺丝

	
	A Ref. (毫米)
0	0,45
1	0,57
2	0,75
3	0,95
4	1,08
5	1,23
6	1,54
7	1,87
8	2,17
9	2,48
10	2,78

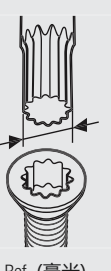
XZN 螺丝

	
	A Ref. (毫米)
M 4	3,83
M 5	4,80
M 6	6,00
M 8	7,20
M 10	9,60
M 12	11,41
M 14	13,22
M 16	15,63
M 18	16,85
M 20	19,25

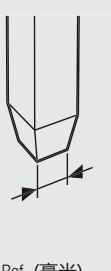
四方螺丝

		
	A Ref. (毫米)	A Ref. (毫米)
00	1,27	1,4
0	1,78	2
1	2,31	2,5
2	2,85	3,1
3	3,37	3,7
4	4,84	5,1

双控螺丝

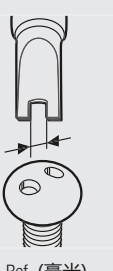
	
	A Ref. (毫米)
4	1,52
6	2,41
8	2,79
10	3,30

扭矩换算表

转换单位	SI 单位			公制		英制		
	cNm	dNm	Nm	cmkg	mkg	ft.lb	in.lb	in.oz
1 cNm =	1	0,1	0,01	0,1020	0,0010	0,0074	0,0885	1,4161
1 dNm =	10	1	0,1	1,0197	0,0102	0,0738	0,8851	14,1612
1 Nm =	100	10	1	10,1972	0,1020	0,7376	8,8508	141,6123
1 cmkg =	9,8067	0,9807	0,0981	1	0,0100	0,0723	0,8680	13,8874
1 mkg =	980,6650	98,0665	9,8067	100	1	7,2330	86,7964	1388,7422
1 ft.lb =	135,5818	13,5581	1,3558	13,8255	0,1383	1	12	192
1 in.lb =	11,2985	1,1298	0,1130	1,1521	0,0115	0,0833	1	16
1 in. oz =	0,7062	0,0706	0,0071	0,0720	0,0007	0,0052	0,0625	1

例1

1 Nm = 0,102 mkg
 17,4 Nm = 17,4 x 0,102 mkg
 17,4 Nm = 1,775 mkg

例2

1 mkg = 9,8067 Nm
 12,5 mkg = 12,5 x 9,8067 Nm
 12,5 mkg = 122,58 Nm

转换 Nm 至 mkg

1 Nm = 0,10197 mkg

Nm	0	1	2	3	4	5	6	7	8	9
0	0,00	0,10	0,20	0,31	0,41	0,51	0,61	0,71	0,82	0,92
10	1,02	1,12	1,22	1,33	1,43	1,53	1,63	1,73	1,84	1,94
20	2,04	2,14	2,24	2,35	2,45	2,55	2,65	2,75	2,86	2,96
30	3,06	3,16	3,26	3,37	3,47	3,57	3,67	3,77	3,87	3,98
40	4,08	4,18	4,28	4,38	4,49	4,59	4,69	4,79	4,89	5,00
50	5,10	5,20	5,30	5,40	5,51	5,61	5,71	5,81	5,91	6,02
60	6,12	6,22	6,32	6,42	6,53	6,63	6,73	6,83	6,93	7,04
70	7,14	7,24	7,34	7,44	7,55	7,65	7,75	7,85	7,95	8,06
80	8,16	8,26	8,36	8,46	8,57	8,67	8,77	8,87	8,97	9,08
90	9,18	9,28	9,38	9,48	9,59	9,69	9,79	9,89	9,99	10,10
100	10,20	10,30	10,40	10,50	10,60	10,71	10,81	10,91	11,01	11,11

转换 mkg 至 Nm

1 mkg = 9,80665 Nm

mkg	0	1	2	3	4	5	6	7	8	9
0	0,00	9,81	19,61	29,42	39,23	49,03	58,84	68,65	78,45	88,26
10	98,07	107,87	117,68	127,49	137,29	147,10	156,91	166,71	176,52	186,33
20	196,13	205,94	215,75	225,55	235,36	245,17	254,97	264,78	274,59	284,39
30	294,20	304,01	313,81	323,62	333,43	343,23	353,04	362,85	372,65	382,46
40	392,27	402,07	411,88	421,69	431,49	441,30	451,11	460,91	470,72	480,53
50	490,33	500,14	509,95	519,75	529,56	539,37	549,17	558,98	568,79	578,59
60	588,40	598,21	608,01	617,82	627,63	637,43	647,24	657,05	666,85	676,66
70	686,47	696,27	706,08	715,89	725,69	735,50	745,31	755,11	764,92	774,73
80	784,53	794,34	804,15	813,95	823,76	833,57	843,37	853,18	862,99	872,79
90	882,60	892,41	902,21	912,02	921,83	931,63	941,44	951,25	961,05	970,86
100	980,67	990,47	1000,28	1010,08	1019,89	1029,70	1039,50	1049,31	1059,12	1068,92

转换 Nm 至 ft.lb

1 Nm = 0,73756 ft.lb

Nm	0	1	2	3	4	5	6	7	8	9
0	0,00	0,74	1,48	2,21	2,95	3,69	4,43	5,16	5,90	6,64
10	7,38	8,11	8,85	9,59	10,33	11,06	11,80	12,54	13,28	14,01
20	14,75	15,49	16,23	16,96	17,70	18,44	19,18	19,91	20,65	21,39
30	22,13	22,86	23,60	24,34	25,08	25,81	26,55	27,29	28,03	28,76
40	29,50	30,24	30,98	31,72	32,45	33,19	33,93	34,67	35,40	36,14
50	36,88	37,62	38,35	39,09	39,83	40,57	41,30	42,04	42,78	43,52
60	44,25	44,99	45,73	46,47	47,20	47,94	48,68	49,42	50,15	50,89
70	51,63	52,37	53,10	53,84	54,58	55,32	56,05	56,79	57,53	58,27
80	59,00	59,74	60,48	61,22	61,96	62,69	63,43	64,17	64,91	65,64
90	66,38	67,12	67,86	68,59	69,33	70,07	70,81	71,54	72,28	73,02
100	73,76	74,49	75,23	75,97	76,71	77,44	78,18	78,92	79,66	80,39

转换 ft.lb 至 Nm

1 ft.lb = 1,35581 Nm

ft.lb	0	1	2	3	4	5	6	7	8	9
0	0,00	1,36	2,71	4,07	5,42	6,78	8,13	9,49	10,85	12,20
10	13,56	14,91	16,27	17,63	18,98	20,34	21,69	23,05	24,40	25,76
20	27,12	28,47	29,83	31,18	32,54	33,90	35,25	36,61	37,96	39,32
30	40,67	42,03	43,39	44,74	46,10	47,45	48,81	50,16	51,52	52,88
40	54,23	55,59	56,94	58,30	59,66	61,01	62,37	63,72	65,08	66,43
50	67,79	69,15	70,50	71,86	73,21	74,57	75,93	77,28	78,64	79,99
60	81,35	82,70	84,06	85,42	86,77	88,13	89,48	90,84	92,20	93,55
70	94,91	96,26	97,62	98,97	100,33	101,69	103,04	104,40	105,75	107,11
80	108,46	109,82	111,18	112,53	113,89	115,24	116,60	117,96	119,31	120,67
90	122,02	123,38	124,73	126,09	127,45	128,80	130,16	131,51	132,87	134,23
100	135,58	136,94	138,29	139,65	141,00	142,36	143,72	145,07	146,43	147,78

转换 Nm 至 in.lb

1 Nm = 8,85077 in.lb

Nm	0	1	2	3	4	5	6	7	8	9
0	0,00	8,85	17,70	26,55	35,40	44,25	53,10	61,96	70,81	79,66
10	88,51	97,36	106,21	115,06	123,91	132,76	141,61	150,46	159,31	168,16
20	177,02	185,87	194,72	203,57	212,42	221,27	230,12	238,97	247,82	256,67
30	265,52	274,37	283,22	292,08	300,93	309,78	318,63	327,48	336,33	345,18
40	354,03	362,88	371,73	380,58	389,43	398,28	407,14	415,99	424,84	433,69
50	442,54	451,39	460,24	469,09	477,94	486,79	495,64	504,49	513,34	522,20
60	531,05	539,90	548,75	557,60	566,45	575,30	584,15	593,00	601,85	610,70
70	619,55	628,40	637,26	646,11	654,96	663,81	672,66	681,51	690,36	699,21
80	708,06	716,91	725,76	734,61	743,46	752,32	761,17	770,02	778,87	787,72
90	796,57	805,42	814,27	823,12	831,97	840,82	849,67	858,52	867,38	876,23
100	885,08	893,93	902,78	911,63	920,48	929,33	938,18	947,03	955,88	964,73

转换 in.lb 至 Nm

1 in.lb = 0,11298 Nm

in.lb	0	1	2	3	4	5	6	7	8	9
0	0,00	0,11	0,23	0,34	0,45	0,56	0,68	0,79	0,90	1,02
10	1,13	1,24	1,36	1,47	1,58	1,69	1,81	1,92	2,03	2,15
20	2,26	2,37	2,49	2,60	2,71	2,82	2,94	3,05	3,16	3,28
30	3,39	3,50	3,62	3,73	3,84	3,95	4,07	4,18	4,29	4,41
40	4,52	4,63	4,75	4,86	4,97	5,08	5,20	5,31	5,42	5,54
50	5,65	5,76	5,87	5,99	6,10	6,21	6,33	6,44	6,55	6,67
60	6,78	6,89	7,00	7,12	7,23	7,34	7,46	7,57	7,68	7,80
70	7,91	8,02	8,13	8,25	8,36	8,47	8,59	8,70	8,81	8,93
80	9,04	9,15	9,26	9,38	9,49	9,60	9,72	9,83	9,94	10,06
90	10,17	10,28	10,39	10,51	10,62	10,73	10,85	10,96	11,07	11,19
100	11,30	11,41	11,52	11,64	11,75	11,86	11,98	12,09	12,20	12,31

转换 of inches 至 millimeters

Inches 英寸		0	1	2	3	4	5	6	7	8	9
			25.400	50.800	76.200	101.600	127.000	152.400	177.800	203.200	228.600
$\frac{1}{64}$	0.015625	0.397	25.797	51.197	76.597	101.997	127.397	152.797	178.197	203.597	228.997
$\frac{1}{32}$	0.03125	0.794	26.194	51.594	76.994	102.394	127.794	153.194	178.594	203.994	229.394
$\frac{3}{64}$	0.046875	1.191	26.591	51.991	77.391	102.791	128.191	153.591	178.991	204.391	229.791
$\frac{1}{16}$	0.0625	1.588	26.988	52.388	77.788	103.188	128.588	153.988	179.388	204.788	230.188
$\frac{5}{64}$	0.078125	1.984	27.384	52.784	78.184	103.584	128.984	154.384	179.784	205.184	230.584
$\frac{3}{32}$	0.09375	2.381	27.781	53.181	78.581	103.981	129.381	154.781	180.181	205.581	230.981
$\frac{7}{64}$	0.109375	2.778	28.178	53.578	78.978	104.378	129.778	155.178	180.578	205.978	231.378
$\frac{1}{8}$	0.125	3.175	28.575	53.975	79.375	104.775	130.175	155.575	180.975	206.375	231.775
$\frac{9}{64}$	0.140625	3.572	28.972	54.372	79.772	105.172	130.572	155.972	181.372	206.772	232.172
$\frac{5}{32}$	0.15625	3.969	29.369	54.769	80.169	105.569	130.969	156.369	181.769	207.169	232.569
$\frac{11}{64}$	0.171875	4.366	29.766	55.166	80.566	105.966	131.366	156.766	182.166	207.566	232.966
$\frac{3}{16}$	0.1875	4.762	30.162	55.562	80.962	106.362	131.762	157.162	182.562	207.962	233.362
$\frac{13}{64}$	0.203125	5.159	30.559	55.959	81.359	106.759	132.159	157.559	182.959	208.359	233.759
$\frac{7}{32}$	0.21875	5.556	30.956	56.356	81.756	107.156	132.556	157.956	183.356	208.756	234.156
$\frac{15}{64}$	0.234375	5.953	31.353	56.753	82.153	107.553	132.953	158.353	183.753	209.153	234.553
$\frac{1}{4}$	0.25	6.350	31.750	57.150	82.550	107.950	133.350	158.750	184.150	209.550	234.950
$\frac{17}{64}$	0.265625	6.747	32.147	57.547	82.947	108.347	133.747	159.147	184.547	209.947	235.347
$\frac{9}{32}$	0.28125	7.144	32.544	57.944	83.344	108.744	134.144	159.544	184.944	210.344	235.744
$\frac{19}{64}$	0.296875	7.541	32.941	58.341	83.741	109.141	134.541	159.941	185.341	210.741	236.141
$\frac{5}{16}$	0.3125	7.938	33.338	58.738	84.138	109.538	134.938	160.338	185.738	211.138	236.538
$\frac{21}{64}$	0.328125	8.334	33.734	59.134	84.534	109.934	135.334	160.734	186.134	211.534	236.934
$\frac{11}{32}$	0.34375	8.731	34.131	59.531	84.931	110.331	135.731	161.131	186.531	211.931	237.331
$\frac{23}{64}$	0.359375	9.128	34.528	59.928	85.328	110.728	136.128	161.528	186.928	212.328	237.728
$\frac{3}{8}$	0.375	9.525	34.925	60.325	85.725	111.125	136.525	161.925	187.325	212.725	238.125
$\frac{25}{64}$	0.390625	9.922	35.322	60.722	86.122	111.522	136.922	162.322	187.722	213.122	238.522
$\frac{13}{32}$	0.40625	10.319	35.719	61.119	86.519	111.919	137.319	162.719	188.119	213.519	238.919
$\frac{27}{64}$	0.421875	10.716	36.116	61.516	86.916	112.316	137.716	163.116	188.516	213.916	239.316
$\frac{7}{16}$	0.4375	11.112	36.512	61.912	87.312	112.712	138.112	163.512	188.912	214.312	239.712
$\frac{29}{64}$	0.453125	11.509	36.909	62.309	87.709	113.109	138.509	163.909	189.309	214.709	240.109
$\frac{15}{32}$	0.46875	11.906	37.306	62.706	88.106	113.506	138.906	164.306	189.706	215.106	240.506
$\frac{31}{64}$	0.484375	12.303	37.703	63.103	88.503	113.903	139.303	164.703	190.103	215.503	240.903
$\frac{1}{2}$	0.5	12.700	38.100	63.500	88.900	114.300	139.700	165.100	190.500	215.900	241.300
$\frac{33}{64}$	0.515625	13.097	38.497	63.897	89.297	114.697	140.097	165.497	190.897	216.297	241.697
$\frac{17}{32}$	0.53125	13.494	38.894	64.294	89.694	115.094	140.494	165.894	191.294	216.694	242.094
$\frac{35}{64}$	0.546875	13.891	39.291	64.691	90.091	115.491	140.891	166.291	191.691	217.091	242.491
$\frac{9}{16}$	0.5625	14.288	39.688	65.088	90.488	115.888	141.288	166.688	192.088	217.488	242.888
$\frac{37}{64}$	0.578125	14.684	40.084	65.484	90.884	116.284	141.684	167.084	192.484	217.884	243.284
$\frac{19}{32}$	0.59375	15.081	40.481	65.881	91.281	116.681	142.081	167.481	192.881	218.281	243.681
$\frac{39}{64}$	0.609375	15.478	40.878	66.278	91.678	117.078	142.478	167.878	193.278	218.678	244.078
$\frac{5}{8}$	0.625	15.875	41.275	66.675	92.075	117.475	142.875	168.275	193.675	219.075	244.475
$\frac{41}{64}$	0.640625	16.272	41.672	67.072	92.472	117.872	143.272	168.672	194.072	219.472	244.872
$\frac{21}{32}$	0.65625	16.669	42.069	67.469	92.869	118.269	143.669	169.069	194.469	219.869	245.269
$\frac{43}{64}$	0.671875	17.066	42.466	67.866	93.266	118.666	144.066	169.466	194.866	220.266	245.666
$\frac{11}{16}$	0.6875	17.462	42.862	68.262	93.662	119.062	144.462	169.862	195.262	220.662	246.062
$\frac{45}{64}$	0.703125	17.859	43.259	68.659	94.059	119.459	144.859	170.259	195.659	221.059	246.459
$\frac{23}{32}$	0.71875	18.256	43.656	69.056	94.456	119.856	145.256	170.656	196.056	221.456	246.856
$\frac{47}{64}$	0.734375	18.653	44.053	69.453	94.853	120.253	145.653	171.053	196.453	221.853	247.253
$\frac{3}{4}$	0.75	19.050	44.450	69.850	95.250	120.650	146.050	171.450	196.850	222.250	247.650
$\frac{49}{64}$	0.765625	19.447	44.847	70.247	95.647	121.047	146.447	171.847	197.247	222.647	248.047
$\frac{25}{32}$	0.78125	19.844	45.244	70.644	96.044	121.444	146.844	172.244	197.644	223.044	248.444
$\frac{51}{64}$	0.796875	20.241	45.641	71.041	96.441	121.841	147.241	172.641	198.041	223.441	248.841
$\frac{13}{16}$	0.8125	20.638	46.038	71.438	96.838	122.238	147.638	173.038	198.438	223.838	249.238
$\frac{53}{64}$	0.828125	21.034	46.434	71.834	97.234	122.634	148.034	173.434	198.834	224.234	249.634
$\frac{27}{32}$	0.84375	21.431	46.831	72.231	97.631	123.031	148.431	173.831	199.231	224.631	250.031
$\frac{55}{64}$	0.859375	21.828	47.228	72.628	98.028	123.428	148.828	174.228	199.628	225.028	250.428
$\frac{7}{8}$	0.875	22.225	47.625	73.025	98.425	123.825	149.225	174.625	200.025	225.425	250.825
$\frac{57}{64}$	0.890625	22.622	48.022	73.422	98.822	124.222	149.622	175.022	200.422	225.822	251.222
$\frac{29}{32}$	0.90625	23.019	48.419	73.819	99.219	124.619	150.019	175.419	200.819	226.219	251.619
$\frac{59}{64}$	0.921875	23.416	48.816	74.216	99.616	125.016	150.416	175.816	201.216	226.616	252.016
$\frac{15}{16}$	0.9375	23.812	49.212	74.612	100.012	125.412	150.812	176.212	201.612	227.012	252.412
$\frac{61}{64}$	0.953125	24.209	49.609	75.009	100.409	125.809	151.209	176.609	202.009	227.409	252.809
$\frac{31}{32}$	0.96875	24.606	50.006	75.406	100.806	126.206	151.606	177.006	202.406	227.806	253.206
$\frac{63}{64}$	0.984375	25.003	50.403	75.803	101.203	126.603	152.003	177.403	202.803	228.203	253.603

数值单位 毫米 mm

货号索引

货号	页数	货号	页数	货号	页数	货号	页数				
05 002900	001	254	05 003080	001	130	05 003386	001	108	05 003564	001	122
05 002901	001	251	05 003081	001	130	05 003387	001	108	05 003565	001	122
05 002910	001	255	05 003082	001	130	05 003388	001	108	05 003566	001	122
05 002913	001	255	05 003083	001	130	05 003389	001	108	05 003567	001	122
05 002920	001	255	05 003084	001	130	05 003390	001	106	05 003568	001	122
05 002923	001	255	05 003085	001	130	05 003391	001	106	05 003569	001	122
05 002926	001	255	05 003086	001	130	05 003392	001	106	05 003570	001	122
05 002930	001	255	05 003087	001	130	05 003393	001	106	05 003571	001	122
05 002933	001	255	05 003088	001	130	05 003460	001	84	05 003572	001	122
05 002936	001	255	05 003089	001	130	05 003461	001	84	05 003573	001	122
05 002938	001	255	05 003090	001	130	05 003462	001	84	05 003574	001	122
05 002940	001	255	05 003091	001	130	05 003463	001	84	05 003575	001	122
05 002943	001	255	05 003092	001	130	05 003499	001	102	05 003576	001	122
05 002946	001	255	05 003093	001	130	05 003500	001	98	05 003577	001	122
05 002948	001	255	05 003094	001	130	05 003501	001	102	05 003578	001	122
05 002950	001	255	05 003180	001	131	05 003502	001	102	05 003579	001	122
05 002960	001	255	05 003181	001	132	05 003503	001	102	05 003580	001	122
05 002966	001	255	05 003185	001	129	05 003504	001	102	05 003581	001	134
05 002968	001	255	05 003210	001	254	05 003505	001	102	05 003582	001	134
05 002970	001	255	05 003320	001	109	05 003506	001	102	05 003583	001	134
05 002973	001	255	05 003321	001	109	05 003507	001	102	05 003584	001	134
05 002976	001	255	05 003322	001	109	05 003508	001	102	05 003585	001	134
05 002980	001	255	05 003330	001	108	05 003509	001	102	05 003590	001	134
05 002990	001	253	05 003331	001	108	05 003510	001	102	05 003591	001	133
05 003010	001	102	05 003332	001	108	05 003511	001	102	05 003592	001	133
05 003030	001	130	05 003333	001	108	05 003512	001	102	05 003594	001	114
05 003031	001	130	05 003334	001	108	05 003513	001	102	05 003596	001	114
05 003032	001	130	05 003335	001	108	05 003514	001	102	05 003600	001	138
05 003033	001	130	05 003336	001	108	05 003515	001	102	05 003601	001	145
05 003034	001	130	05 003337	001	108	05 003516	001	102	05 003602	001	145
05 003035	001	130	05 003338	001	108	05 003517	001	102	05 003603	001	145
05 003036	001	130	05 003339	001	108	05 003518	001	102	05 003604	001	145
05 003037	001	130	05 003340	001	108	05 003519	001	102	05 003605	001	145
05 003038	001	130	05 003341	001	108	05 003520	001	102	05 003606	001	145
05 003039	001	130	05 003342	001	108	05 003521	001	102	05 003607	001	145
05 003040	001	130	05 003345	001	109	05 003522	001	102	05 003608	001	145
05 003041	001	130	05 003350	001	109	05 003523	001	102	05 003609	001	145
05 003042	001	130	05 003351	001	109	05 003524	001	110	05 003610	001	145
05 003043	001	130	05 003352	001	109	05 003525	001	110	05 003611	001	145
05 003044	001	130	05 003353	001	109	05 003526	001	110	05 003612	001	145
05 003050	001	130	05 003354	001	109	05 003527	001	111	05 003613	001	145
05 003051	001	130	05 003355	001	109	05 003528	001	110	05 003614	001	145
05 003052	001	130	05 003360	001	106	05 003529	001	111	05 003615	001	145
05 003054	001	130	05 003361	001	106	05 003530	001	110	05 003616	001	145
05 003056	001	130	05 003362	001	106	05 003531	001	109	05 003617	001	145
05 003059	001	128	05 003363	001	106	05 003533	001	96	05 003618	001	145
05 003060	001	128	05 003364	001	106	05 003535	001	97	05 003619	001	145
05 003061	001	128	05 003365	001	106	05 003536	001	112	05 003620	001	145
05 003062	001	128	05 003366	001	106	05 003550	001	115	05 003621	001	145
05 003063	001	128	05 003367	001	106	05 003551	001	122	05 003622	001	145
05 003064	001	128	05 003368	001	106	05 003552	001	122	05 003623	001	145
05 003065	001	128	05 003369	001	106	05 003553	001	122	05 003624	001	145
05 003066	001	128	05 003370	001	106	05 003554	001	122	05 003625	001	145
05 003067	001	128	05 003371	001	106	05 003555	001	122	05 003626	001	145
05 003068	001	128	05 003372	001	106	05 003556	001	122	05 003627	001	145
05 003069	001	128	05 003375	001	107	05 003557	001	122	05 003628	001	145
05 003070	001	128	05 003380	001	108	05 003558	001	122	05 003629	001	145
05 003071	001	128	05 003381	001	108	05 003559	001	122	05 003630	001	145
05 003072	001	128	05 003382	001	108	05 003560	001	122	05 003631	001	145
05 003073	001	128	05 003383	001	108	05 003561	001	122	05 003632	001	145
05 003074	001	128	05 003384	001	108	05 003562	001	122	05 003633	001	145
05 003075	001	128	05 003385	001	108	05 003563	001	122	05 003634	001	145

货号索引

货号	页数	货号	页数	货号	页数	货号	页数
05 003635 001	145	05 003753 001	123	05 003995 001	146	05 004351 001	280
05 003636 001	155	05 003755 001	94	05 003996 001	153	05 004352 001	277
05 003637 001	155	05 003756 001	101	05 003997 001	150	05 004353 001	277
05 003638 001	154	05 003760 001	181	05 004003 001	100	05 004354 001	277
05 003639 001	155	05 003765 001	181	05 004004 001	101	05 004355 001	278
05 003640 001	155	05 003780 001	139	05 004016 001	95	05 004356 001	278
05 003641 001	155	05 003781 001	140	05 004017 001	99	05 004357 001	277
05 003642 001	154	05 003785 001	121	05 004018 001	100	05 004500 001	105
05 003643 001	154	05 003793 001	173	05 004019 001	95	05 004501 001	105
05 003645 001	137	05 003820 001	152	05 004020 001	99	05 004502 001	105
05 003647 001	138	05 003821 001	152	05 004021 001	101	05 004503 001	105
05 003660 001	172	05 003822 001	152	05 004033 001	119	05 004504 001	105
05 003665 001	173	05 003823 001	152	05 004034 001	121	05 004505 001	105
05 003666 001	173	05 003824 001	152	05 004046 001	113	05 004506 001	105
05 003667 001	173	05 003825 001	152	05 004047 001	118	05 004507 001	105
05 003668 001	173	05 003826 001	152	05 004048 001	120	05 004508 001	105
05 003669 001	173	05 003827 001	152	05 004049 001	113	05 004509 001	105
05 003670 001	173	05 003828 001	152	05 004050 001	119	05 004510 001	105
05 003675 001	173	05 003829 001	152	05 004051 001	121	05 004511 001	105
05 003684 001	173	05 003830 001	150	05 004063 001	141	05 004512 001	105
05 003685 001	173	05 003831 001	150	05 004064 001	142	05 004525 001	105
05 003690 001	173	05 003832 001	150	05 004076 001	136	05 004530 001	126
05 003692 001	160	05 003833 001	150	05 004077 001	140	05 004531 001	126
05 003695 001	161	05 003834 001	150	05 004078 001	141	05 004532 001	126
05 003696 001	161	05 003835 001	150	05 004079 001	137	05 004533 001	126
05 003697 001	161	05 003836 001	150	05 004080 001	141	05 004534 001	126
05 003717 001	102	05 003837 001	150	05 004081 001	142	05 004535 001	126
05 003718 001	102	05 003838 001	150	05 004090 001	139	05 004536 001	126
05 003719 001	102	05 003840 001	152	05 004095 001	139	05 004537 001	126
05 003720 001	102	05 003841 001	152	05 004170 001	168	05 004538 001	126
05 003721 001	102	05 003842 001	152	05 004171 001	225	05 004539 001	126
05 003722 001	102	05 003843 001	152	05 004172 001	169	05 004540 001	126
05 003723 001	102	05 003844 001	152	05 004173 001	200	05 004541 001	126
05 003724 001	102	05 003845 001	152	05 004174 001	46	05 004542 001	126
05 003725 001	102	05 003850 001	150	05 004175 001	115	05 004543 001	126
05 003726 001	102	05 003851 001	150	05 004176 001	133	05 004544 001	126
05 003727 001	102	05 003852 001	150	05 004177 001	171	05 004545 001	127
05 003728 001	102	05 003853 001	150	05 004178 001	184	05 004550 001	148
05 003729 001	102	05 003854 001	150	05 004179 001	239	05 004551 001	148
05 003730 001	145	05 003855 001	150	05 004180 001	400	05 004552 001	148
05 003731 001	145	05 003856 001	150	05 004181 001	184	05 004553 001	148
05 003732 001	145	05 003857 001	150	05 004182 001	31	05 004554 001	148
05 003733 001	145	05 003858 001	150	05 004183 001	170	05 004555 001	148
05 003734 001	145	05 003880 001	103	05 004184 001	31	05 004556 001	148
05 003735 001	145	05 003881 001	108	05 004185 001	239	05 004557 001	148
05 003736 001	145	05 003882 001	107	05 004190 001	28	05 004558 001	148
05 003737 001	145	05 003883 001	103	05 004201 001	153	05 004559 001	148
05 003738 001	145	05 003884 001	104	05 004202 001	151	05 004560 001	148
05 003739 001	145	05 003890 001	111	05 004203 001	147	05 004561 001	148
05 003740 001	123	05 003891 001	111	05 004210 001	153	05 004562 001	148
05 003741 001	123	05 003892 001	161	05 004211 001	151	05 004563 001	148
05 003742 001	123	05 003893 001	162	05 004212 001	152	05 004565 001	149
05 003743 001	123	05 003970 001	124	05 004280 001	156	05 004570 001	142
05 003744 001	123	05 003971 001	131	05 004281 001	157	05 004571 001	142
05 003745 001	123	05 003972 001	129	05 004282 001	156	05 004572 001	142
05 003746 001	123	05 003973 001	125	05 004283 001	158	05 004573 001	142
05 003747 001	123	05 003974 001	132	05 004284 001	159	05 004574 001	142
05 003748 001	123	05 003980 001	135	05 004285 001	159	05 004575 001	142
05 003749 001	123	05 003981 001	135	05 004310 001	63	05 004576 001	142
05 003750 001	123	05 003982 001	89	05 004313 001	22	05 004577 001	142
05 003751 001	123	05 003990 001	78	05 004350 001	276	05 004578 001	142
05 003752 001	123	05 003991 001	66	05 004351 001	276	05 004580 001	143

货号	页数	货号	页数	货号	页数	货号	页数				
05 004590	001	147	05 005310	001	62	05 006145	001	63	05 006516	001	81
05 004591	001	147	05 005315	001	62	05 006147	001	63	05 006517	001	81
05 004592	001	147	05 005320	001	62	05 006148	001	63	05 006518	001	83
05 004595	001	148	05 005325	001	62	05 006150	001	59	05 006519	001	83
05 004780	001	61	05 005330	001	62	05 006152	001	59	05 006520	001	83
05 004781	001	61	05 005335	001	62	05 006153	001	59	05 006521	001	83
05 004782	001	61	05 005340	001	62	05 006154	001	59	05 006522	001	83
05 004783	001	61	05 005400	001	104	05 006156	001	59	05 006523	001	80
05 004784	001	61	05 005410	001	106	05 006158	001	59	05 006524	001	80
05 004830	001	144	05 005420	001	104	05 006159	001	59	05 006525	001	80
05 004831	001	144	05 005430	001	125	05 006160	001	59	05 006526	001	81
05 004832	001	144	05 005440	001	127	05 006162	001	59	05 006527	001	81
05 004833	001	144	05 005450	001	126	05 006163	001	59	05 006528	001	81
05 004834	001	144	05 005451	001	123	05 006164	001	59	05 006529	001	81
05 004835	001	144	05 005452	001	124	05 006165	001	59	05 006530	001	82
05 004836	001	144	05 005460	001	151	05 006166	001	59	05 006531	001	82
05 004837	001	144	05 005470	001	149	05 006168	001	59	05 006532	001	82
05 004838	001	144	05 005480	001	146	05 006169	001	61	05 006533	001	82
05 004839	001	144	05 005490	001	143	05 006170	001	61	05 006534	001	82
05 004840	001	144	05 005500	001	122	05 006172	001	61	05 006535	001	82
05 004841	001	144	05 005501	001	122	05 006174	001	61	05 006536	001	82
05 004900	001	88	05 005502	001	122	05 006176	001	61	05 006537	001	82
05 004901	001	88	05 005503	001	122	05 006177	001	61	05 006538	001	82
05 004902	001	88	05 005504	001	122	05 006178	001	61	05 006539	001	82
05 004903	001	88	05 005505	001	122	05 006179	001	61	05 006540	001	83
05 004920	001	88	05 005506	001	122	05 006181	001	61	05 006541	001	83
05 004921	001	88	05 005507	001	122	05 006182	001	61	05 006542	001	83
05 004922	001	88	05 005508	001	122	05 006183	001	61	05 006543	001	83
05 004923	001	88	05 005509	001	122	05 006184	001	61	05 006544	001	83
05 004924	001	88	05 005510	001	122	05 006190	001	60	05 006545	001	83
05 004925	001	88	05 005511	001	122	05 006191	001	60	05 006546	001	83
05 004930	001	87	05 005512	001	122	05 006380	001	60	05 006550	001	79
05 004940	001	88	05 005513	001	122	05 006381	001	60	05 006551	001	79
05 004941	001	88	05 005514	001	122	05 006440	001	58	05 006552	001	79
05 004942	001	88	05 005515	001	122	05 006441	001	58	05 006553	001	79
05 004950	001	88	05 005516	001	122	05 006442	001	58	05 006554	001	79
05 004951	001	88	05 005517	001	122	05 006450	001	59	05 006555	001	79
05 004952	001	88	05 005518	001	122	05 006451	001	59	05 006556	001	80
05 004953	001	88	05 005519	001	122	05 006455	001	60	05 006557	001	80
05 004954	001	88	05 005520	001	122	05 006456	001	60	05 006558	001	80
05 004955	001	88	05 005521	001	122	05 006460	001	60	05 006559	001	80
05 004956	001	88	05 005522	001	122	05 006461	001	60	05 006560	001	80
05 004957	001	88	05 005523	001	122	05 006465	001	61	05 006561	001	83
05 004958	001	88	05 005524	001	122	05 006466	001	61	05 006562	001	83
05 004959	001	88	05 005525	001	122	05 006470	001	65	05 006563	001	83
05 004960	001	88	05 005526	001	122	05 006480	001	64	05 006564	001	83
05 004961	001	88	05 005530	001	116	05 006500	001	79	05 006565	001	83
05 004962	001	88	05 005531	001	117	05 006501	001	79	05 006566	001	81
05 004963	001	88	05 005540	001	117	05 006502	001	79	05 006567	001	81
05 004964	001	89	05 005655	001	62	05 006503	001	79	05 006568	001	82
05 004965	001	89	05 006100	001	58	05 006504	001	79	05 006569	001	82
05 004966	001	87	05 006105	001	58	05 006505	001	79	05 006570	001	82
05 004970	001	86	05 006110	001	58	05 006506	001	80	05 006571	001	82
05 004980	001	91	05 006115	001	58	05 006507	001	80	05 006572	001	82
05 004981	001	91	05 006116	001	58	05 006508	001	80	05 006573	001	82
05 005080	001	394	05 006120	001	58	05 006509	001	80	05 006574	001	82
05 005081	001	394	05 006121	001	58	05 006510	001	80	05 006575	001	67
05 005090	001	394	05 006125	001	58	05 006511	001	80	05 006576	001	67
05 005091	001	394	05 006126	001	58	05 006512	001	80	05 006577	001	67
05 005120	001	86	05 006130	001	58	05 006513	001	80	05 006578	001	67
05 005300	001	62	05 006135	001	58	05 006514	001	81	05 006579	001	67
05 005305	001	62	05 006140	001	58	05 006515	001	81	05 006580	001	67

货号索引

货号	页数	货号	页数	货号	页数	货号	页数
05 006581	001 67	05 008712	001 13	05 017015	001 9	05 020070	001 179
05 006582	001 68	05 008715	001 13	05 017020	001 9	05 020071	001 179
05 006583	001 68	05 008720	001 13	05 017040	001 9	05 020072	001 179
05 006584	001 68	05 008723	001 13	05 017041	001 9	05 020073	001 179
05 006585	001 68	05 008725	001 13	05 017050	001 9	05 020074	001 179
05 006586	001 69	05 008730	001 13	05 017052	001 9	05 020075	001 179
05 006587	001 69	05 008735	001 13	05 017054	001 9	05 020076	001 179
05 006588	001 69	05 008740	001 13	05 017056	001 9	05 020077	001 179
05 006589	001 69	05 008750	001 13	05 018100	001 232	05 020078	001 179
05 006590	001 68	05 008751	001 13	05 018110	001 231	05 020079	001 179
05 006591	001 68	05 008752	001 13	05 018111	001 231	05 020080	001 179
05 006592	001 68	05 008753	001 13	05 018140	001 233	05 020081	001 179
05 006600	001 77	05 008840	001 19	05 018141	001 233	05 020082	001 179
05 006601	001 77	05 008841	001 19	05 018142	001 233	05 020090	001 180
05 006603	001 76	05 008842	001 19	05 018150	001 233	05 020091	001 180
05 006604	001 77	05 008843	001 19	05 018151	001 233	05 020092	001 180
05 006605	001 71	05 008844	001 19	05 018152	001 233	05 020093	001 180
05 006607	001 76	05 008850	001 20	05 018153	001 233	05 020099	001 187
05 006608	001 75	05 008851	001 20	05 018154	001 233	05 020100	001 187
05 006609	001 71	05 008852	001 20	05 018155	001 233	05 020101	001 188
05 006611	001 75	05 008853	001 20	05 018156	001 233	05 020102	001 188
05 006612	001 74	05 008854	001 20	05 018157	001 233	05 020103	001 187
05 006613	001 73	05 008855	001 20	05 018160	001 232	05 020104	001 188
05 006614	001 74	05 008856	001 20	05 018161	001 232	05 020110	001 188
05 006616	001 73	05 008857	001 20	05 018162	001 232	05 020129	001 58
05 006617	001 72	05 008858	001 20	05 018163	001 232	05 020131	001 59
05 006618	001 70	05 008859	001 20	05 018164	001 232	05 020132	001 61
05 006619	001 70	05 008860	001 20	05 018165	001 232	05 020133	001 59
05 006630	001 66	05 008861	001 20	05 018166	001 232	05 020134	001 61
05 006631	001 65	05 008862	001 20	05 018167	001 232	05 020150	001 90
05 006640	001 78	05 008863	001 20	05 018168	001 232	05 020151	001 91
05 006641	001 79	05 008864	001 20	05 018169	001 232	05 020152	001 91
05 007610	001 12	05 008870	001 27	05 018170	001 232	05 020153	001 91
05 007620	001 12	05 008871	001 27	05 018171	001 233	05 020170	001 90
05 007621	001 12	05 008872	001 27	05 018172	001 233	05 020171	001 414
05 007635	001 12	05 008873	001 237	05 018173	001 233	05 020172	001 413
05 007640	001 12	05 008874	001 237	05 018260	001 8	05 020173	001 413
05 007670	001 12	05 008875	001 237	05 018262	001 8	05 020190	001 181
05 007671	001 12	05 008876	001 27	05 018264	001 8	05 020198	001 181
05 007672	001 12	05 008877	001 237	05 018266	001 8	05 020199	001 181
05 007673	001 12	05 008878	001 237	05 018268	001 8	05 020200	001 181
05 007674	001 12	05 008880	001 250	05 018270	001 8	05 020201	001 181
05 007675	001 12	05 008881	001 55	05 018272	001 8	05 020202	001 181
05 007676	001 12	05 008882	001 55	05 018274	001 8	05 020203	001 181
05 007677	001 12	05 008883	001 236	05 018282	001 10	05 020204	001 181
05 007680	001 22	05 008884	001 236	05 018283	001 10	05 020205	001 181
05 007681	001 23	05 008886	001 236	05 018287	001 10	05 020206	001 181
05 008006	001 11	05 009305	001 14	05 018300	001 8	05 020207	001 181
05 008007	001 11	05 009310	001 14	05 018301	001 8	05 020208	001 181
05 008008	001 11	05 009312	001 14	05 018302	001 8	05 020209	001 181
05 008009	001 11	05 009313	001 14	05 020012	001 178	05 020210	001 181
05 008015	001 11	05 009315	001 14	05 020013	001 178	05 020211	001 181
05 008027	001 11	05 009317	001 14	05 020014	001 177	05 020212	001 181
05 008055	001 11	05 009319	001 14	05 020015	001 177	05 020213	001 181
05 008060	001 11	05 009320	001 14	05 020016	001 177	05 020214	001 181
05 008061	001 11	05 009325	001 14	05 020022	001 178	05 020215	001 181
05 008100	001 26	05 009340	001 13	05 020064	001 179	05 020216	001 181
05 008101	001 18	05 009341	001 13	05 020065	001 179	05 020217	001 181
05 008102	001 18	05 009342	001 13	05 020066	001 179	05 020218	001 181
05 008705	001 13	05 009343	001 13	05 020067	001 179	05 020219	001 181
05 008706	001 13	05 017005	001 9	05 020068	001 179	05 020220	001 181
05 008710	001 13	05 017010	001 9	05 020069	001 179	05 020221	001 182

货号	页数	货号	页数	货号	页数	货号	页数
05 020228 001	185	05 021728 001	199	05 022604 001	203	05 022698 001	201
05 020229 001	186	05 021737 001	197	05 022606 001	203	05 022699 001	192
05 020230 001	183	05 021909 001	196	05 022608 001	203	05 022700 001	202
05 020231 001	183	05 021909 001	280	05 022610 001	203	05 022701 001	202
05 020232 001	182	05 022040 001	204	05 022612 001	203	05 022702 001	202
05 020233 001	186	05 022041 001	204	05 022614 001	203	05 022703 001	202
05 020234 001	186	05 022042 001	204	05 022616 001	203	05 022704 001	202
05 020235 001	186	05 022043 001	204	05 022630 001	203	05 022705 001	202
05 020240 001	185	05 022044 001	204	05 022631 001	203	05 022706 001	202
05 020241 001	183	05 022045 001	204	05 022632 001	203	05 022708 001	202
05 020259 001	181	05 022046 001	204	05 022633 001	203	05 022709 001	202
05 020260 001	181	05 022047 001	204	05 022634 001	203	05 022710 001	202
05 020261 001	181	05 022048 001	204	05 022635 001	203	05 022711 001	202
05 020262 001	181	05 022050 001	204	05 022636 001	203	05 022712 001	202
05 020263 001	181	05 022052 001	204	05 022637 001	203	05 022713 001	202
05 020264 001	181	05 022054 001	204	05 022638 001	203	05 022714 001	202
05 020302 001	183	05 022056 001	204	05 022639 001	195	05 022715 001	202
05 020310 001	189	05 022058 001	204	05 022640 001	195	05 022716 001	202
05 020311 001	189	05 022060 001	204	05 022641 001	195	05 022717 001	202
05 020312 001	189	05 022062 001	204	05 022651 001	203	05 022718 001	202
05 020313 001	189	05 022063 001	204	05 022652 001	203	05 022720 001	192
05 020314 001	189	05 022064 001	204	05 022653 001	203	05 022721 001	193
05 020500 001	181	05 022066 001	204	05 022654 001	203	05 022728 001	57
05 020501 001	181	05 022067 001	204	05 022655 001	203	05 022729 001	56
05 020502 001	181	05 022068 001	204	05 022656 001	203	05 022730 001	56
05 020503 001	181	05 022070 001	204	05 022657 001	203	05 022731 001	56
05 020504 001	181	05 022071 001	204	05 022658 001	203	05 022732 001	56
05 020505 001	181	05 022072 001	204	05 022659 001	203	05 022733 001	56
05 020506 001	181	05 022073 001	204	05 022660 001	201	05 022734 001	56
05 020507 001	181	05 022074 001	204	05 022661 001	201	05 022740 001	56
05 021005 001	205	05 022076 001	204	05 022662 001	201	05 022741 001	56
05 021010 001	205	05 022078 001	204	05 022663 001	201	05 022745 001	57
05 021015 001	205	05 022079 001	204	05 022664 001	201	05 022760 001	57
05 021020 001	205	05 022080 001	204	05 022665 001	201	05 022761 001	57
05 021025 001	205	05 022081 001	204	05 022666 001	201	05 022762 001	57
05 021030 001	205	05 022082 001	204	05 022667 001	201	05 022763 001	57
05 021035 001	205	05 022086 001	197	05 022668 001	201	05 022764 001	57
05 021040 001	205	05 022087 001	196	05 022669 001	192	05 022765 001	57
05 021045 001	205	05 022089 001	193	05 022670 001	203	05 022766 001	57
05 021050 001	205	05 022095 001	204	05 022671 001	203	05 022767 001	57
05 021055 001	205	05 022096 001	204	05 022672 001	203	05 022795 001	15
05 021060 001	205	05 022101 001	198	05 022673 001	203	05 022800 001	15
05 021065 001	205	05 022102 001	198	05 022674 001	203	05 022805 001	15
05 021070 001	205	05 022120 001	205	05 022675 001	203	05 022810 001	15
05 021075 001	205	05 022121 001	205	05 022676 001	203	05 022815 001	15
05 021080 001	205	05 022122 001	205	05 022677 001	203	05 022820 001	15
05 021085 001	205	05 022123 001	205	05 022678 001	203	05 022825 001	15
05 021090 001	205	05 022124 001	205	05 022680 001	209	05 022830 001	15
05 021095 001	205	05 022125 001	205	05 022681 001	209	05 022835 001	15
05 021406 001	197	05 022130 001	196	05 022682 001	209	05 022850 001	202
05 021600 001	205	05 022171 001	200	05 022683 001	209	05 022851 001	202
05 021605 001	205	05 022181 001	198	05 022684 001	209	05 022852 001	202
05 021610 001	205	05 022200 001	202	05 022685 001	209	05 022853 001	202
05 021615 001	205	05 022201 001	202	05 022686 001	209	05 022854 001	202
05 021620 001	205	05 022202 001	202	05 022687 001	209	05 022855 001	202
05 021625 001	205	05 022203 001	202	05 022688 001	209	05 022856 001	202
05 021630 001	205	05 022204 001	202	05 022689 001	207	05 022857 001	202
05 021632 001	205	05 022205 001	202	05 022693 001	201	05 022858 001	202
05 021635 001	205	05 022210 001	193	05 022694 001	201	05 022860 001	195
05 021640 001	205	05 022534 001	196	05 022695 001	201	05 022905 001	15
05 021645 001	205	05 022600 001	203	05 022696 001	201	05 022910 001	15
05 021721 001	199	05 022602 001	203	05 022697 001	201	05 022920 001	15

货号索引

货号	页数	货号	页数	货号	页数	货号	页数
05 023105 001	14	05 023450 001	43	05 024401 001	9	05 027105 001	204
05 023107 001	14	05 023451 001	44	05 024402 001	9	05 027106 001	204
05 023110 001	14	05 023452 001	45	05 024403 001	9	05 027107 001	204
05 023115 001	14	05 023453 001	43	05 024404 001	9	05 027108 001	204
05 023120 001	14	05 023454 001	44	05 024405 001	9	05 027109 001	204
05 023125 001	14	05 023456 001	45	05 024410 001	11	05 027110 001	204
05 023130 001	14	05 023460 001	42	05 024450 001	207	05 027111 001	204
05 023330 001	39	05 023461 001	42	05 024451 001	210	05 027201 001	206
05 023332 001	39	05 023470 001	229	05 024452 001	210	05 027202 001	206
05 023334 001	40	05 023471 001	228	05 024453 001	210	05 027203 001	206
05 023338 001	40	05 024001 001	211	05 024454 001	210	05 027204 001	206
05 023339 001	40	05 024002 001	211	05 024455 001	210	05 027205 001	206
05 023340 001	40	05 024003 001	211	05 024456 001	210	05 027206 001	206
05 023342 001	40	05 024004 001	211	05 024457 001	210	05 027207 001	206
05 023343 001	40	05 024005 001	211	05 024458 001	210	05 027208 001	206
05 023344 001	40	05 024008 001	211	05 024459 001	210	05 027209 001	206
05 023346 001	40	05 024010 001	211	05 024460 001	208	05 027210 001	206
05 023347 001	40	05 024012 001	211	05 024461 001	211	05 027211 001	206
05 023348 001	40	05 024013 001	211	05 024462 001	211	05 027212 001	206
05 023350 001	40	05 024015 001	211	05 024463 001	211	05 027213 001	206
05 023351 001	40	05 024020 001	211	05 024464 001	210	05 027214 001	206
05 023352 001	40	05 024100 001	211	05 024465 001	210	05 027215 001	206
05 023353 001	40	05 024105 001	211	05 024466 001	210	05 027405 001	29
05 023354 001	40	05 024160 001	211	05 024467 001	210	05 027450 001	49
05 023355 001	40	05 024161 001	211	05 024468 001	210	05 027455 001	29
05 023356 001	40	05 024162 001	211	05 024469 001	210	05 027456 001	35
05 023357 001	40	05 024163 001	211	05 024470 001	207	05 027910 001	393
05 023358 001	40	05 024164 001	211	05 024471 001	209	05 027911 001	393
05 023359 001	40	05 024165 001	211	05 024472 001	209	05 027912 001	393
05 023360 001	40	05 024166 001	211	05 024473 001	209	05 027913 001	393
05 023361 001	40	05 024167 001	211	05 024474 001	209	05 027930 001	393
05 023362 001	40	05 024168 001	211	05 024475 001	209	05 027931 001	393
05 023363 001	40	05 024170 001	209	05 024476 001	209	05 027932 001	393
05 023364 001	40	05 024171 001	209	05 024477 001	209	05 027933 001	393
05 023365 001	40	05 024172 001	209	05 024478 001	209	05 027934 001	393
05 023366 001	40	05 024173 001	209	05 024479 001	209	05 027935 001	393
05 023367 001	40	05 024174 001	209	05 024480 001	207	05 027936 001	394
05 023368 001	40	05 024175 001	209	05 024481 001	210	05 028000 001	16
05 023369 001	40	05 024176 001	209	05 024482 001	210	05 028001 001	16
05 023370 001	40	05 024177 001	209	05 024483 001	210	05 028002 001	16
05 023371 001	40	05 024178 001	209	05 024484 001	209	05 028003 001	16
05 023372 001	40	05 024179 001	207	05 024485 001	209	05 028004 001	16
05 023373 001	40	05 024199 001	211	05 024486 001	209	05 028005 001	16
05 023374 001	40	05 024200 001	211	05 024487 001	209	05 028008 001	16
05 023375 001	40	05 024202 001	211	05 024488 001	209	05 028010 001	16
05 023376 001	40	05 024204 001	211	05 024489 001	209	05 028012 001	16
05 023377 001	40	05 024206 001	211	05 026350 001	28	05 028013 001	16
05 023378 001	40	05 024208 001	211	05 026351 001	28	05 028015 001	16
05 023379 001	40	05 024210 001	211	05 026352 001	28	05 028020 001	16
05 023380 001	40	05 024242 001	208	05 026353 001	28	05 028029 001	17
05 023381 001	41	05 024244 001	207	05 026354 001	28	05 028030 001	17
05 023382 001	41	05 024335 001	208	05 026360 001	28	05 028031 001	17
05 023383 001	41	05 024350 001	210	05 026361 001	28	05 028032 001	17
05 023384 001	41	05 024351 001	210	05 026363 001	28	05 028033 001	17
05 023385 001	41	05 024352 001	210	05 026372 001	28	05 028034 001	17
05 023386 001	41	05 024353 001	210	05 026373 001	28	05 028035 001	17
05 023387 001	41	05 024354 001	210	05 026374 001	28	05 028036 001	17
05 023389 001	41	05 024355 001	210	05 026382 001	28	05 028037 001	17
05 023391 001	41	05 024356 001	210	05 027101 001	204	05 028038 001	17
05 023393 001	41	05 024357 001	210	05 027102 001	204	05 028040 001	394
05 023400 001	254	05 024358 001	210	05 027103 001	204	05 028041 001	394
05 023404 001	41	05 024400 001	9	05 027104 001	204	05 028042 001	394

货号	页数	货号	页数	货号	页数	货号	页数
05 028043 001	394	05 030100 001	47	05 032031 001	7	05 051065 001	234
05 028044 001	394	05 030101 001	47	05 032032 001	7	05 051066 001	235
05 028045 001	394	05 030102 001	47	05 032033 001	7	05 051205 001	250
05 028046 001	394	05 030103 001	47	05 032050 001	7	05 051272 001	249
05 028048 001	15	05 030104 001	47	05 032051 001	7	05 051273 001	52
05 028049 001	15	05 030105 001	47	05 032052 001	7	05 051274 001	250
05 028050 001	15	05 030106 001	47	05 032053 001	7	05 051276 001	35
05 028051 001	15	05 030107 001	47	05 032054 001	7	05 051461 001	251
05 028052 001	15	05 030108 001	47	05 032055 001	7	05 051462 001	249
05 028053 001	15	05 030109 001	48	05 032056 001	7	05 051464 001	52
05 028054 001	15	05 030110 001	47	05 032057 001	7	05 051465 001	248
05 028055 001	15	05 030111 001	47	05 032058 001	7	05 051482 001	248
05 028056 001	15	05 030112 001	47	05 032060 001	7	05 051492 001	247
05 028059 001	25	05 030113 001	48	05 032061 001	7	05 051493 001	247
05 028062 001	25	05 030114 001	48	05 032063 001	8	05 051500 001	338
05 028070 001	15	05 030115 001	48	05 032070 002	7	05 051501 001	338
05 028071 001	15	05 030116 001	48	05 032071 002	7	05 051502 001	338
05 028072 001	15	05 030117 001	47	05 033404 001	29	05 051510 001	219
05 028073 001	15	05 030118 001	47	05 040001 001	254	05 051511 001	220
05 028074 001	25	05 030119 001	47	05 042605 001	343	05 051512 001	220
05 028148 001	18	05 030120 001	48	05 042655 001	343	05 051575 001	85
05 028150 001	18	05 030121 001	48	05 042665 001	343	05 051576 001	85
05 028152 001	18	05 030122 001	48	05 042670 001	342	05 051580 001	84
05 028160 001	249	05 030135 001	48	05 042671 001	342	05 051582 001	84
05 028161 001	249	05 030150 001	49	05 042672 001	342	05 051583 001	84
05 028205 001	18	05 030151 001	49	05 042673 001	342	05 051587 001	84
05 028210 001	18	05 030158 001	48	05 042674 001	342	05 051601 001	85
05 028215 001	18	05 030159 001	48	05 042680 001	342	05 051603 001	85
05 028220 001	18	05 030160 001	33	05 042705 001	343	05 051611 001	85
05 028225 001	18	05 030170 001	51	05 042715 001	343	05 051613 001	85
05 028230 001	18	05 030180 001	51	05 042750 001	343	05 051835 001	254
05 029405 001	18	05 030181 001	38	05 042755 001	343	05 052490 001	336
05 029410 001	18	05 030330 001	49	05 042760 001	343	05 052500 001	336
05 029415 001	18	05 030331 001	49	05 042765 001	343	05 052501 001	337
05 029420 001	18	05 030400 001	48	05 042768 001	343	05 052502 001	336
05 029425 001	18	05 030401 001	48	05 050005 001	103	05 052503 001	336
05 029430 001	18	05 030402 001	48	05 050205 001	341	05 052504 001	336
05 029435 001	18	05 030403 001	48	05 050210 001	341	05 052575 001	338
05 029440 001	18	05 030404 001	48	05 050215 001	341	05 053425 001	339
05 029445 001	18	05 030405 001	48	05 050220 001	341	05 053455 001	339
05 029450 001	18	05 030406 001	48	05 050510 001	341	05 053457 001	339
05 029460 001	19	05 030410 001	49	05 050650 001	341	05 053458 001	339
05 029461 001	19	05 030411 001	49	05 051005 001	250	05 053459 001	339
05 029462 001	19	05 030412 001	49	05 051010 001	21	05 053520 001	337
05 029463 001	19	05 030413 001	49	05 051011 001	22	05 053522 001	337
05 029464 001	19	05 030414 001	49	05 051012 001	20	05 053870 001	337
05 029465 001	19	05 030415 001	49	05 051016 001	216	05 053872 001	337
05 029466 001	19	05 030416 001	49	05 051017 001	217	05 053923 001	335
05 029501 001	19	05 030417 001	49	05 051021 001	217	05 056064 001	315
05 029502 001	19	05 030418 001	49	05 051024 001	218	05 056066 001	315
05 029503 001	19	05 032001 001	6	05 051025 001	218	05 056068 001	315
05 029504 001	19	05 032002 001	6	05 051028 001	218	05 056158 001	360
05 029505 001	19	05 032003 001	6	05 051030 001	252	05 056159 001	358
05 029506 001	19	05 032004 001	6	05 051031 001	252	05 056161 001	357
05 029507 001	19	05 032005 001	6	05 051032 001	219	05 056164 001	358
05 029510 001	26	05 032006 001	6	05 051040 001	251	05 056168 001	360
05 030080 001	49	05 032007 001	6	05 051041 001	251	05 056172 001	314
05 030081 001	49	05 032020 001	6	05 051042 001	224	05 056174 001	314
05 030082 001	49	05 032021 001	6	05 051043 001	52	05 056176 001	314
05 030083 001	49	05 032022 001	6	05 051045 001	98	05 056200 001	315
05 030084 001	49	05 032023 001	6	05 051060 001	234	05 056203 001	315
05 030099 001	47	05 032030 001	7	05 051061 001	235	05 056210 001	315

货号索引

货号	页数	货号	页数	货号	页数	货号	页数
05 056220 001	315	05 056681 001	318	05 057450 001	355	05 057705 001	294
05 056225 001	315	05 056682 001	318	05 057460 001	227	05 057710 001	294
05 056233 001	315	05 056683 001	318	05 057470 001	228	05 057715 001	294
05 056240 001	315	05 056684 001	318	05 057471 001	238	05 057720 001	294
05 056294 001	360	05 056685 001	318	05 057472 001	54	05 057750 001	289
05 056295 001	359	05 056686 001	318	05 057473 001	229	05 057751 001	286
05 056296 001	359	05 056687 001	318	05 057474 001	230	05 057752 001	284
05 056303 001	318	05 056700 001	296	05 057480 001	215	05 057760 001	299
05 056305 001	318	05 056702 001	296	05 057481 001	79	05 057761 001	297
05 056310 001	318	05 056704 001	296	05 057482 001	214	05 057762 001	297
05 056315 001	318	05 056710 001	297	05 057483 001	214	05 057763 001	295
05 056320 001	318	05 056712 001	297	05 057490 001	69	05 057770 001	307
05 056325 001	318	05 056714 001	297	05 057505 001	322	05 057772 001	303
05 056330 001	318	05 056720 001	297	05 057510 001	322	05 057773 001	307
05 056332 001	318	05 056722 001	297	05 057515 001	322	05 057775 001	303
05 056335 001	318	05 056724 001	297	05 057520 001	322	05 057776 001	303
05 056340 001	318	05 056805 001	298	05 057525 001	322	05 057777 001	306
05 056341 001	322	05 056810 001	298	05 057530 001	322	05 057778 001	306
05 056342 001	322	05 056812 001	298	05 057603 001	317	05 057790 001	324
05 056343 001	322	05 056815 001	298	05 057604 001	317	05 057900 001	356
05 056344 001	322	05 056820 001	298	05 057605 001	317	05 057908 001	356
05 056345 001	322	05 056825 001	298	05 057606 001	317	05 058005 001	302
05 056346 001	322	05 056835 001	298	05 057615 001	284	05 058010 001	302
05 056350 001	319	05 056910 001	298	05 057616 001	284	05 058015 001	302
05 056352 001	319	05 056915 001	298	05 057617 001	284	05 058020 001	302
05 056354 001	319	05 056925 001	298	05 057620 001	295	05 059293 001	222
05 056356 001	319	05 057113 001	226	05 057621 001	295	05 059294 001	224
05 056358 001	319	05 057114 001	226	05 057622 001	295	05 059295 001	223
05 056374 001	352	05 057115 001	358	05 057623 001	303	05 059297 001	225
05 056375 001	357	05 057122 001	355	05 057624 001	303	05 059298 001	221
05 056400 001	285	05 057150 001	329	05 057625 001	303	05 059299 001	221
05 056402 001	285	05 057151 001	329	05 057626 001	303	05 059305 001	316
05 056404 001	285	05 057152 001	329	05 057627 001	303	05 059307 001	316
05 056410 001	285	05 057153 001	329	05 057628 001	303	05 059310 001	316
05 056412 001	285	05 057160 001	329	05 057631 001	324	05 059315 001	316
05 056414 001	285	05 057161 001	329	05 057632 001	324	05 059320 001	316
05 056420 001	286	05 057162 001	329	05 057644 001	319	05 059325 001	316
05 056422 001	286	05 057163 001	329	05 057645 001	319	05 059330 001	316
05 056424 001	286	05 057225 001	316	05 057646 001	319	05 059335 001	316
05 056440 001	356	05 057235 001	316	05 057656 001	289	05 059337 001	316
05 056470 001	366	05 057240 001	316	05 057657 001	289	05 059340 001	316
05 056471 001	362	05 057412 001	354	05 057661 001	299	05 059345 001	316
05 056472 001	362	05 057415 001	354	05 057662 001	299	05 059450 001	316
05 056473 001	361	05 057416 001	353	05 057664 001	308	05 059451 001	316
05 056474 001	361	05 057417 001	347	05 057665 001	308	05 059452 001	316
05 056478 001	362	05 057418 001	167	05 057666 001	308	05 059453 001	316
05 056490 001	165	05 057420 001	351	05 057667 001	308	05 059466 001	316
05 056491 001	165	05 057421 001	353	05 057671 001	325	05 059472 001	316
05 056500 001	288	05 057422 001	365	05 057672 001	325	05 059478 001	316
05 056505 001	288	05 057423 001	365	05 057675 001	334	05 059480 001	316
05 056507 001	288	05 057424 001	368	05 057676 001	334	05 059486 001	316
05 056510 001	288	05 057430 001	351	05 057680 001	346	05 059488 001	316
05 056515 001	288	05 057431 001	353	05 057682 001	347	05 059489 001	316
05 056520 001	288	05 057432 001	364	05 057683 001	347	05 059490 001	316
05 056525 001	288	05 057433 001	363	05 057684 001	347	05 059492 001	316
05 056535 001	288	05 057434 001	367	05 057688 001	347	05 059496 001	316
05 056605 001	287	05 057435 001	364	05 057690 001	346	05 059500 001	316
05 056610 001	287	05 057436 001	363	05 057691 001	348	05 059530 001	290
05 056625 001	287	05 057437 001	363	05 057692 001	348	05 059532 001	290
05 056653 001	215	05 057438 001	364	05 057693 001	348	05 059534 001	290
05 056662 001	288	05 057440 001	367	05 057695 001	348	05 059540 001	291
05 056680 001	318	05 057441 001	350	05 057697 001	346	05 059542 001	291

货号	页数	货号	页数	货号	页数	货号	页数				
05 059544	001	291	05 059805	001	292	05 060140	001	312	05 060297	001	327
05 059550	001	291	05 059810	001	292	05 060141	001	312	05 060298	001	327
05 059552	001	291	05 059815	001	292	05 060142	001	312	05 060300	001	327
05 059554	001	291	05 059855	001	292	05 060143	001	312	05 060301	001	327
05 059602	001	321	05 059860	001	292	05 060144	001	312	05 060302	001	327
05 059603	001	321	05 059865	001	292	05 060145	001	312	05 060303	001	327
05 059604	001	321	05 059896	001	303	05 060146	001	312	05 060304	001	327
05 059605	001	321	05 059897	001	303	05 060147	001	326	05 060400	001	329
05 059610	001	321	05 059900	001	300	05 060148	001	326	05 060401	001	329
05 059615	001	321	05 059902	001	300	05 060149	001	326	05 060402	001	329
05 059620	001	321	05 059904	001	300	05 060150	001	326	05 060403	001	329
05 059625	001	321	05 059910	001	300	05 060155	001	326	05 060404	001	329
05 059628	001	321	05 059912	001	300	05 060160	001	326	05 060405	001	329
05 059629	001	321	05 059914	001	300	05 060165	001	326	05 060406	001	329
05 059630	001	321	05 059920	001	301	05 060170	001	326	05 060407	001	329
05 059631	001	321	05 059922	001	301	05 060175	001	326	05 060408	001	329
05 059632	001	321	05 059924	001	301	05 060180	001	326	05 060409	001	329
05 059633	001	321	05 060005	001	301	05 060182	001	326	05 060410	001	329
05 059634	001	321	05 060010	001	301	05 060184	001	326	05 060411	001	329
05 059635	001	321	05 060015	001	301	05 060185	001	310	05 060412	001	329
05 059636	001	321	05 060027	001	302	05 060186	001	310	05 060420	001	330
05 059637	001	321	05 060029	001	302	05 060187	001	310	05 060421	001	330
05 059640	001	323	05 060030	001	302	05 060188	001	310	05 060422	001	330
05 059641	001	323	05 060031	001	302	05 060189	001	310	05 060423	001	330
05 059642	001	323	05 060033	001	302	05 060190	001	310	05 060424	001	330
05 059643	001	323	05 060035	001	302	05 060191	001	310	05 060425	001	330
05 059644	001	323	05 060036	001	302	05 060192	001	310	05 060426	001	330
05 059645	001	323	05 060037	001	302	05 060193	001	310	05 060427	001	330
05 059660	001	321	05 060038	001	302	05 060194	001	310	05 060428	001	330
05 059661	001	321	05 060041	001	302	05 060195	001	310	05 060429	001	330
05 059662	001	321	05 060043	001	302	05 060196	001	310	05 060430	001	330
05 059663	001	321	05 060045	001	302	05 060197	001	310	05 060431	001	330
05 059664	001	321	05 060047	001	302	05 060198	001	310	05 060432	001	330
05 059665	001	321	05 060048	001	312	05 060199	001	310	05 060505	001	309
05 059666	001	321	05 060049	001	312	05 060200	001	310	05 060506	001	309
05 059667	001	321	05 060050	001	312	05 060201	001	310	05 060507	001	309
05 059668	001	321	05 060051	001	312	05 060202	001	310	05 060508	001	309
05 059680	001	322	05 060052	001	312	05 060210	001	330	05 060509	001	309
05 059681	001	322	05 060053	001	312	05 060215	001	330	05 060510	001	309
05 059682	001	322	05 060054	001	312	05 060220	001	330	05 060511	001	309
05 059683	001	322	05 060055	001	301	05 060225	001	330	05 064155	001	311
05 059700	001	309	05 060056	001	312	05 060230	001	330	05 064170	001	311
05 059701	001	309	05 060057	001	312	05 060235	001	330	05 064175	001	311
05 059702	001	309	05 060060	001	301	05 060237	001	330	05 065081	001	294
05 059703	001	309	05 060065	001	301	05 060238	001	330	05 065096	001	302
05 059704	001	309	05 060098	001	310	05 060240	001	330	05 065110	001	294
05 059705	001	309	05 060100	001	310	05 060255	001	330	05 065112	001	294
05 059720	001	302	05 060105	001	310	05 060260	001	330	05 065114	001	294
05 059721	001	302	05 060110	001	310	05 060265	001	330	05 065129	001	302
05 059755	001	292	05 060115	001	310	05 060272	001	329	05 065197	001	294
05 059760	001	292	05 060120	001	310	05 060274	001	329	05 066081	001	308
05 059765	001	292	05 060125	001	310	05 060276	001	329	05 066082	001	308
05 059766	001	292	05 060130	001	310	05 060278	001	329	05 066083	001	308
05 059770	001	292	05 060131	001	310	05 060280	001	329	05 066100	001	305
05 059775	001	292	05 060132	001	310	05 060281	001	329	05 066102	001	305
05 059780	001	292	05 060133	001	310	05 060282	001	329	05 066104	001	305
05 059785	001	292	05 060134	001	310	05 060283	001	329	05 066106	001	305
05 059786	001	292	05 060135	001	310	05 060284	001	329	05 066108	001	305
05 059790	001	292	05 060136	001	310	05 060286	001	329	05 066110	001	305
05 059795	001	292	05 060137	001	310	05 060288	001	329	05 066120	001	305
05 059800	001	292	05 060138	001	310	05 060290	001	329	05 066122	001	305
05 059802	001	292	05 060139	001	312	05 060296	001	327	05 066124	001	305

货号索引

货号	页数	货号	页数	货号	页数	货号	页数
05 066126 001	305	05 066495 001	306	05 066788 001	328	05 071110 001	349
05 066128 001	305	05 066496 001	306	05 066850 001	328	05 071116 001	222
05 066130 001	305	05 066497 001	311	05 066851 001	328	05 071117 001	223
05 066140 001	305	05 066498 001	311	05 066852 001	328	05 071222 001	329
05 066141 001	305	05 066499 001	311	05 066853 001	328	05 071223 001	329
05 066142 001	305	05 066500 001	311	05 066854 001	328	05 071224 001	329
05 066143 001	305	05 066505 001	311	05 066900 001	311	05 071225 001	329
05 066144 001	305	05 066510 001	311	05 066901 001	311	05 071228 001	329
05 066145 001	305	05 066515 001	311	05 066902 001	311	05 072014 001	426
05 066150 001	328	05 066520 001	311	05 066905 001	311	05 072017 001	426
05 066155 001	328	05 066525 001	311	05 066910 001	311	05 072050 001	315
05 066160 001	328	05 066530 001	311	05 066915 001	311	05 072055 001	315
05 066165 001	328	05 066618 001	327	05 066920 001	311	05 072057 001	315
05 066170 001	328	05 066619 001	327	05 066925 001	311	05 072059 001	315
05 066272 001	313	05 066620 001	327	05 066941 001	311	05 072061 001	315
05 066274 001	313	05 066622 001	327	05 066950 001	311	05 072063 001	315
05 066276 001	313	05 066624 001	327	05 071010 001	284	05 072065 001	315
05 066278 001	313	05 066626 001	327	05 071011 001	284	05 072070 001	288
05 066279 001	313	05 066628 001	327	05 071012 001	284	05 072072 001	288
05 066280 001	313	05 066630 001	327	05 071020 001	296	05 072074 001	288
05 066282 001	313	05 066632 001	327	05 071021 001	296	05 072080 001	298
05 066284 001	313	05 066633 001	327	05 071022 001	296	05 072082 001	298
05 066286 001	313	05 066634 001	327	05 071030 001	304	05 072084 001	298
05 066287 001	313	05 066635 001	327	05 071032 001	304	05 072400 001	288
05 066288 001	313	05 066638 001	327	05 071033 001	304	05 072401 001	288
05 066290 001	313	05 066640 001	327	05 071034 001	304	05 072402 001	288
05 066300 001	306	05 066642 001	327	05 071035 001	304	05 072403 001	299
05 066301 001	306	05 066644 001	327	05 071037 001	304	05 072404 001	299
05 066302 001	306	05 066646 001	327	05 071038 001	304	05 072405 001	299
05 066303 001	306	05 066654 001	328	05 071070 001	317	05 072406 001	307
05 066304 001	306	05 066656 001	328	05 071071 001	317	05 072407 001	307
05 066305 001	306	05 066660 001	328	05 071072 001	317	05 072408 001	307
05 066308 001	306	05 066662 001	328	05 071073 001	317	05 072409 001	307
05 066310 001	306	05 066664 001	328	05 071074 001	317	05 072411 001	307
05 066312 001	306	05 066666 001	328	05 071075 001	317	05 072412 001	307
05 066313 001	306	05 066668 001	328	05 071076 001	317	05 072441 001	289
05 066315 001	306	05 066670 001	328	05 071077 001	317	05 072443 001	299
05 066320 001	306	05 066672 001	328	05 071080 001	315	05 072444 001	299
05 066325 001	306	05 066674 001	328	05 071081 001	290	05 072446 001	307
05 066330 001	306	05 066676 001	328	05 071082 001	290	05 072447 001	307
05 066335 001	306	05 066678 001	328	05 071083 001	290	05 072448 001	307
05 066394 001	324	05 066680 001	328	05 071084 001	300	05 072449 001	307
05 066395 001	325	05 066682 001	328	05 071085 001	300	05 072451 001	307
05 066396 001	324	05 066683 001	328	05 071086 001	300	05 072452 001	307
05 066400 001	325	05 066684 001	328	05 071089 001	312	05 073050 001	319
05 066405 001	325	05 066685 001	328	05 071090 001	312	05 073051 001	319
05 066410 001	325	05 066686 001	328	05 071091 001	312	05 073052 001	319
05 066415 001	325	05 066687 001	328	05 071092 001	312	05 073053 001	319
05 066420 001	325	05 066688 001	327	05 071094 001	312	05 073054 001	319
05 066455 001	307	05 066690 001	327	05 071097 001	326	05 073055 001	319
05 066460 001	307	05 066692 001	327	05 071098 001	326	05 073056 001	321
05 066465 001	307	05 066694 001	327	05 071099 001	326	05 073057 001	321
05 066485 001	306	05 066696 001	327	05 071100 001	335	05 073058 001	321
05 066486 001	306	05 066758 001	328	05 071101 001	320	05 073059 001	321
05 066487 001	306	05 066760 001	328	05 071102 001	320	05 073060 001	321
05 066488 001	306	05 066762 001	328	05 071103 001	320	05 073061 001	321
05 066489 001	306	05 066764 001	328	05 071104 001	320	05 073064 001	312
05 066490 001	306	05 066766 001	328	05 071105 001	320	05 073065 001	312
05 066491 001	306	05 066768 001	328	05 071106 001	320	05 073066 001	312
05 066492 001	306	05 066785 001	328	05 071107 001	320	05 073070 001	313
05 066493 001	306	05 066786 001	328	05 071108 001	320	05 073071 001	313
05 066494 001	306	05 066787 001	328	05 071109 001	349	05 073072 001	313

货号	页数	货号	页数	货号	页数	货号	页数
05 073073	001 313	05 073339	001 297	05 073611	001 285	05 073980	001 347
05 073074	001 325	05 073340	001 306	05 073613	001 296	05 073984	001 55
05 073075	001 325	05 073342	001 319	05 073614	001 296	05 073985	001 341
05 073076	001 326	05 073344	001 319	05 073615	001 296	05 073990	001 334
05 073077	001 326	05 073346	001 306	05 073616	001 335	05 074700	001 376
05 073200	001 341	05 073357	001 339	05 073620	001 304	05 074701	001 376
05 073201	001 323	05 073370	001 298	05 073621	001 304	05 074702	001 376
05 073202	001 323	05 073371	001 298	05 073622	001 304	05 074705	001 376
05 073210	001 340	05 073372	001 298	05 073623	001 304	05 074710	001 376
05 073220	001 166	05 073373	001 298	05 073625	001 304	05 074711	001 376
05 073230	001 172	05 073375	001 306	05 073630	001 349	05 074712	001 376
05 073240	001 220	05 073376	001 306	05 073631	001 373	05 074715	001 381
05 073241	001 220	05 073380	001 299	05 073634	001 349	05 074715	010 386
05 073260	001 98	05 073391	001 196	05 073635	001 361	05 074716	001 381
05 073261	001 116	05 073401	001 338	05 073637	001 362	05 074716	010 386
05 073262	001 138	05 073404	001 360	05 073638	001 361	05 074717	001 382
05 073268	001 176	05 073406	001 359	05 073639	001 366	05 074717	010 387
05 073270	001 176	05 073410	001 357	05 073640	001 163	05 074720	001 382
05 073271	001 176	05 073416	001 358	05 073641	001 365	05 074720	010 387
05 073272	001 176	05 073418	001 352	05 073645	001 167	05 074721	001 383
05 073273	001 176	05 073419	001 354	05 073660	001 253	05 074721	010 388
05 073274	001 176	05 073420	001 335	05 073661	002 253	05 074722	001 382
05 073275	001 176	05 073421	001 336	05 073665	001 252	05 074722	010 387
05 073276	001 176	05 073470	001 310	05 073670	001 54	05 074728	001 382
05 073277	001 176	05 073471	001 310	05 073671	001 53	05 074728	010 387
05 073278	001 176	05 073472	001 310	05 073675	001 36	05 074730	001 380
05 073279	001 176	05 073473	001 310	05 073676	001 37	05 074731	001 380
05 073280	001 176	05 073474	001 310	05 073677	001 37	05 074733	001 380
05 073281	001 176	05 073495	001 331	05 073680	001 30	05 074734	001 380
05 073282	001 176	05 073500	001 330	05 073681	001 30	05 074738	001 378
05 073283	001 176	05 073501	001 330	05 073720	001 310	05 074739	001 379
05 073284	001 176	05 073502	001 330	05 073721	001 310	05 074745	001 379
05 073285	001 176	05 073503	001 330	05 073722	001 310	05 074746	001 378
05 073286	001 176	05 073504	001 330	05 073723	001 310	05 074750	001 77
05 073287	001 176	05 073505	001 330	05 073724	001 310	05 074752	001 77
05 073290	001 178	05 073506	001 330	05 073890	001 348	05 074757	001 77
05 073295	001 179	05 073507	001 330	05 073904	001 317	05 074770	001 376
05 073304	001 288	05 073508	001 330	05 073905	001 317	05 074772	001 376
05 073305	001 288	05 073509	001 330	05 073906	001 317	05 074774	001 376
05 073306	001 288	05 073510	001 330	05 073916	001 284	05 074780	001 380
05 073307	001 288	05 073511	001 336	05 073917	001 284	05 074782	001 380
05 073308	001 299	05 073520	001 293	05 073921	001 295	05 074784	001 380
05 073309	001 299	05 073521	001 293	05 073922	001 295	05 074786	001 380
05 073310	001 299	05 073522	001 293	05 073924	001 303	05 074788	001 380
05 073311	001 299	05 073523	001 302	05 073925	001 303	05 074790	001 381
05 073313	001 306	05 073524	001 302	05 073926	001 303	05 074790	010 386
05 073314	001 306	05 073525	001 302	05 073927	001 303	05 074792	001 381
05 073315	001 306	05 073526	001 310	05 073931	001 324	05 074792	010 386
05 073316	001 306	05 073527	001 310	05 073932	001 324	05 074794	001 381
05 073317	001 306	05 073528	001 310	05 073944	001 320	05 074794	010 386
05 073318	001 337	05 073529	001 310	05 073945	001 320	05 074800	001 385
05 073323	001 288	05 073530	001 310	05 073946	001 320	05 074800	010 389
05 073324	001 288	05 073531	001 310	05 073956	001 290	05 074802	001 380
05 073325	001 288	05 073540	001 249	05 073957	001 290	05 074804	001 380
05 073326	001 288	05 073541	001 248	05 073961	001 300	05 074810	001 385
05 073332	001 285	05 073544	001 193	05 073962	001 300	05 074810	010 389
05 073333	001 285	05 073593	001 194	05 073964	001 308	05 074820	001 384
05 073334	001 285	05 073594	001 197	05 073965	001 308	05 074820	010 390
05 073335	001 285	05 073596	001 197	05 073966	001 308	05 074822	001 384
05 073336	001 297	05 073598	001 208	05 073967	001 308	05 074822	010 390
05 073337	001 297	05 073599	001 208	05 073971	001 326	05 074824	001 384
05 073338	001 297	05 073610	001 285	05 073972	001 326	05 074824	010 390

货号索引

货号	页数	货号	页数	货号	页数	货号	页数
05 074826 001	384	05 078610 001	414	05 078695 001	417	05 100081 001	9
05 074826 010	390	05 078611 001	414	05 078696 001	417	05 100082 001	9
05 074828 001	384	05 078612 001	414	05 078697 001	417	05 100085 001	8
05 074828 010	390	05 078620 001	416	05 078698 001	417	05 100086 001	8
05 074840 001	383	05 078621 001	416	05 078699 001	417	05 100087 001	8
05 074840 010	389	05 078622 001	416	05 078700 001	417	05 100100 001	62
05 074842 001	383	05 078623 001	416	05 078701 001	417	05 104600 001	371
05 074842 010	389	05 078624 001	416	05 078702 001	417	05 104601 001	371
05 075604 001	398	05 078625 001	416	05 078703 001	417	05 104602 001	371
05 075605 001	398	05 078626 001	416	05 078704 001	417	05 104603 001	371
05 075610 001	401	05 078627 001	416	05 078705 001	417	05 104604 001	371
05 075611 001	401	05 078628 001	416	05 078706 001	425	05 104605 001	371
05 075620 001	402	05 078629 001	416	05 078707 001	419	05 104610 001	371
05 075621 001	402	05 078630 001	416	05 078708 001	419	05 104611 001	371
05 075622 001	403	05 078631 001	416	05 078709 001	425	05 104612 001	371
05 075623 001	405	05 078632 001	416	05 078710 001	421	05 104613 001	371
05 075624 001	405	05 078633 001	416	05 078711 001	425	05 104614 001	371
05 075625 001	406	05 078635 001	418	05 078714 001	423	05 104615 001	371
05 075626 001	406	05 078636 001	418	05 078715 001	423	05 104616 001	371
05 075630 001	405	05 078637 001	418	05 078716 001	423	05 104617 001	371
05 075631 001	407	05 078640 001	421	05 078717 001	423	05 104618 001	371
05 075651 001	407	05 078641 001	421	05 078720 001	424	05 104619 001	371
05 075652 001	407	05 078642 001	422	05 078721 001	424	05 104620 001	371
05 075653 001	408	05 078650 001	422	05 100000 001	58	05 104621 001	371
05 075654 001	408	05 078651 001	422	05 100001 001	58	05 104622 001	371
05 075655 001	408	05 078652 001	422	05 100002 001	58	05 104630 001	369
05 075656 001	409	05 078653 001	422	05 100003 001	58	05 104631 001	369
05 075657 001	409	05 078654 001	422	05 100004 001	58	05 104632 001	369
05 075670 001	411	05 078655 001	422	05 100011 001	59	05 104633 001	369
05 075670 010	411	05 078656 001	422	05 100012 001	59	05 104634 001	369
05 075671 001	411	05 078657 001	422	05 100015 001	59	05 104635 001	369
05 075671 010	411	05 078658 001	422	05 100016 001	59	05 104640 001	370
05 075672 001	412	05 078660 001	422	05 100019 001	60	05 104641 001	370
05 075672 010	412	05 078661 001	422	05 100020 001	60	05 104642 001	370
05 075673 001	412	05 078662 001	422	05 100021 001	60	05 104643 001	370
05 075673 010	412	05 078663 001	422	05 100022 001	60	05 104644 001	370
05 075680 001	404	05 078664 001	422	05 100024 001	61	05 104645 001	370
05 075681 001	404	05 078666 001	423	05 100025 001	61	05 104650 001	370
05 075800 001	395	05 078667 001	423	05 100026 001	61	05 104652 001	371
05 075801 001	395	05 078670 001	415	05 100030 001	12	05 104653 001	372
05 075810 001	391	05 078671 001	415	05 100031 001	12	05 104655 001	369
05 075815 001	392	05 078672 001	415	05 100042 001	12	05 104660 001	369
05 075830 001	396	05 078673 001	415	05 100043 001	12	05 104661 001	369
05 075831 001	396	05 078674 001	415	05 100044 001	12	05 104662 001	369
05 075832 001	397	05 078675 001	415	05 100050 001	13	05 104663 001	369
05 075840 001	391	05 078676 001	415	05 100051 001	13	05 104664 001	369
05 075850 001	393	05 078677 001	415	05 100052 001	13	05 104665 001	369
05 075851 001	392	05 078678 001	415	05 100055 001	14	05 104666 001	368
05 078200 001	419	05 078679 001	415	05 100056 001	14	05 104667 001	368
05 078205 001	420	05 078680 001	415	05 100057 001	14	05 104668 001	368
05 078210 001	420	05 078681 001	415	05 100060 001	16	05 104669 001	368
05 078345 001	420	05 078682 001	415	05 100061 001	16	05 104670 001	368
05 078600 001	414	05 078683 001	415	05 100062 001	16	05 104671 001	368
05 078601 001	414	05 078684 001	415	05 100063 001	16	05 104672 001	368
05 078602 001	414	05 078685 001	415	05 100064 001	16	05 104751 001	370
05 078603 001	414	05 078686 001	415	05 100070 001	17	05 104754 001	369
05 078604 001	414	05 078687 001	415	05 100071 001	17	05 105622 001	23
05 078605 001	414	05 078690 001	417	05 100072 001	17	05 105630 001	21
05 078606 001	414	05 078691 001	417	05 100075 001	9	05 105631 001	62
05 078607 001	414	05 078692 001	417	05 100076 001	9	05 105650 001	23
05 078608 001	414	05 078693 001	417	05 100077 001	9	05 105656 001	23
05 078609 001	414	05 078694 001	417	05 100080 001	9	05 110000 001	11

货号	页数	货号	页数	货号	页数	货号	页数				
05 110001	001	11	05 118064	001	34	05 133157	001	205	05 134678	001	313
05 110002	001	11	05 118066	001	34	05 133158	001	205	05 134679	001	313
05 110003	001	11	05 118068	001	34	05 133163	001	197	05 134680	001	313
05 110004	001	11	05 118070	001	34	05 133164	001	194	05 134681	001	313
05 110005	001	11	05 118072	001	34	05 133165	001	194	05 134682	001	313
05 110006	001	11	05 118074	001	34	05 133180	001	200	05 134683	001	313
05 110007	001	11	05 118075	001	34	05 133285	001	10	05 134684	001	313
05 110008	001	11	05 118076	001	34	05 133355	001	65	05 134685	001	313
05 110010	001	12	05 118078	001	34	05 133356	001	64	05 134686	001	313
05 110011	001	12	05 118080	001	34	05 133862	001	160	05 134687	001	313
05 110104	001	12	05 118082	001	34	05 134000	001	36	05 134688	001	313
05 110105	001	12	05 118089	001	34	05 134001	001	29	05 134690	001	313
05 117680	001	17	05 118090	001	34	05 134002	001	29	05 134691	001	313
05 117681	001	17	05 118092	001	34	05 134011	001	278	05 134695	001	313
05 117682	001	17	05 118094	001	34	05 134013	001	245	05 134698	001	314
05 117683	001	17	05 118096	001	34	05 134015	001	246	05 134699	001	314
05 117684	001	17	05 118098	001	34	05 134019	001	50	05 134700	001	314
05 117685	001	17	05 118100	001	34	05 134021	001	372	05 134701	001	314
05 117686	001	17	05 118102	001	34	05 134025	001	279	05 134702	001	314
05 117687	001	17	05 118103	001	34	05 134200	001	357	05 134703	001	314
05 117691	001	17	05 118106	001	34	05 134275	001	26	05 134704	001	314
05 117990	001	32	05 118108	001	35	05 134370	001	291	05 134705	001	314
05 117991	001	32	05 118109	001	35	05 134371	001	291	05 134706	001	314
05 117992	001	32	05 118110	001	35	05 134372	001	291	05 134707	001	314
05 117993	001	32	05 118112	001	35	05 134373	001	291	05 134720	001	314
05 117994	001	32	05 118114	001	35	05 134374	001	305	05 134722	001	314
05 117995	001	32	05 118116	001	35	05 134375	001	305	05 134723	001	314
05 117997	001	32	05 118118	001	35	05 134376	001	305	05 134732	001	314
05 118000	001	32	05 118120	001	35	05 134377	001	305	05 134740	001	310
05 118002	001	32	05 118122	001	35	05 134378	001	305	05 134800	001	326
05 118003	001	32	05 118124	001	35	05 134379	001	305	05 134801	001	326
05 118004	001	32	05 118126	001	35	05 134380	001	292	05 134802	001	326
05 118005	001	32	05 118128	001	35	05 134381	001	292	05 134805	001	326
05 118006	001	32	05 118130	001	35	05 134382	001	292	05 134806	001	326
05 118007	001	32	05 118132	001	35	05 134384	001	301	05 134807	001	326
05 118008	001	32	05 118134	001	35	05 134385	001	301	05 134905	001	288
05 118010	001	32	05 118135	001	35	05 134386	001	301	05 134906	001	291
05 118012	001	32	05 118136	001	35	05 134397	001	339	05 134907	001	291
05 118014	001	32	05 118137	001	35	05 134398	001	339	05 134910	001	291
05 118017	001	32	05 118145	001	34	05 134399	001	341	05 134911	001	291
05 118019	001	33	05 118150	001	38	05 134480	001	338	05 134913	001	291
05 118020	001	33	05 118152	001	38	05 134491	001	221	05 134914	001	291
05 118022	001	33	05 118154	001	39	05 134605	001	294	05 134915	001	291
05 118023	001	33	05 118156	001	39	05 134609	001	313	05 134919	001	286
05 118024	001	33	05 118158	001	39	05 134654	001	314	05 134920	001	286
05 118026	001	33	05 118180	001	33	05 134655	001	314	05 134921	001	286
05 118030	001	32	05 118181	001	33	05 134656	001	314	05 134929	001	291
05 118032	001	32	05 118182	001	33	05 134657	001	314	05 134930	001	291
05 118035	001	33	05 118183	001	33	05 134658	001	314	05 134931	001	291
05 118036	001	33	05 118184	001	33	05 134664	001	313	05 134932	001	291
05 118037	001	33	05 118185	001	33	05 134665	001	313	05 135003	001	298
05 118039	001	33	05 118186	001	33	05 134667	001	313	05 135005	001	287
05 118040	001	33	05 130002	001	340	05 134668	001	313	05 135008	001	286
05 118042	001	33	05 130003	001	340	05 134669	001	313	05 135009	001	287
05 118044	001	33	05 130110	001	399	05 134670	001	313	05 135017	001	298
05 118046	001	33	05 133150	001	205	05 134671	001	313	05 135040	001	289
05 118048	001	33	05 133151	001	205	05 134672	001	313	05 135041	001	289
05 118050	001	33	05 133152	001	205	05 134673	001	313	05 135060	001	318
05 118052	001	33	05 133153	001	205	05 134674	001	313	05 135068	001	318
05 118054	001	33	05 133154	001	205	05 134675	001	313	05 135069	001	318
05 118060	001	34	05 133155	001	205	05 134676	001	313	05 135070	001	318
05 118062	001	34	05 133156	001	205	05 134677	001	313	05 135071	001	318

货号索引

货号	页数	货号	页数	货号	页数	货号	页数
05 135072 001	318	05 135871 001	241	05 138257 001	16	05 203914 001	293
05 135073 001	318	05 135903 001	331	05 138258 001	16	05 204126 001	314
05 135074 001	318	05 135904 001	331	05 138259 001	16	05 221110 001	328
05 135075 001	318	05 135918 001	164	05 138260 001	16	05 223161 001	24
05 135076 001	318	05 135926 001	240	05 138261 001	16	05 259135 001	314
05 135077 001	318	05 135927 001	244	05 138262 001	16	05 300004 001	51
05 135078 001	318	05 135928 001	243	05 138263 001	16	05 308428 001	310
05 135079 001	318	05 135938 001	38	05 138264 001	16	05 311517 001	340
05 135090 001	321	05 135939 001	242	05 138265 001	16	05 319835 001	310
05 135091 001	321	05 135942 001	215	05 138266 001	16	05 320430 001	313
05 135092 001	321	05 135949 001	96	05 138268 001	16	05 320540 001	24
05 135093 001	321	05 135961 001	64	05 138269 001	16	05 323780 001	293
05 135094 001	321	05 135973 001	53	05 138270 001	16	05 323781 001	293
05 135095 001	321	05 136000 001	340	05 140310 001	255	05 324901 001	327
05 135096 001	321	05 136001 001	341	05 150101 001	259	05 326310 001	313
05 135097 001	321	05 136002 001	341	05 150102 001	260	05 328448 001	310
05 135098 001	321	05 136011 001	373	05 150103 001	260	05 332600 001	310
05 135099 001	321	05 136026 001	245	05 150104 001	261	05 332606 001	313
05 135120 001	313	05 136039 001	30	05 150105 001	261	05 332607 001	311
05 135121 001	313	05 136042 001	246	05 150106 001	262	05 332609 001	311
05 135140 001	306	05 136043 001	377	05 150110 001	262	05 332610 001	311
05 135141 001	306	05 136070 001	45	05 150111 001	263	05 340245 001	324
05 135142 001	306	05 136071 001	280	05 150112 001	263	05 340330 001	12
05 135143 001	306	05 136072 001	230	05 150113 001	264	05 344511 001	343
05 135200 001	310	05 136073 001	397	05 150114 001	264	05 344512 001	343
05 135201 001	310	05 136074 001	154	05 150115 001	265	05 344513 001	343
05 135202 001	310	05 136075 001	219	05 150116 001	265	05 344514 001	343
05 135204 001	310	05 136076 001	410	05 150120 001	266	05 344900 001	313
05 135205 001	310	05 136301 001	321	05 150121 001	266	05 345018 001	311
05 135220 001	311	05 136302 001	321	05 150122 001	267	05 345019 001	313
05 135221 001	311	05 136303 001	321	05 150123 001	267	05 345026 001	311
05 135222 001	311	05 136304 001	321	05 150124 001	268	05 345028 001	311
05 135224 001	331	05 136305 001	293	05 150130 001	258	05 345032 001	311
05 135225 001	331	05 136306 001	293	05 150140 001	268	05 345035 001	311
05 135230 001	313	05 136307 001	293	05 150150 001	269	05 345047 001	310
05 135231 001	313	05 136308 001	302	05 150151 001	270	05 345056 001	311
05 135232 001	313	05 136309 001	302	05 150152 001	271	05 345281 001	35
05 135233 001	313	05 136310 001	302	05 150180 001	272	05 345282 001	35
05 135234 001	313	05 136311 001	310	05 150181 001	272	05 345284 001	34
05 135235 001	313	05 136312 001	310	05 150182 001	272	05 345285 001	34
05 135264 001	316	05 136313 001	310	05 150183 001	273	05 345290 001	33
05 135265 001	316	05 136314 001	310	05 150184 001	273	05 345350 001	311
05 135266 001	316	05 136315 001	310	05 160785 001	97	05 345351 001	311
05 135267 001	316	05 136316 001	310	05 160821 001	314	05 345352 001	311
05 135268 001	322	05 136385 001	351	05 160830 001	310	05 346281 001	287
05 135269 001	322	05 136390 001	365	05 160885 001	321	05 346286 001	293
05 135270 001	294	05 136391 001	366	05 160895 001	294	05 346288 001	321
05 135271 001	294	05 136392 001	353	05 160896 001	292	05 346293 001	163
05 135272 001	294	05 136393 001	368	05 160899 001	292	05 347100 001	339
05 135273 001	294	05 136400 001	161	05 160901 001	294	05 347106 001	22
05 135276 001	294	05 136413 001	189	05 160908 001	294	05 347153 001	352
05 135277 001	294	05 136414 001	29	05 160917 001	313	05 347735 002	24
05 135280 001	295	05 136420 001	111	05 160924 001	339	05 347736 002	24
05 135281 001	295	05 136421 001	135	05 160956 001	313	05 347743 001	14
05 135284 001	295	05 136422 001	162	05 160976 001	339	05 347777 001	64
05 135285 001	295	05 136424 001	46	05 160977 001	339	05 347778 001	25
05 135311 001	27	05 136425 001	46	05 160979 001	339	05 350430 001	321
05 135530 001	293	05 136426 001	47	05 160981 001	339	05 350451 001	379
05 135531 001	293	05 136700 001	30	05 160983 001	291	05 380033 001	321
05 135532 001	293	05 138006 001	340	05 200496 001	311	05 380045 001	321
05 135810 001	359	05 138070 001	15	05 200995 001	166	05 380046 001	321
05 135870 001	241	05 138250 001	26	05 203913 001	293	05 380047 001	321

货号	页数	货号	页数	货号	页数	货号	页数
05 380048 001	321	05 380127 001	322	05 380200 001	293	05 670447 001	281
05 380049 001	321	05 380128 001	322	05 380201 001	293	05 670448 001	281
05 380050 001	321	05 380129 001	322	05 380202 001	293		
05 380124 001	322	05 380130 001	322	05 480172 001	287		
05 380125 001	322	05 380131 001	322	05 480222 001	298		
05 380126 001	322	05 380161 001	291	05 670446 001	281		

按項目編號索引

货号	页数	货号	页数	货号	页数
68	255	334 SK/6	22	454/7 HF Set 1	43
80	254	334/355 SK/6	23	454/7 HF Set 2	43
80 RA	251	335	11	454/10 HF Set Imperial 1	44
81	255	335 SB	12	454/10 HF Set Imperial 2	44
82	255	335/350/355/3	24	467 TORX® HF	40
83	255	335/350/355/4	24	467/7 TORX® HF Set 1	45
84	255	335/350/355/6	23	467/7 TORX® HF Set 2	45
85	255	335/350/367/7	24	495	41
86	255	335 Stubby	19	712	254
87	255	338	18	780 A	343
88/1	253	338/2	26	780 B	343
91	254	350 PH	13	780 C	343
95 Vario	254	350 SB	13	781 A	342
160 i VDE	58	350 SK	13	781 B	342
160 i VDE SB	58	350 PH Stubby	20	781 C	342
160 i/162 i/167 i/9	65	352	15	781/5 Set 1	342
160 i/165 i/7 Rack	63	354	14	784 A/1	343
160 i/168 i/6 Rack	64	355 PZ	14	784 B	343
160 i/6 Rack	63	355 SB	14	784 C	343
160 i/7 Rack	63	355 SK	13	800 S	233
160 iS VDE	58	355 Stubby	20	800/1 BDC	314
160 iS/7	64	367 TORX®	16	800/1 BTZ	315
160 iSS	58	367 TORX® SB	16	800/1 TZ	315
160 iSS/7	64	367/6 TORX®	25	800/1 Z	315
162 i VDE PH	59	367 TORX® BO	16	800/2 Z	316
162 i VDE PH SB	59	367/6 TORX® BO	26	800/4 Z	316
162 iS PH VDE	59	367 TORX® HF	15	800/9 C	316
162 iS PH/S VDE	60	367/4 TORX® HF	25	809/1 ESD Stubby	55
162 iSS PH VDE	59	367/6 TORX® HF	25	810/1 Vario	250
162 i PH/S VDE	60	367/7 TORX® HF	24	811/1 ESD Stubby	55
162 i PH/S VDE SB	60	367 TORX® Stubby	20	811/1 Stubby	250
165 i PZ VDE	59	367 TORX PLUS®	17	812/1 Vario	250
165 i PZ VDE SB	59	368	17	813	250
165 iS PZ VDE	60	368 SB	17	813 R	249
165 i PZ/S VDE	60	368 Stubby	20	813 R ESD	52
165 i PZ/S VDE SB	60	391	18	816 R	249
165 iS PZ/S VDE	61	391/3	27	816 R SB	249
165 iS PZ/S VDE # 1 + 2	65	392	249	816 R ESD	52
165 iSS PZ/S VDE	61	393 S	249	816 RA	251
167 i TORX® VDE	61	395	18	817 R	248
167 i/6 TORX® VDE	64	395 HO	19	817 R SB	248
168 i VDE	61	395 HO/3	26	817 VDE	78
168 i VDE SB	61	395 HO/7 SM	26	826 T Kraftform Turbo	215
190 i VDE	62	400 Hex	394	827 T Kraftform Turbo	79
247	62	400 i Hex	91	830	254
247 SB	62	400 TX	394	837 i RA	69
300 Hex	393	410 i VDE B	86	838 RA S	247
300 IP	394	411 A RA	42	838 RA-R M	247
300 TX	393	416 R	41	840 S	233
334	12	416 RA	42	840/1 BTZ	318
334 SB	12	454	39	840/1 IMP DC DIY	317
334/6	23	454 Imperial	40	840/1 IMP DC SB	317
334/355/6 Rack	23	454 HF	40	840/1 Z	318
334/368/6	25	454 Imperial HF	40	840/1 Z SB	319
334 SK	12	454/5 HF SHK Set 1	45	840/2 Z	322

货号	页数	货号	页数	货号	页数
840/4 IMP DC DIY	319	851/4 TZ SB	292	867/1 TORX® DIY	307
840/4 IMP DC SB	320	851/4 Z	292	867/1 TORX® DIY 100	307
840/4 Z	321	851/4 Z SB	293	867/1 TORX® HF	305
840/4 Z SB	321	851/9 C	294	867/1 TORX® SB	306
840/9 C	322	851/11	294	867/1 TZ TORX®	306
840/1 Z BO	322	851/12	294	867/1 Z TORX® W	307
840/4 Z BO	323	851/16	294	867/1 ZA TORX®	308
842/1 Z	319	851/21 J	295	867/2 Z TORX®	311
842/4	322	851/4 PH/S	302	867/4 IMP DC TORX® DIY	308
843	368	853/1 TZ ACR®	288	867/4 IMP DC TORX® SB	308
844	368	853/4 ACR®	293	867/4 Z TORX®	310
844/7	369	853/4 ACR® Harpoon	294	867/4 Z TORX® SB	310
845	369	853/4 ACR® SL	293	867/4 TORX® HF	309
845/8	369	855 S	232	867/4 TORX® KK	309
846 HSS	369	855/1 BDC	296	867/9 C TORX®	311
846/8	370	855/1 BDC SB	297	867/12 TORX®	311
847 HSS	370	855/1 BTH	297	867/15 TORX®	311
847/7 HSS	370	855/1 BTZ	297	867/1 Z TORX® BO	311
848 HSS	371	855/1 IMP DC DIY	295	867/1 Z TORX® BO SB	312
848/851/867/19	371	855/1 IMP DC SB	295	867/4 Z TORX® BO	312
849 HSS	371	855/1 RZ	298	867/4 Z TORX® BO SB	313
849/855/867/18	372	855/1 TH	298	867/4 IP TORX PLUS®	313
851 S	232	855/1 TH SB	298	867/4 IPR TORX PLUS®	314
851/1 A	286	855/1 TiN	298	867/9 C IP TORX PLUS®	313
851/1 BDC	285	855/1 TZ	298	868 S	233
851/1 BDC SB	285	855/1 Z	298	868/1 IMP DC DIY	324
851/1 BTH	285	855/1 Z DIY	299	868/1 IMP DC SB	324
851/1 BTZ	286	855/1 Z DIY 100	299	868/1 V	324
851/1 IMP DC DIY	284	855/1 Z SB	299	868/1 Z	325
851/1 IMP DC SB	284	855/2 Z	302	868/1 Z SB	325
851/1 J	289	855/4 BDC	300	868/4	326
851/1 RDC	286	855/4 BTH	300	868/4 SB	326
851/1 RH	287	855/4 BTZ	301	868/4 BTZ	326
851/1 RZ	287	855/4 IMP DC DIY	299	868/4 IMP DC DIY	325
851/1 RZ SB	287	855/4 IMP DC SB	300	868/4 IMP DC SB	326
851/1 TH	287	855/4 TH	301	868/4 V	327
851/1 TiN	287	855/4 TZ	301	869/4	329
851/1 TZ	288	855/4 TZ SB	301	869/4 M	330
851/1 TZ SB	288	855/4 Z	302	869/4 M SB	330
851/1 Z	288	855/4 Z SB	302	869/4 M SB Set A	331
851/1 Z DIY	288	855/11	302	869/9	331
851/1 Z DIY 100	289	855/12	302	870/1	340
851/1 Z SB	288	855/4 PZ/S	303	870/2	341
851/2 Z	294	857/1 Z	329	870/4	341
851/4 A	291	857/4 Z	329	870/4 A	340
851/4 BDC	290	860/1 XZN	328	870/4 SB	341
851/4 BTH	291	867 S TORX®	232	870/4/7 Set A SB	341
851/4 BTZ	291	867/1 IMP DC TORX® DIY	303	870/7	341
851/4 IMP DC DIY	289	867/1 IMP DC TORX® SB	303	870/14	341
851/4 IMP DC SB	290	867/1 IP TORX PLUS®	313	871/1 TORQ-SET® Mplus 25 mm	327
851/4 J	293	867/1 IPR TORX PLUS®	314	871/1 TORQ-SET® Mplus 32 mm	327
851/4 R	292	867/1 TORX®	306	871/2 TORQ-SET® Mplus	328
851/4 RH	291	867/1 TORX® BDC	305	871/4 TORQ-SET® Mplus	328
851/4 TH	292	867/1 TORX® BDC SB	305	871/1 DC TORQ-SET® Mplus	327
851/4 TZ	292	867/1 TORX® BTZ	305	871/4 DC TORQ-SET® Mplus	327

按項目編號索引

货号	页数	货号	页数	货号	页数
872/9	328	950 PKS	205	1013 Kraftform Micro	35
875/1 TRI-WING® 25 mm	328	950 SPKL HF Multicolour	202	1013 Kraftform Micro ESD	51
875/4 TRI-WING®	328	950 SPKL Multicolour	203	1060 i VDE	84
879/4	331	950 SPKL Multicolour Imperial	203	1060 i/1062 i/6 VDE	85
881/4/1 SB	340	950 SPKS Multicolour	203	1060 i/1065 i/6 VDE	85
887/4 RR	336	950 SPKS Multicolour Imperial	203	1062 i PH VDE	85
887/4 RR SB	336	950/7 Hex-Plus 1	198	1065 i PZ VDE	85
888/4/1 K	336	950/7 Hex-Plus Magnet 1	198	1267 A TORX®	28
889/4 R	336	950/7 Hex-Plus Multicolour Magnet 1	196	1267 B TORX®	28
889/4/1	336	950/9 Hex-Plus 1	196	1267 A TORX PLUS®	28
889/4/1 F	337	950/9 Hex-Plus 1 SB	196	1267 B TORX PLUS®	28
889/4/1 K	336	950/9 Hex-Plus 2	196	1427	29
889/4/1 K SB	336	950/9 Hex-Plus 3	197	1428	29
890/4/1	338	950/9 Hex-Plus 4	197	1429	35
893/4/1 K	338	950/9 Hex-Plus 5	197	1430 ESD	380
893/4/1 K SB	338	950/9 Hex-Plus 6	197	1440/1442	30
894/4/1	337	950/9 Hex-Plus 6 SB	197	1441	30
894/4/1 K	337	950/9 Hex-Plus 7	197	1460 ESD	385, 389
895/4/1	337	950/9 Hex-Plus 8	198	1529 ESD	49
895/4/1 K	337	950/9 Hex-Plus Imperial 1	200	1550 PH ESD Micro	47
895/4/1 K SB	337	950/9 Hex-Plus Imperial 1 SB	200	1550/6 ESD Micro	51
896/4/1 SB	340	950/9 Hex-Plus Multicolour 1	193	1550 PH S ESD Micro	48
897/4 IMP R	334	950/9 Hex-Plus Multicolour 1 SB	194	1555 ESD PZ Micro	48
897/4 Impaktor	334	950/9 Hex-Plus Multicolour 2	194	1567 ESD TORX® Micro	48
897/4 Impaktor R	334	950/9 Hex-Plus Multicolour 3	194	1567 ESD TORX® HF Micro	48
897/4 R	335	950/9 Hex-Plus Multicolour HF 1	193	1567 ESD TORX® BO Micro	48
897/4 R SB	335	950/9 Hex-Plus Multicolour Imperial 1	195	1567 ESD TORX PLUS® IPR Micro	48
898/4	338	950/9 Hex-Plus Multicolour Imperial 2	195	1569 ESD Micro	49
898/9	338	950/9 Hex-Plus Multicolour Imperial 3	195	1572 ESD Micro	49
898/21	338	950/9 L Hex-Plus HF 1	196	1573 ESD Micro	49
899/3/1	339	950/13 Hex-Plus Imperial 1	199	1578 A ESD Micro	47
899/4/1	339	950/13 Hex-Plus Imperial 1 SB	199	1578 A/6 ESD Micro	51
899/4/1 SB	339	967 TORX®	211	2035 Micro	32
899/4/1 S	339	967 L TORX® HF	211	2035/6 A Micro	38
899/14/1 SB	339	967 PKL TORX®	211	2035/6 B Micro	38
917 SPH	9	967 PKXL TORX®	210	2050 Micro	33
917 SPH SB	9	967 SL TORX® HF	209	2050/6 Micro	38
917 SPHS	9	967 SPKXL TORX® Multicolour	209	2052 Micro	34
918 SPZ	9	967 SXL HF TORX® Multicolour	209	2052/6 Micro	39
918 SPZ SB	9	967 SXL TORX® Multicolour	210	2054 Micro	34
921	232	967 XL HF TORX®	210	2055 Micro	32
932 A	8	967 XL TORX®	211	2067 TORX® Micro	33
932 A SB	8	967/9 TX 1	208	2067 TORX® Micro HF	33
932 AS	8	967/9 TX 1 SB	208	2067 TORX® BO Micro	33
932/6	10	967/9 TX HF 1	207	2067/6 TORX® BO Micro	39
932 S/6	10	967/9 TX Multicolour HF 1	207	2067 TORX PLUS® IPR Micro	33
932/918/6	10	967/9 TX XL 1	208	2069 Micro	35
950	205	967/9 TX XL HF 1	207	2069/6 Micro	39
950 BM	206	967/9 TX XL Multicolour 1	207	2072 Micro	34
950 L	205	967/9 TX XL Multicolour HF 1	207	2090	426
950 L HF	205	967 SPKL TORX® BO Multicolour	210	2090/17	426
950 PKL	204	967/9 TORX® BO Multicolour 1	208	3160 i VDE	56
950 PKL BM	204	967/9 TORX® BO Multicolour 1 SB	208	3160 i/7 Rack	57
950 PKL Imperial	204	977 TORX®	9	3162 i VDE	56
950 PKLS	204	977/6 TORX®	11	3165 i VDE	56

货号	页数	货号	页数	货号	页数
3165 i/6 Rack	57	6001 Joker Switch 11 Set 1	180	7774/3	422
3167 i VDE TORX®	57	6002 Joker Double	181	7775	422
3167 i/7 Rack	57	6003 Joker	181, 182	7776	422
3334	6	6003 Joker 4 Set 1	185	7779/1	423
3334/6	7	6003 Joker 4 Imperial Set 1	186	7779/2	423
3334/3350/3355/6	8	6003 Joker 5 Set 1	183	7780	415
3334/3355/6	7	6003 Joker 5 Imperial Set 1	185	7781	417
3335	6	6003 Joker 8 Imperial Set 1	183	7782 C	419
3350 PH	6	6003 Joker Pedal	182	7782 E	419
3355 PZ	7	6003 Joker 11 Set 1	183	7783 C	420
3367	7	6003 Joker 15 Set 1	183	7783 E	421
3368	7	6003 Joker 22 Set 1	182	7786	423
3800/4	315	6004 Joker L	188	7790/1	424
3816 R	248	6004 Joker M	187	7790/2	424
3817 VDE Stainless	66	6004 Joker S	187	7880 Joker L	414
3840/1 TS	317	6004 Joker XL	188	7880 Joker XL	413
3840/4	320	6004 Joker XS	187	7880 Joker XXL	413
3851/1 TS PH	284	6004 Joker XXL	188	8000 A	98
3851/1 TS PH SB	285	6004 Joker 4 Set 1	188	8000 A SB	98
3851/4 PH	290	6004 Joker VDE L	91	8000 B	115
3855/1 TS PZ	296	6004 Joker VDE M	91	8000 B SB	116
3855/1 TS PZ SB	296	6004 Joker VDE S	91	8000 C	138
3855/4 PZ	300	6004 Joker VDE XS	90	8000 C SB	138
3867/1 TS TORX®	304	6004 Joker VDE 4 Set 1	90	8000 E	161
3867/1 TS TORX® SB	304	6005 Joker 4 Set 1	189	8001 A SB	172
3867/4 TORX® BO	312	6005 Joker Double	189	8002 C KOLOSS All Inclusive Set	160
3868/4	326	7400	376, 381, 382,	8002 C KOLOSS Set	160
3869/4	329		383, 386, 387,	8003 A	100
3888/4/1 K	335		388	8003 B	119
3888/4/1 K SB	335	7400 ESD	380, 383, 384,	8003 C	141
3950 PKL	202		389,390	8004 A	101
3950 PKL Imperial	202	7400 VDE		8004 B	121
3950 SPKL Multicolour	201	7440/41		8004 C	142
3950 SPKL Multicolour HF	201	7440/41/42		8005	172
3950 SPKL Multicolour Imperial	202	7443/12		8006 C	139
3950/9 Hex-Plus Imperial Stainless 1	193	7443/61/9		8006 SC 1	139
3950/9 Hex-Plus Multicolour HF		7445/46/47		8007 B VDE	87
Stainless 1	192	7510		8008 A	173
3950/9 Hex-Plus Multicolour Imperial		7510/14		8009 Zyklop Pocket Set 1	156
Stainless 1	195	7515		8009 Zyklop Pocket Set 2	157
3950/9 Hex-Plus Multicolour Stainless 1	192	7515/7		8009 Zyklop Pocket Set 3	159
3950/9 Hex-Plus Stainless 1	192	7515/16		8009 Zyklop Pocket Set 4	159
3950/9 Hex-Plus Stainless 1 SB	193	7761		8009 Zyklop Pocket Imperial Set 1	156
3967 SXL HF TORX® Multicolour	209	7762		8009 Zyklop Pocket Imperial Set 2	158
3967/9 TX SXL Multicolour HF Stainless 1	207	7763		8010 B	117
6000 Joker	176	7770		8100 SA All-In	94
6000 Joker 4 Imperial Set 1	179	7771		8100 SA 2	96
6000 Joker 4 Set 1	178	7772 A		8100 SA 4	97
6000 Joker 8 Imperial Set 1	178	7772 B		8100 SA 6	95
6000 Joker 11 Set 1	178	7772 C		8100 SA 7	99
6000/6002 Joker 6 Set 1	178	7773 A		8100 SA 8	100
6001 Joker Switch	179	7773 B		8100 SA 9	95
6001 Joker Switch 4 Set 1	180	7773 C		8100 SA 10	99
6001 Joker Switch 4 Imperial Set 1	180	7774/1		8100 SA 11	101
6001 Joker Switch 8 Imperial Set 1	180	7774/2		8100 SA 12 HF	101

按項目編號索引

货号	页数	货号	页数	货号	页数
8100 SA/SC 2	97	8789 B	134	9602	162
8100 SB All-in	112	8789 C	155	9604	46
8100 SB HF 1	121	8790 B Impaktor	122	9605	46
8100 SB VDE 1	86	8790 B VDE	88	9606	47
8100 SB 2	114	8790 C HF 1	147	9607	123
8100 SB 4	114	8790 C Impaktor	142	9608	124
8100 SB 6	113	8790 C Impaktor Deep	144	9610	189
8100 SB 7	118	8790 C Impaktor Deep Set 1	144	9611	29
8100 SB 8	120	8790 C Wheel Impaktor	147	9630	177
8100 SB 9	113	8790 FA	173	9631	177
8100 SB 10	119	8790 HMA	102	9632	177
8100 SB 11	121	8790 HMA Deep	105	9640	186
8100 SB 12	116	8790 HMA HF	102	9641	186
8100 SB 13	117	8790 HMB	122	9642	186
8100 SC 2	137	8790 HMB Deep	126	9650	20
8100 SC 4	138	8790 HMB HF	123	9700	258
8100 SC 6	136	8790 HMC	145	9710	259
8100 SC 7	140	8790 HMC Deep	148	9711	260
8100 SC 8	141	8790 HMC Deep Open	149	9712	260
8100 SC 9	137	8790 HMC HF	145	9713	261
8100 SC 10	141	8794 A	111	9714	261
8100 SC 11	142	8794 B	134	9715	262
8700 A FL	109	8794 C	155	9720	262
8740 A	108	8794 LA	110	9721	263
8740 A HF	108	8794 LB	134	9722	263
8740 A HF 1	109	8794 LB VDE	89	9723	264
8740 B	130	8794 LC	154	9724	264
8740 B HF	130	8794 SA	110	9725	265
8740 B HF 1	131	8794 SB	134	9726	265
8740 B HF Imperial 1	132	8794 SB VDE	89	9730	266
8740 B VDE HF	88	8794 SC	155	9731	266
8740 C HF	152	8795 A	110	9732	267
8740 C HF 1	153	8795 B	134	9733	267
8740 C HF 2	153	8795 C	155	9734	268
8751 A	109	8796 LA	109	9740	268
8755 A	109	8796 LB	133	9750	269
8760 B VDE XZN	88	8796 LC	154	9751	270
8767 A	106	8796 SA	110	9752	271
8767 A HF	106	8796 SB	133	9780	272
8767 A HF 1	107	8796 SC	154	9781	272
8767 B	128	8797 C	140	9782	272
8767 B HF	128	9100	246	9783	273
8767 B HF 1	129	9108/2	30	9784	273
8767 B VDE HF	88	9200	340	Belt A 0/8	111
8767 C HF	150	9500	29	Belt A 0/9	111
8767 C HF 1	151	9506 SB	323	Belt A 1	103
8767 C HF 2	151	9507 SB	323	Belt A 2	108
8767 C HF 3	152	9514 ESD	55	Belt A 3	107
8780 C	161	9523	30	Belt A 4	103
8781 C	161	9524	377	Belt A Deep 1	105
8782 C	161	9529 C SB	154	Belt A Imperial 1	104
8784 A1	111	9530	410	Belt B 0/8	135
8784 B1	134	9532	246	Belt B 0/9	135
8784 C2	155	9600	111	Belt B 1	124
8789 A	110	9601	135	Belt B 2	131

货号	页数	货号	页数	货号	页数
Belt B 3	129	Bit-Check 6 V Universal 1	362	Bit-Check 30 Metal 1 SB	367
Belt B 4	125	Bit-Check 6 Wood TX HF 1	366	Bit-Check 30 Stainless 1	349
Belt B Deep 1	127	Bit-Check 6 Wood TX HF 1 SB	366	Bit-Check 30 TX Universal 1	356
Belt B Imperial 1	132	Bit-Check 7 Diamond 1	353	Bit-Check 30 TX Universal 1 SB	356
Belt B VDE 0/10	89	Bit-Check 7 Diamond 1 SB	354	Bit-Check 30 Universal 1	356
Belt B VDE 1	87	Bit-Check 7 Hex-Plus 1	360	Bit-Check 30 Wood 1	363
Belt C 0/ 6	161	Bit-Check 7 PZ Diamond 1	354	Bit-Check 30 Wood 2	364
Belt C 1	146	Bit-Check 7 PZ Universal 1	359	Bit-Check 30 Wood 2 SB	364
Belt C 2	153	Bit-Check 7 TX BO Universal 1	360	Bit-Check 30 Wood TX HF 1	363
Belt C 3	150	Bit-Check 7 TX Diamond 1	354	Bit-Check 30 Wood TX HF 1 SB	363
Belt C Deep 1	149	Bit-Check 7 TX Universal 1	360	Bit-Check 30 Zyklus Mini 1	163
Belt C Impaktor 0/9	162	Bit-Check 7 TX Universal 1 SB	360	Bit-Check 30 Zyklus Mini 2	163
Belt C Impaktor 1	143	Bit-Check 7 Universal 1	359	Bit-Safe 43 Universal 1	355
Bicycle Big Pack 1	28	Bit-Check 7 Universal 1 SB	359	Bit-Safe 61 BiTorsion 1	350
Bicycle Set 1	168	Bit-Check 7 Universal 4	359	Bit-Safe 61 Universal 1	355
Bicycle Set 2	225	Bit-Check 10 BiTorsion 1	352	Click-Torque A 5	398
Bicycle Set 3	169	Bit-Check 10 BiTorsion 3 SB	352	Click-Torque A 6	398
Bicycle Set 3 A	170	Bit-Check 10 Drywall 1	373	Click-Torque A 6 Set 1	399
Bicycle Set 4	200	Bit-Check 10 Impaktor 1	346	Click-Torque B 1	401
Bicycle Set 5	239	Bit-Check 10 Impaktor 1 SB	347	Click-Torque B 2	401
Bicycle Set 6	46	Bit-Check 10 Impaktor 2	347	Click-Torque C 1	402
Bicycle Set 7	115	Bit-Check 10 Impaktor 3	347	Click-Torque C 2	402
Bicycle Set 8	133	Bit-Check 10 Impaktor 4	347	Click-Torque C 2 Push R/L	406
Bicycle Set 9	171	Bit-Check 10 PZ BiTorsion 2	352	Click-Torque C 3	403
Bicycle Set 10	184	Bit-Check 10 PZ Impaktor 1	347	Click-Torque C 3 Push R/L	406
Bicycle Set 11	239	Bit-Check 10 Stainless 1	349	Click-Torque C 3 Set 1	404
Bicycle Set 12	184	Bit-Check 10 Stainless 1 SB	349	Click-Torque C 3 Set 2	404
Bicycle Set 13	31	Bit-Check 10 TX Impaktor 1	347	Click-Torque C 4	405
Bicycle Set 15	31	Bit-Check 10 TX Universal 1	358	Click-Torque C 5	405
Bicycle Set Torque 1	400	Bit-Check 10 TX Universal 2	358	Click-Torque E 1	405
Bit-Box 15 Impaktor PH	284	Bit-Check 10 Universal 1	357	Click-Torque E 1 Push R/L	407
Bit-Box 15 Impaktor PZ	295	Bit-Check 10 Universal 2	357	Click-Torque X 1	407
Bit-Box 15 Impaktor TX	303	Bit-Check 10 Universal 3	357	Click-Torque X 2	407
Bit-Box 20 BTH PZ	297	Bit-Check 10 Universal 3 SB	357	Click-Torque X 3	408
Bit-Box 20 BTZ PH	286	Bit-Check 10 Universal 4	358	Click-Torque X 4	408
Bit-Box 20 BTZ PZ	297	Bit-Check 10 Universal 5 SB	358	Click-Torque X 5	408
Bit-Box 20 PH	289	Bit-Check 10 Zyklus Mini 1	167	Click-Torque X 6	409
Bit-Box 20 PZ	299	Bit-Check 10 Zyklus Mini BiTorsion 1	167	Click-Torque X 7	409
Bit-Box 20 TX	307	Bit-Check 12 BiTorsion 1	351	Click-Torque XP 1	411
Bit-Box 20 TX HF	306	Bit-Check 12 BiTorsion 1 SB	351	Click-Torque XP 2	411
Bit-Box 20 V Robertson	324	Bit-Check 12 Diamond 1	353	Click-Torque XP 3	412
Bit-Check 6 Impaktor 1	348	Bit-Check 12 Diamond 1 SB	353	Click-Torque XP 4	412
Bit-Check 6 Impaktor 1 SB	348	Bit-Check 12 Metal 1	368	K 50	281
Bit-Check 6 PH Impaktor 1	348	Bit-Check 12 Metal 1 SB	368	K 70	281
Bit-Check 6 PZ Impaktor 1	348	Bit-Check 12 Wood 1	365	K 120	281
Bit-Check 6 PZ Universal 1	362	Bit-Check 12 Wood 1 SB	365	Kraftform 2go 100	63
Bit-Check 6 SHK 1 SB	373	Bit-Check 12 Wood 2	365	Kraftform 2go 300	22
Bit-Check 6 Stainless 1	349	Bit-Check 12 Wood 2 SB	366	Kraftform Big Pack 100 VDE	62
Bit-Check 6 TX Impaktor 1	348	Bit-Check 12 Wood TX HF 1	364	Kraftform Big Pack 300	21
Bit-Check 6 TX Universal 1	362	Bit-Check 12 Wood TX HF 1 SB	365	Kraftform Big Pack 900	10
Bit-Check 6 TX Universal 1 SB	362	Bit-Check 30 BiTorsion 1	351	Kraftform Kompakt 10	215
Bit-Check 6 Universal 1	361	Bit-Check 30 Diamond 1	353	Kraftform Kompakt 12	215
Bit-Check 6 Universal 1 SB	361	Bit-Check 30 Impaktor 1	346	Kraftform Kompakt 20	217
Bit-Check 6 Universal 2	361	Bit-Check 30 Impaktor 2	346	Kraftform Kompakt 20 Tool Finder 1	216
Bit-Check 6 Universal 2 SB	361	Bit-Check 30 Metal 1	367	Kraftform Kompakt 20 Tool Finder 2	217

按項目編號索引

货号	页数	货号	页数	货号	页数
Kraftform Kompakt 25	218	Kraftform Kompakt Pistol RA 4	252	Kraftform Kompakt VDE 62 i PH/S Take it easy	81
Kraftform Kompakt 26	218	Kraftform Kompakt SH 1	244	Kraftform Kompakt VDE 62 iS PH/S	
Kraftform Kompakt 27 Set 1	219	Kraftform Kompakt SH 2	245	Take it easy	81
Kraftform Kompakt 27 Set 2	220	Kraftform Kompakt Stubby 1	238	Kraftform Kompakt VDE 64 i Take it easy	83
Kraftform Kompakt 27 Imperial Set 1	220	Kraftform Kompakt Stubby ESD 1	54	Kraftform Kompakt VDE 64 i Take it easy SB	83
Kraftform Kompakt 27 XL SHK 1	219	Kraftform Kompakt Stubby Magazin 1	237	Kraftform Kompakt VDE 65 i Take it easy	80
Kraftform Kompakt 27 XL Universal 1	218	Kraftform Kompakt Stubby Magazin 2	237	Kraftform Kompakt VDE 65 iS Take it easy	81
Kraftform Kompakt 27 XL Universal Imperial Set 1	219	Kraftform Kompakt Stubby Magazin 3	237	Kraftform Kompakt VDE 65 iS Take it easy SB	81
Kraftform Kompakt 27 RA 1 SB	253	Kraftform Kompakt Stubby Magazin 4	237	Kraftform Kompakt VDE 65 i PZ/S Take it easy	81
Kraftform Kompakt 27 RA 2 SB	253	Kraftform Kompakt Stubby Magazin 5	237	Kraftform Kompakt VDE 65 iS PZ/S	
Kraftform Kompakt 28	221	Kraftform Kompakt Stubby Magazin RA 1	236	Take it easy	82
Kraftform Kompakt 28 SB	220	Kraftform Kompakt Stubby Magazin RA 2	236	Kraftform Kompakt VDE 65 iS PZ/S	
Kraftform Kompakt 28 Imperial 1	220	Kraftform Kompakt Stubby Magazin RA 4	236	Take it easy SB	82
Kraftform Kompakt 40	221	Kraftform Kompakt Turbo 1	214	Kraftform Kompakt VDE 67 i TORX®	
Kraftform Kompakt 41	221	Kraftform Kompakt Turbo Imperial 1	214	Take it easy	82
Kraftform Kompakt 60	223	Kraftform Kompakt Turbo i 1 Tool Finder	78	Kraftform Kompakt VDE 67 i TORX®	
Kraftform Kompakt 60 ESD	52	Kraftform Kompakt Turbo i Imperial 1		Take it easy SB	82
Kraftform Kompakt 60 Imperial	224	Tool Finder	79	Kraftform Kompakt VDE 67 iS Take it easy	83
Kraftform Kompakt 60 KK	224	Kraftform Kompakt Vario RA	252	Kraftform Kompakt VDE 68 i Take it easy	83
Kraftform Kompakt 60 RA	251	Kraftform Kompakt VDE 7 extra slim 1		Kraftform Kompakt VDE 68 iS Take it easy	83
Kraftform Kompakt 60 RA Imperial	251	Tool Finder	76	Kraftform Kompakt VDE 3060 i	
Kraftform Kompakt 60 Stainless	222	Kraftform Kompakt VDE 7 Imperial 1		Take it easy SB	67
Kraftform Kompakt 60 Stainless Imperial	223	Tool Finder	77	Kraftform Kompakt VDE 3060 iS	
Kraftform Kompakt 60 Torque	222	Kraftform Kompakt VDE 7 Universal 1		Take it easy SB	67
Kraftform Kompakt 62	225	Tool Finder	77	Kraftform Kompakt VDE 3062 iS	
Kraftform Kompakt 70 Universal	226	Kraftform Kompakt VDE 7 Universal 2		Take it easy SB	67
Kraftform Kompakt 71 Security	226	Tool Finder	77	Kraftform Kompakt VDE 3065 iS PZ	
Kraftform Kompakt 96 VK 6,3	84	Kraftform Kompakt VDE 15 Torque		Take it easy SB	68
Kraftform Kompakt 97 VK 8,1	84	1,2-3,0 Nm extra slim 1 Tool Finder	71	Kraftform Kompakt VDE 3065 iS PZ/S	
Kraftform Kompakt 98 DK	84	Kraftform Kompakt VDE 16 extra slim 1		Take it easy SB	68
Kraftform Kompakt 99 FL	84	Tool Finder	75	Kraftform Kompakt VDE 3067 i TORX®	
Kraftform Kompakt 100	227	Kraftform Kompakt VDE 16 Torque		Take it easy SB	69
Kraftform Kompakt 400	228	1,2-3,0 Nm extra slim 1 Tool Finder	71	Kraftform Kompakt VDE 3067 iS TORX®	
Kraftform Kompakt 400 RA Set 1	228	Kraftform Kompakt VDE 16 Universal 1		Take it easy SB	68
Kraftform Kompakt 400 RA Set 2	229	Tool Finder	76	Kraftform Kompakt VDE Big Pack 1	72
Kraftform Kompakt 400 RA Imperial Set 1	229	Kraftform Kompakt VDE 17 extra slim 1		Kraftform Kompakt VDE Stainless 8	
Kraftform Kompakt 400 RA Imperial Set 2	230	Tool Finder	74	extra slim 1 Tool Finder	66
Kraftform Kompakt 400 RA SHK Set 1	230	Kraftform Kompakt VDE 17 RA 1	70	Kraftform Kompakt VDE Stainless 17	
Kraftform Kompakt 838 RA S Set 1	234	Kraftform Kompakt VDE 17 RA Imperial 1	70	extra slim 1 Tool Finder	65
Kraftform Kompakt 838 RA S Imperial Set 1	234	Kraftform Kompakt VDE 17 Universal 1		Kraftform Kompakt W 1	240
Kraftform Kompakt 838 RA-R M Set 1	235	Tool Finder	75	Kraftform Kompakt W 2	241
Kraftform Kompakt 838 RA-R M Imperial Set 1	235	Kraftform Kompakt VDE 18 Imperial 1		Kraftform Kompakt W Imperial 1	241
Kraftform Kompakt 900	231	Tool Finder	73	Kraftform Kompakt Zyklop	98
Kraftform Kompakt 900 Imperial Set 1	231	Kraftform Kompakt VDE 18 Universal 1		Kraftform Kompakt Zyklop Mini 2	164
Kraftform Kompakt F 1	245	Tool Finder	73	Kraftform Kompakt Zyklop MS1	
Kraftform Kompakt H 1	242	Kraftform Kompakt VDE 18 Universal 2		Metal/Speed 1/4"	96
Kraftform Kompakt M 1	243	Tool Finder	74	Kraftform Micro Big Pack 1	36
Kraftform Kompakt Micro 11 Electronics 1	37	Kraftform Kompakt VDE 60 i Take it easy	79	Kraftform Micro ESD Big Pack 1	50
Kraftform Kompakt Micro 11 ESD 1	54	Kraftform Kompakt VDE 60 i Take it easy SB	79	Kraftform Micro 12 Electronics 1	37
Kraftform Kompakt Micro 11 Universal 1	38	Kraftform Kompakt VDE 60 iS Take it easy	80	Kraftform Micro 12 Universal 1	36
Kraftform Kompakt Micro 20 ESD 1	53	Kraftform Kompakt VDE 60 iS Take it easy SB	80	Kraftform XXL	21
Kraftform Kompakt Micro 21 ESD 1	53	Kraftform Kompakt VDE 62 i Take it easy	80	Kraftform XXL 2	22
Kraftform Kompakt Pistol RA	252	Kraftform Kompakt VDE 62 iS Take it easy	80	Kraftform XXL 3	22
		Kraftform Kompakt VDE 62 iS Take it easy SB	80	M 1	103
				Rack Kraftform	29

货号	页数	货号	页数	货号	页数
Rack Kraftform Micro	29				
Safe-Torque A 1	395				
Safe-Torque A 1 Set 1	396				
Safe-Torque A 1 Imperial Set 1	396				
Safe-Torque A 1 SHK Set 1	397				
Safe-Torque A 2	395				
Safe-Torque A 2 Set 1	397				
Stubby Set 1	27				
Stubby Set 2	27				
Stubby Set 3	27				
Stubby Set TX 1	27				
T 1	372				
Tool-Check 1 SB	166				
Tool-Check Automotive 1	166				
Tool-Check PLUS	165				
Tool-Check PLUS Imperial	165				
Wera 2go 1	276				
Wera 2go 2	276				
Wera 2go 2 XL	277				
Wera 2go 3	277				
Wera 2go 4	277				
Wera 2go 5	277				
Wera 2go 6	278				
Wera 2go 7	278				
Wera 2go E 1	279				
Wera 2go H 1	278				
Wera 2go SHK 1	280				
Wheel Impaktor C Set 1	148				
Zyklop Hybrid Set	139				
套筒磁性条带 A 4	104				
套筒磁性条带 A Deep 1	106				
套筒磁性条带 A Imperial 1	104				
套筒磁性条带 B 4	125				
套筒磁性条带 B Deep 1	127				
套筒磁性条带 B Imperial 1	126				
套筒磁性条带 C 4	151				
套筒磁性条带 C Deep 1	149				
套筒磁性条带 C Impaktor 1	143				
套筒磁性条带 C Imperial 1	146				



Wera Werkzeuge GmbH
Korzterer Straße 21-25
42349 Wuppertal



+49 / (0)202 / 40 45 - 0

E-Mail: info@wera.de



Wera Tools Ibérica, S.L.
Avda. Corts Catalanes 2, Local 5
08173 Sant Cugat del Vallès, Barcelona
☎ +34/93/72 97 - 240
E-Mail: ventas@weraspain.com



Wera Tools Finland Oy
Vanha Kaarelantie 33 A
01610 Vantaa
☎ +358 45 206 9556
E-Mail: ahokas@wera.de



Wera Outillages S.A.S.
13, rue Ampère
F - 67500 Haguenau
☎ +33 9 72 61 16 52
E-Mail: info@wera-outillages.fr



Wera Tools (UK) Ltd.
Railway View
Clay Cross
Chesterfield
S45 9FR
☎ +44 (0)1246 / 27 77 56
Fax: +44 (0)1246 / 27 33 35
E-Mail: queries@wera-tools.co.uk



Wera Tools Inc.
3325 Harvester Rd., Unit 16
Burlington, Ontario
Canada, L7N 3N2
☎ 1-800-267-55 41



Wera Tools Inc.
3325 Harvester Rd., Unit 16
Burlington, Ontario
Canada, L7N 3N2
☎ 1-800-267-55 41
E-Mail: info@weratools.com



NL - Noord
Frederik Koning
☎ +31 / 615 26 36 97
E-Mail: koning@wera.de



Wera Tools Inc.
3325 Harvester Rd., Unit 16
Burlington, Ontario
Canada, L7N 3N2
☎ 1-800-267-55 41
E-Mail: info@weratools.com



Wera Tools Australia Pty Ltd
Australia
☎ +61-435 755 123
E-Mail: mike.sack@wera.de

NL - Zuid
Wouter Steijvers
☎ +31 / 652 85 01 62
E-Mail: steijvers@wera.de

NL - Midden
Martijn van Houdt
☎ +31 / 611 06 35 35
E-Mail: vanhoudt@wera.de

Demovan
Vincent van Gaalen
☎ +31 / 615 44 37 19
E-Mail: vangaalen@wera.de



Wera Tools Japan G.K
2F, Eden Bldg.,
1-10-8 Kamiikebukuro, Toshima-Ku,
Tokyo, 170-0012 Japan
東京都豊島区上池袋1-10-8
エデンビル2階
☎ +81-3-3915-2555
E-Mail メール: frank.yang@wera.de

涉及公司的注册商标

取决于技术的改良

任何出版印刷，就算是专家，也需要从维拉别克柴格公司取得授权。

版本: CN 1/2025

被使用商标:

ACR	Phillips Screw Company
ASSY	Adolf Würth GmbH & Co. KG
AW	Adolf Würth GmbH & Co. KG
HIOS	Totsu, Katsuyuki
Microstix	OSG System Products Co. Ltd.
Phillips Recess	Phillips Screw Company
Pozidriv	registered trademark for Phillips Screw Company in Canada, Mexico and in the USA; for Trifast plc in the UK
PZ	registered trademark for Phillips Screw Company in Canada, Mexico and in the USA
PZ1, PZ2, PZ3	registered trademark in the USA for Phillips Screw Company
PUK	Josef Haunstetter Sägenfabrik KG
Robertson	British Robertson S.L.U.
SDS plus	Robert Bosch GmbH
SIT	Adolf Würth GmbH & Co. KG
SPAX	Altenloh, Brinck & Co. GmbH & Co. KG
T-STAR plus	Altenloh, Brinck & Co. GmbH & Co. KG
TORQ-SET	Phillips Screw Company
TORX	Acutment Intellectual Properties, LLC, Troy, Mich., US
TORX PLUS	Acutment Intellectual Properties, LLC, Troy, Mich., US
TRI-WING	Phillips Screw Company
BESSEY®	BESSEY Tool GmbH & Co. KG
“KIRSCHEN”®	Wilh. Schmitt & Comp. GmbH & Co. KG
KNIPEX®	KNIPEX-Werk C. Gustav Putsch KG
COBRA®	KNIPEX-Werk C. Gustav Putsch KG
Lyra®	Johann Froescheis Lyra-Bleistift-Fabrik GmbH & Co. KG
PFERD	August Rüggeberg GmbH & Co. KG
PICARD®	Picard GmbH
RENNSTEIG	Rennsteig Werkzeuge GmbH
Stabila®	STABILA Messgeräte Gustav Ullrich GmbH

维拉别克柴格公司在此声明保有对产品的特征，版本，设计等等进行更新和改善的权利，无需就另外进行事前通知，同时对出版印刷的错误和瑕疵负责。



欢迎联络我们

中国经销代理

凯尼派克工具 (上海) 有限公司

Phone: +86 (0) 21-58998010

E-Mail: info@knipex.com.cn

Fax: +86 (0) 21-58998050

Internet: www.knipex.com.cn

铭沣工业自动化 (上海) 有限公司

Phone: +86 (0)21 - 66 24 91 22

E-Mail: service@matfron.com

亚洲总部

Wera Tools Japan G.K.

Phone: +81-3-3915-2555

E-Mail: frank.yang@wera.de