



Tools for Rebels





We love innovations.
We love design.
We love rock'n'roll.

We firmly believe that our tools make the life of our users simpler, safer and more “full of joy”. We are never satisfied with the existing standards.

There are very many screwdriving tools. But contrary to others, we do not feel that tools will ever reach their final stage of development. We are constantly searching for new ideas. We think differently. We question. And in this process develop screwdriving tools such as the Zyklop ratchet or the Joker wrench – innovations that are real game-changers.

1,500 Wera Tool Rebels really enjoy reinventing screwdriving tools every day and working on your problem solvers. Yet for all this fun, we are still very successful. Our rate of complaints is more or less zero. We are delighted about the many accolades from our customers and are proud of our design awards.

You would like to learn more about screwdriving tools? We are available for you worldwide and the right tool for you can surely be found from among the more than 3,000 different articles we have on offer.

Who are the Tool Rebels?

The expression Tool Rebel (from the Latin rebellis, “rebellious”) refers to someone who goes unusual ways and reinvents tools so to speak. Someone that is not satisfied with established standards and who likes to question the prevailing status quo.

The term first emerged when the screwdriving tool manufacturer Wera asked its customers what they think about the company. Many customers refer to Wera staff as Tool Rebels because they puzzle out unusual problem solutions, are always in a good frame of mind and love rock'n'roll. The Tool Rebels have even found a way of portraying themselves on photos and images with very specific greetings and gestures.

The “Tool Rebel Gang” knows no limits. Meanwhile, a lot of customers and users across the world are referring to themselves as Tool Rebels since they love Wera tools, question the status quo themselves and listen to rock music.



[/weratoolrebels](#)

Content

The Krafftform Handle	6	Torque Screwdrivers	36
Krafftform VDE	8	Click-Torque	
Krafftform VDE iS	8	Torque Wrenches	38
The Chiseldriver	10	Safe-Torque	
Krafftform Micro	12	Torque Wrenches	40
Krafftform Stainless	14	Krafftform Kompakt	42
T-handle Screwdrivers	16	Lasertip	44
Krafftform Turbo	18	Take it easy Tool Finder	46
Joker 6000, 6001, 6002	20	Hex-Plus Tools	47
Joker 6003	20	Rapidaptor Technology	48
Joker 6004	22	Impaktor Technology	50
Zyklop Speed Ratchet	24	Diamond-coated Bits	52
Zyklop Metal Ratchet	26	BiTorsion System	53
Zyklop Pocket Ratchet	28	Tools with Holding Function	54
Zyklop Hybrid Ratchet	30	Wera 2go	56
Zyklop Mini Ratchet	32	Textile Boxes	58
Koloss Ratchet	34		



The Kraftform Handle

The basic idea for the prototype of the Kraftform handle – that the hand should dictate the design – has, right through to today, proved to be correct. In cooperation with the internationally recognised Fraunhofer IAO Institute, Wera developed a screwdriver handle designed to match the shape of the human hand as long ago as the 1960s. After a long development phase, the Wera Kraftform handle was launched to the market in 1968. It has been optimised through the years with new technologies, but has kept its proven shape. After all, the human hand has not changed either.

The large contact area – with particularly high friction to the soft zones – results in high torque transfer without any bruising from the edges.

The hard materials used for the handle ensure rapid hand repositioning without any danger of the skin “sticking” to the handle. The surrounding hard zones with large diameters glide like wheels through the hand.

The hexagonal non-roll feature prevents any rolling away at the workplace.





Kraftform VDE

We want our users to be able to work safely and conveniently. So we have transferred the advantages of the Kraftform technology into the VDE segment.

The individual testing in a water bath at 10,000 volts, in accordance with IEC 60900, ensures safe working with loads up to 1,000 volts.

Impact strength tested at -40°C , guaranteeing safety even under extreme conditions.

Kraftform VDE iS

Reduced blade diameter with integrated protective insulation, allows sunken screws and spring elements to be accessed and actuated, individually tested as per IEC 60900.





The Chiseldriver

Screwdrivers are often misused as chisels. This can be dangerous. The chiseldriver is the solution when not only screw-driving is required. For fastening, chiselling and loosening seized screws. Wera chiseldriver: the screwdriver whenever the going gets tough!

A hexagon blade made out of high-quality bit material extends right through the handle – thereby ensuring full transfer of force, even when struck with a hammer. The ductile tempered material prevents the blade from splintering or breaking.

An integrated impact cap lengthens the service life and reduces the danger of splintering. Nevertheless, always wear protective goggles.

Greater torque can be transferred by fitting an open-jaw or ring spanner over the integrated hex bolster.

NEW: Compact and robust interchangeable blade screwdriver set with manually activatable impact wrench function.

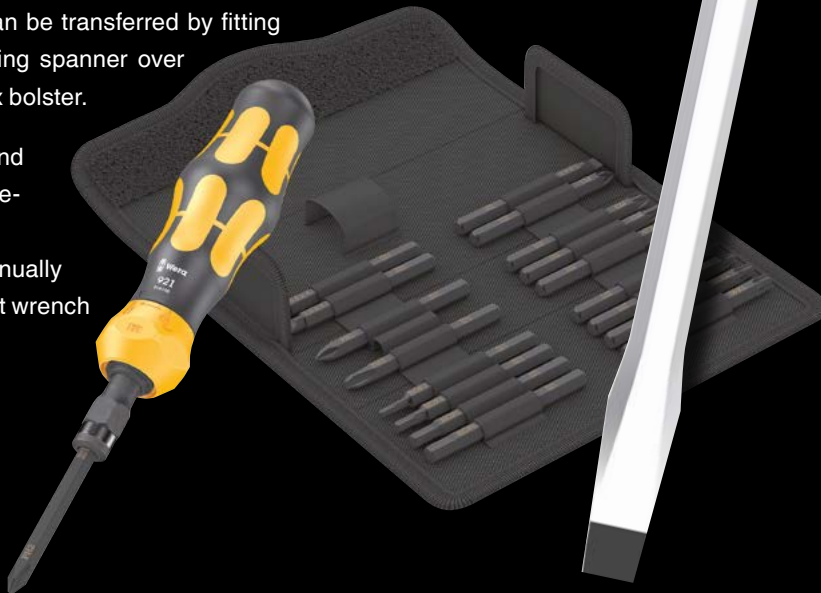



Kraftform Micro

Screwdriving jobs in electrical and precision engineering applications are often tedious and time-consuming. We learned from users what is important for them: working speeds, torque, precision – and we then focused particularly on these issues.

The Kraftform Micro, with its three zones and their specific arrangement, satisfies these requirements perfectly. The free-turning cap that provides support for the hand works with these advantages, enabling quick and easy precision work.

The precision zone directly above the blade gives the user a better feel for the right rotation angle during fine adjustment work.

The power zone has integrated soft zones near the blade tip to ensure high torque transfer for loosening or tightening screws without losing contact with the screw.

The fast-turning zone just below the rotating cap allows rapid twisting.

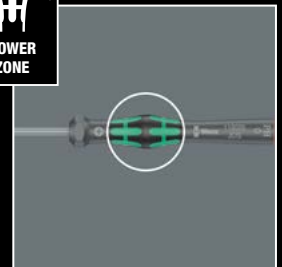
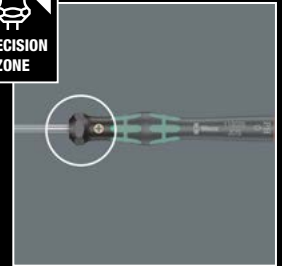
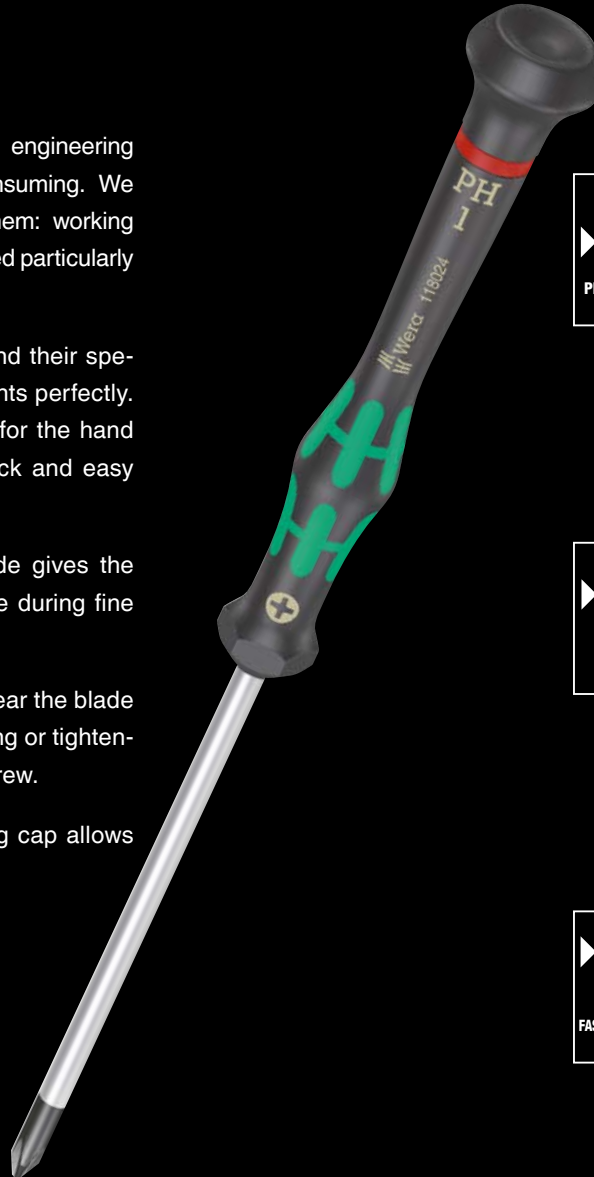



Kraftform Stainless

Why are stainless elements so often affected by rust? One reason: screwdriving jobs are often carried out with a tool made of conventional steel which can result in extraneous rust forming. This is annoying. We were confident that this could be prevented by using tools likewise out of stainless steel and meeting the required standard of industrial hardness.

A tool series out of stainless steel. The forming of extraneous rust is prevented and a special vacuum ice-hardening process ensures the required degree of hardness.

There are no limitations to the industrial applications they are suitable for.





T-handle Screwdrivers

The ideal handle shape makes the transfer of higher tightening and loosening torque possible. The ergonomic design of the handle fills the palm of the hand and the fingers rest in the soft, rounded recesses. The whole hand is in contact with the handle so there is no frictional loss between the hand and the handle. Special surface treatment of the blades for high corrosion protection and optimum fitting accuracy.



416 RA / 411 A RA

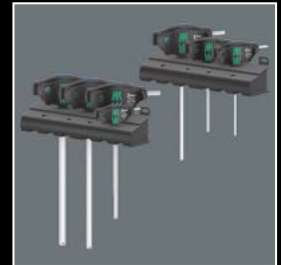

410 i VDE

454/7 HF Set 2



Kraftform Turbo

Many users would like to be able to carry out screwdriving processes faster without compromise. With a screwdriver that is precise, allows powerful screwdriving, and is much faster than a conventional screwdriver. A part-time universal gear is the solution: Integrated in the screwdriver handle, it quadruples the working speed with smooth couplings – purely mechanically.

One hand holds the front part of the handle, the other hand turns the rear part of the handle.

The turbo function can be switched on or off at the push of a button. Turning it off is recommended for tightening and loosening with high torque, e. g. for screw connections in wood, as well as for fine adjustments. Robust, maintenance-free gear made of steel with a maximum torque of 14 Nm when the turbo function is deactivated.

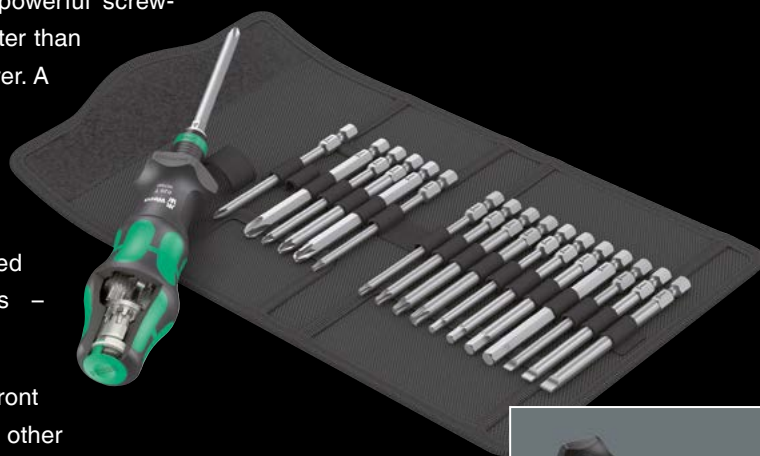

VDE
TOOL

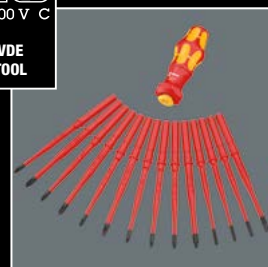



Joker 6000, 6001, 6002

When we began to think about open-ended wrenches, we asked ourselves: why does the wrench always have to be flipped over; why does it have an offset design; why does it slip off injuring fingers? The new design of the mouth resulted in a real “Joker” that works even when all other trumps have been played. The Joker’s holding function means that nuts and bolts can be held in the jaw and easily positioned where they are needed. The Joker prevents slipping off of the fastener head with its integrated limit-stop. The exchangeable, hardened metal gripping plate in the Joker’s mouth literally bites itself into the bolt, with its extremely hard tips. Instead of 60°, the Joker only has a 30° back-pivoting angle thanks to its unique double-hex design. Along with the Joker’s straight neck, this means that flipping the wrench has become a thing of the past.

Joker 6003

The Joker 6003 ring spanner with its special mouth geometry – mouth side pivoted by 7.5° and the double hexagon profile – doubles the placement possibilities when repeatedly turning the wrench 180° around the longitudinal axis. Bolts and screw heads can be “accessed” every 15°. The Joker 6003 will automatically find the respective placement point after every turn.





Joker 6004

Many users wish to have a universal screwdriving tool with the widest possible range of applications. It should be a single tool for multiple metric and imperial dimensions. It should automatically adjust to the different screw sizes. It should be safe to grab without damaging anything and should allow for high working speeds.

The adjustable Joker 6004 is that kind of universal screwdriving tool. With its continuous and parallel jaws the Joker 6004 replaces several single spanner sizes. The required size is automatically and continuously set when attaching the tool to the hexagon bolt or screw.

The integrated lever mechanism securely clamps the hexagon screw or bolt between the jaws, which significantly reduces the risk of slippage or damage. The ratchet feature ensures fast and consistent screwdriving without removing the tool. By using the corner-width rectangular prisms, a back-pivoting angle of only 30° can be achieved. The single-arm design, in conjunction with the ratchet feature and the corner-width prism, makes it possible to work even in confined spaces.

Joker 6004 VDE: Individually tested tools with insulated handles for safe working up to 1,000 volt, with anti-slip protection and sliding function for contactless and safe opening of the non-insulated jaws.

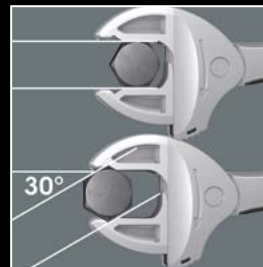
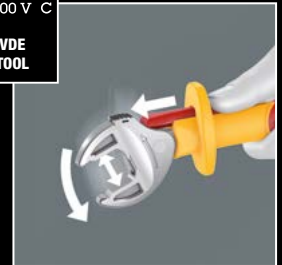



Zyklus Speed Ratchet

We just could not believe that it was not possible to make a ratchet work more quickly. Moreover, we did not like the way users had to apply many different types of ratchet to get a job done. We therefore questioned everything that was conventional about ratchets. The Zyklus Speed ratchet is what has emerged. The flywheel design of the Zyklus Speed ensures high working speeds. And: the Zyklus Speed combines the advantages of 5 types of ratchet in a single tool. Additionally, it can be used as a screwdriver. The ratchet head pivots freely and can be locked into any defined position by using the slide switch that is positioned on either side.

The reversible ratchet with 72 fine-pitched teeth has a low return angle of only 5°. This short stroke allows fast and precise work in all types of installation.

The ball lock holds the sockets and attachments securely, ensuring safe working. A change of tools in any predefined position is completed by simply pressing the release button.

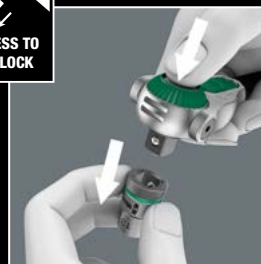
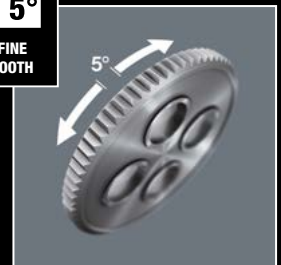

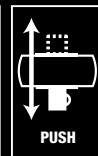

Zyklon Metal Ratchet

Due to the ever-more confined working environment, space is becoming more and more an issue for the application of ratchets. Our product developers therefore intensively occupied themselves

with the issue of confined working spaces, and Wera has now solved this problem. The extremely slim and robust Zyklon Metal ratchet with a long lever was what emerged. When the change in direction needs to be quick, the Zyklon Metal Switch ratchet is the right tool. When the socket must not get lost and a coincidental change of direction has to be avoided at all cost, the Zyklon Metal Push is the correct choice.





Zyklus Pocket Ratchet

Zyklus Pocket ratchet with integrated bit magazine and combination mounting for bits and sockets. A captive, freely swivelling bit magazine for 12 bits ($\frac{1}{8}$ " 25 mm length) is integrated in the handle of the compact ratchet. The magnetic direct mounting is suitable for $\frac{3}{8}$ " sockets as well as $\frac{1}{4}$ " bits. The fine toothing with 72 teeth allows for a low return angle of only 5° for working in constricted screwdriving situations. Thanks to the sliding switch on both sides, the ratchet head can be locked at the pre-defined positions 0° as well as 15° and 90° to the right and left. The Zyklus Pocket ratchet can be quickly and easily reversed for clockwise/counterclockwise rotation in any position using the knurl. The robust holster can be attached to the belt.





Zyklus Hybrid Ratchet

We wanted to integrate all the mostly-desired ratchet advantages in a single tool. Our idea was to develop a light ratchet with an ergonomic handle, slim design, long lever and an extension option. Since the term “hybrid” refers to a combination from various sectors, it was quite easy to decide on the name.

Multi-component Kraftform handle for optimum pressure and tensile loads.





Zyklop Mini Ratchet

Combines elegant design with incredible resilience.

The Mini ratchets for all difficult-to-access applications. The Zyklop Mini can withstand at least 65 Nm. That is far more power than can normally be transferred to such a small tool. The fine tooth mechanism, with its 60 teeth, allows a small return angle of only 6° – ideal for precision work.

High working speeds can be attained with the Zyklop Mini 1 bit ratchet. The thumb wheel is important, enabling more rapid screwdriving, and the lever of the Zyklop Mini only needs to be used for the final tightening of the screw.

The Zyklop Mini 1 allows particularly quick screwdriving, even in narrow work situations. With direct bit mounting. With the Wera 870/1 adapter (1/4"-hexagon to 1/4"-square head), 1/4" sockets can also be operated.

The Zyklop Mini 2 is suitable for the direct attachment of the special Wera Zyklop sockets 8790 FA (with 1/4" and hex drive). These sockets feature a very low height, ideal for confined working spaces.

The Wera Zyklop Mini 3 ratchet is suitable for 1/4" sockets. The knurled wheel allows fast screwdriving in tight spaces when there is no room for ratcheting. Simple left/right switching.





Koloss Ratchet

Obviously, many users also use their ratchet as a hammer. This often ruins the ratchet and is dangerous to boot. That is why we developed the heavy-duty Koloss ratchet whose mechanism is extremely robust, and nearly impossible to destroy through impact. The Koloss is so robust that it can even be used safely with its extension element. With dual ratchet teeth. Gives the robust 30 saw teeth the precision engineering effect of 60 fine teeth with a 6° return angle.

Changing the ratchet direction using a hardened push-through square drive ensures great resilience, since there is no susceptible switching mechanism that could be damaged by hammer blows. This is far more robust than a right/left switch. Newly developed, multi-component Kraftform handle that satisfies both the hammer and ratchet application requirements. The degree of torque applied can be increased by using the Wera extension Koloss 8002 C.

Typical fields of application are mechanical engineering, boatbuilding, mining, aircraft construction, bridge building, commercial vehicle construction and maintenance, railway and road construction and maintenance, industrial plant and equipment construction, high-bay warehouse construction, petroleum industry and many more.

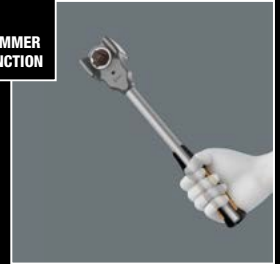
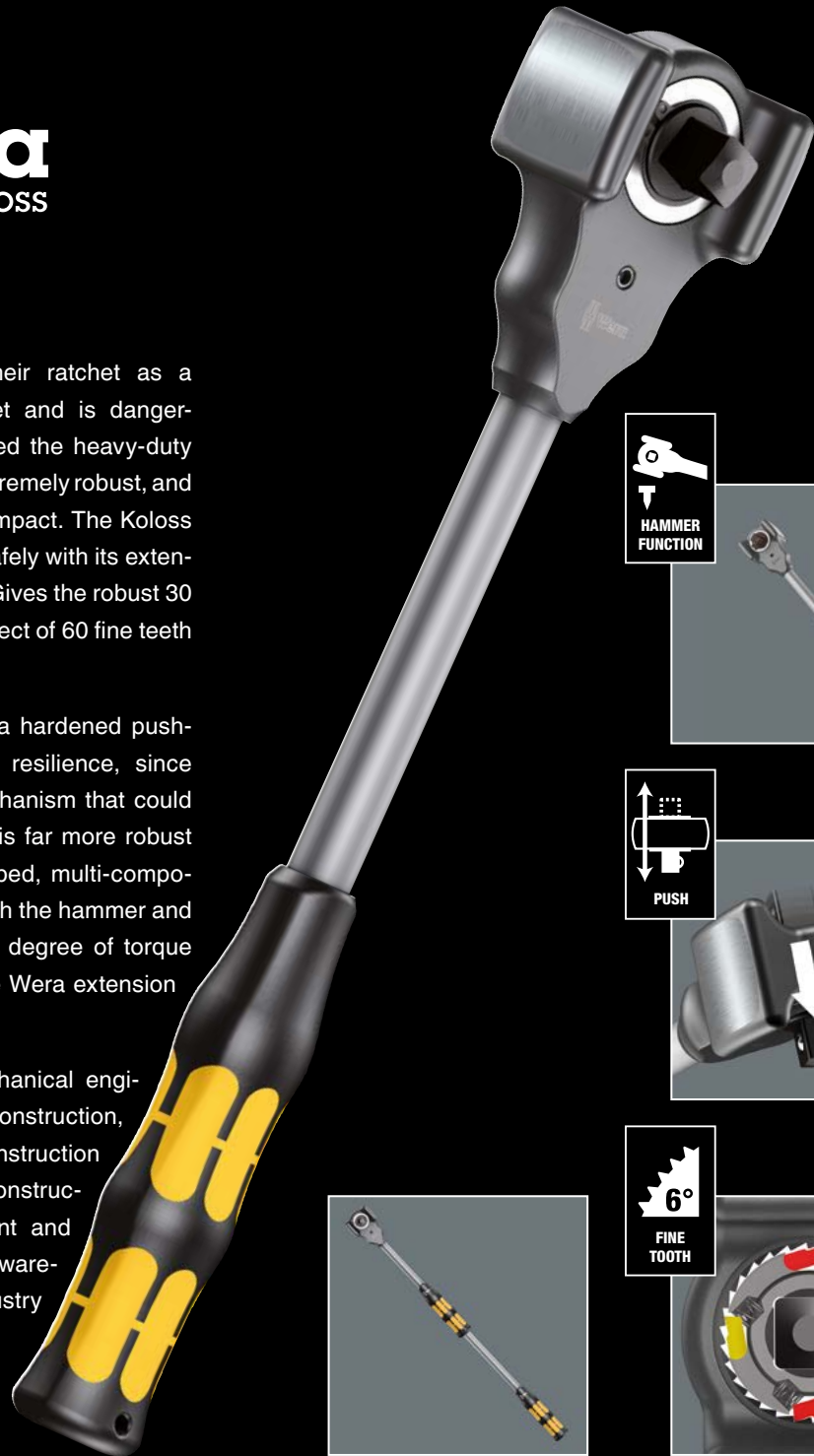



Torque Screwdrivers

Over-tightening a fastener can result in stripping screws and snapping screw heads. If a screw is not properly tightened various damages can be the consequences. We want to help our users to avoid situations like that.

Wera's adjustable torque screwdrivers allow variable torque settings with maximum precision and ensure that the user gets the very best results in the familiar Wera design with superior ergonomics.

Wera torque screwdrivers with a factory pre-set torque value set to the smallest scale value are ideal for all applications, where the same constant torque and repeat accuracy are required.

Some screw connections require specific torque values so that they can be tightened or loosened easily. Wera torque-indicators are pre-set to torque values recommended by leading carbide tool manufacturers.

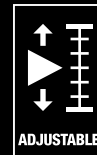
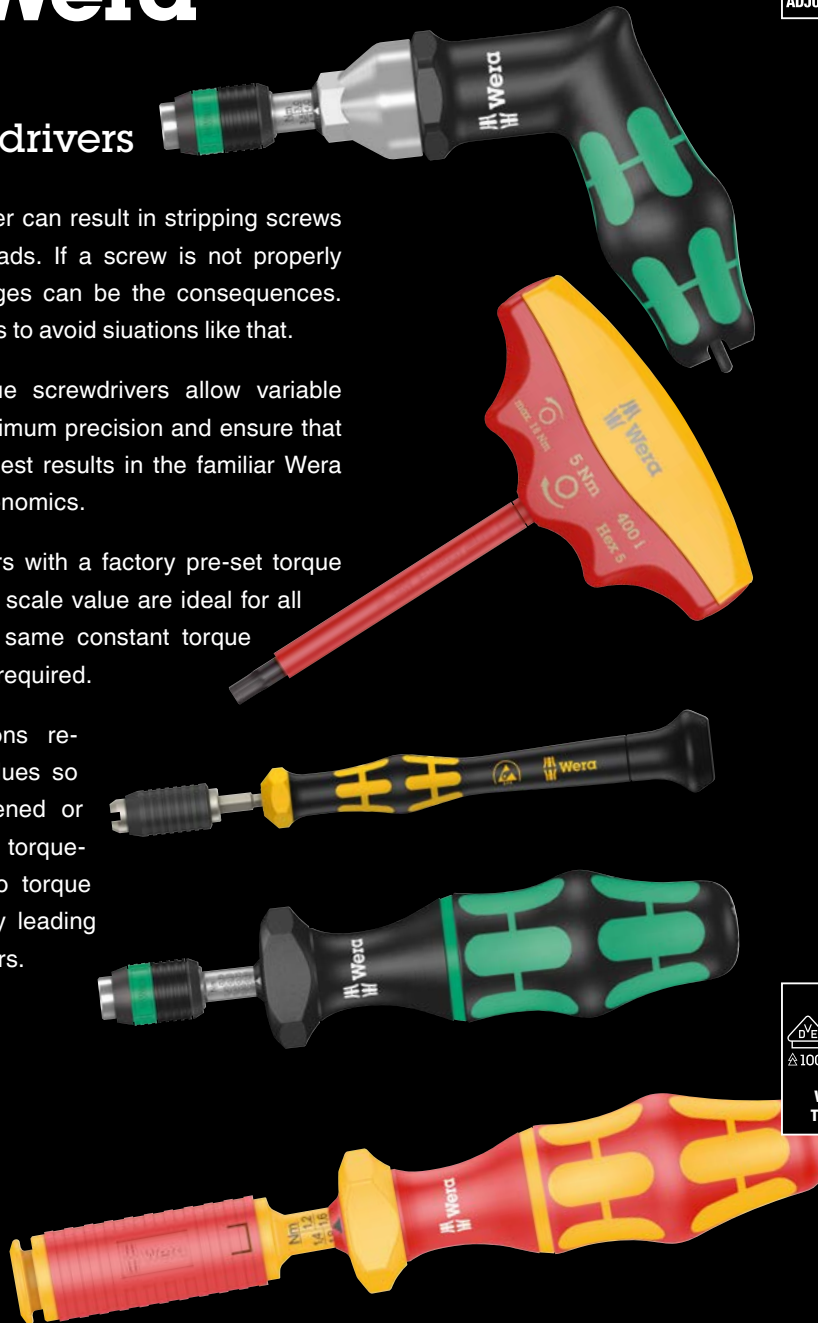

ADJUSTABLE





Click-Torque Torque Wrenches

We wanted working with torque wrenches to be simple and accurate – which is why we developed the Click-Torque wrenches. With the ability to set and save the default values and with the unmistakable, robust Wera design, these torque wrenches are the ideal tools for all bolting applications that require torque-controlled tightening (clockwise torque wrenches) and tightening and loosening (torque wrenches for insert tools).

The Click-Torque wrenches are available for clockwise torque-controlled tightening with a reversible ratchet ($\frac{1}{4}$ " , $\frac{3}{8}$ " , $\frac{1}{2}$ " and $\frac{3}{4}$ " drive) or for insert tools (9x12 mm, 14x18 mm) for torque ranges from 2.5 Nm to 1000 Nm.

The reversible Click-Torque wrenches are for clockwise use, the Click-Torque wrenches for insert tools are suitable for clockwise and counterclockwise use.

The Click-Torque XP torque wrenches with a pre-set torque value can be set to any value within the specified metered range in the test laboratory.

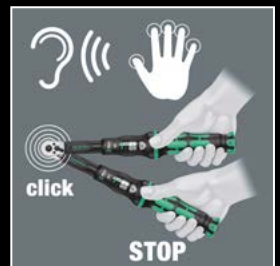
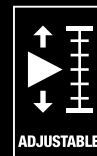
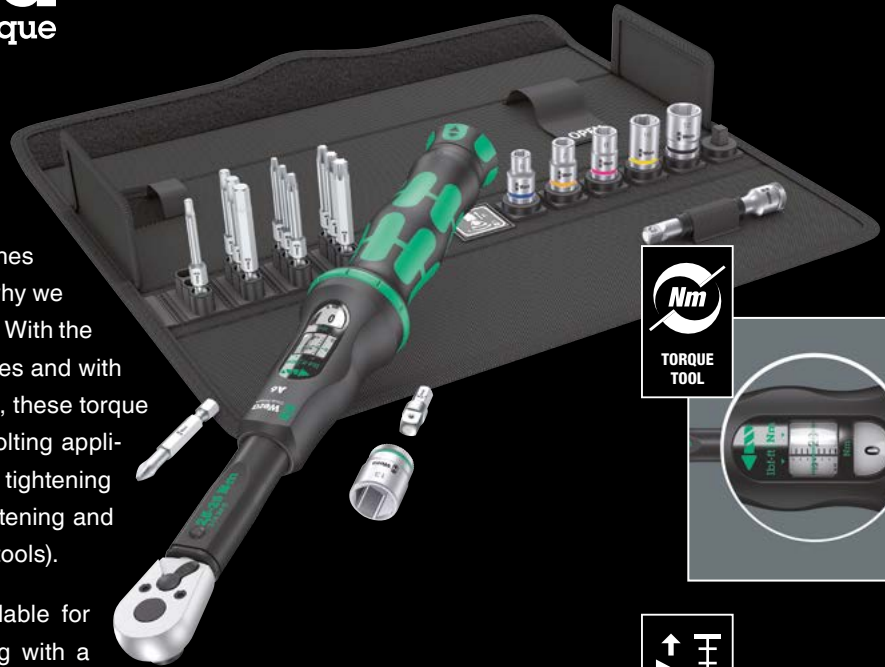



Safe-Torque Torque Wrenches

The torque wrench that cannot be over-tightened, with deactivation setting to use as a ratchet.

The Safe-Torque torque wrench is equipped with a slide-over mechanism. Once the set torque value has been reached, the tool cannot be overtightened, so that excessive torque cannot be applied. Easy setting and saving of the desired torque value with audible and tactile clicks when reaching the scale values. The ball lock ensures secure seating of the sockets and accessories and therefore also reliable safety during screwdriving. A short press on the release button on the ratchet head and the ball lock is released. The Safe-Torque torque wrench is suitable for clockwise and counterclockwise operation with a set torque. When the Torque Lock function is deactivated, tightening and loosening is enabled without torque. The Safe-Torque torque wrench can then also be used as a standard ratchet with high loosening moments and for applications with defined angles of rotation. The fine-toothed Safe-Torque torque wrench with 72 teeth has a back-pivoting angle of only 5°. The small stroke offers quick and precise working in all installation positions.

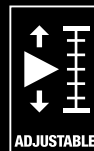
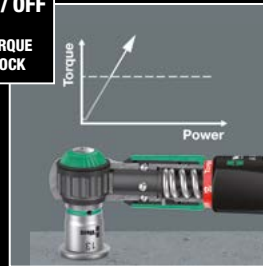

Kraftform Kompakt

Why is the right tool so often not at hand? The reason: too many tools and overly-heavy tool bags can make it bothersome to carry them onsite. So for us it was a clear challenge: to design a tool that is suitable for a whole host of applications and can be easily taken along to jobs at other sites. Our solution: Kraftform Kompakt tools. A handle into which inter-changeable blades with a range of different profiles can be inserted. Compactly and protectively housed in a light and robust textile pouch or plastic box.

The Kraftform Kompakt VDE sets have been tested individually at 10,000 volts, in accordance with IEC 60900. This ten-times-higher testing load guarantees safe working at their maximum permitted load of 1,000 volts.

Kraftform Kompakt user ranges – the new special sets – compact yet very versatile. Suitable for all sanitary, wood, metal or electrical applications.

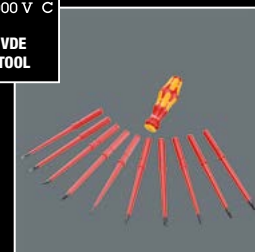
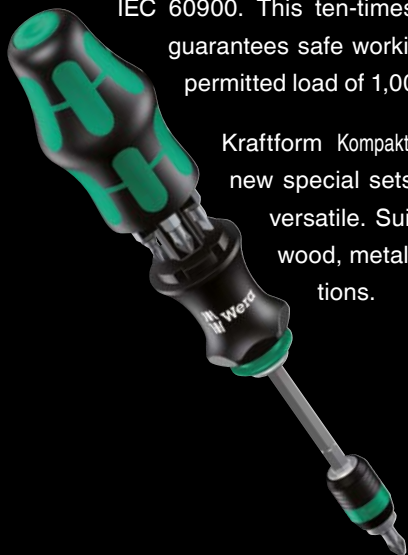



Lasertip

We want to make our users' lives easier and safer. They should have fun too. But when slipping out of a screw and leaving scratches on the surface with a screwdriver, it's anything but fun. We wanted to change that.

The tips of the Wera Lasertip screwdrivers are microscopically roughened by means of a laser. This rough surface literally "bites" itself firmly into the screw head. Slipping out becomes a thing of the past.

Wera Lasertip reduces the contact pressure required and enhances force transfer – meaning less screwdriving effort is required. Screwdriving becomes safer and easier.

Lasertip is available for screwdrivers for slotted, Phillips and Pozidriv screws.

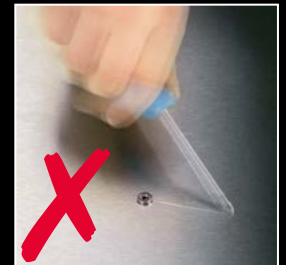



Take it easy Tool Finder

Take it easy tool finder with colour coding according to profiles and size stamp – for simple and rapid accessing of the required tool.

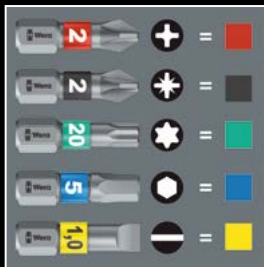

Hex-Plus Tools

We questioned the classic L-key design, since all too often the screw head recess of hexagon socket screws is rounded out, meaning screws can no longer be tightened or loosened – and so the user finds the L-key slipping out of the recess.

Wera Hex-Plus tools have a larger contact surface in the screw head. The notching effects are reduced and thereby the deformation of the screws is reduced. At the same time, as much as 20 % more torque can be applied.

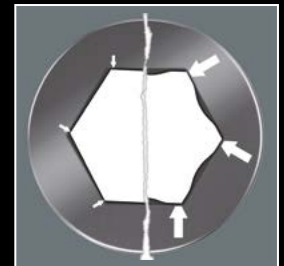
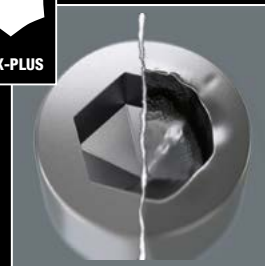



Rapidaptor Technology

We were not happy that bit change with bit holders was often quite cumbersome. We found out that strong magnets or retaining rings indeed hold the bit securely, but they greatly impede removal from the holder.

So we have developed bit holders that reliably hold the bit, yet still allow for fast and trouble-free bit change. The solution: bit holders with quick-release mechanisms that lift the bit from the magnets. Bit holders which – depending on the requirements – additionally have elastic zones that absorb peak loads. Or rapid-spin sleeves with which the cordless or electric screwdrivers can be guided during the screwdriving process.

Rapidaptor bit holder: Rapid bit change without needing any additional tools. One-hand operation with a freely spinning sleeve for simplified guidance of the tool. Also available in a BiTorsion design.

Rapidaptor with ring magnet: Special design powerful ring magnet, for larger and heavier screws. Ideal for overhead work, too.





Impaktor Technology

We were not too happy that disintegrating bits flew around users faces as screwdriving with power tools took place with ever-higher power outputs. We scrutinised the geometry and material properties of the bits for every screw profile. We analysed the destroyed bits, holders and screws in detail. The result is the Impaktor system – our entire know-how from bit manufacturing combined in our very best bit series.

The Wera 2go tool container is the ideal solution for individual and convenient tool transport thanks to its hook and loop fastener system and its compactness. The inner and outer hook and loop fastener zones ensure a maximum in terms of space utilisation. This means that an incredible number of tools can fit in and on the container.

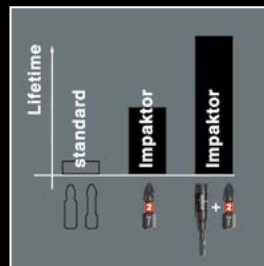



Diamond-coated Bits

One of the greatest problems with power tool applications is that the conventional bit easily slips out of the head of the screw (cam-out). This often destroys both the head of the screw and the tool.

High resulting costs are incurred e.g. from damaged surfaces and screw connections that can no longer be loosened. Screwdriving will become safer and more economic if this problem of slipping can be minimised.

The diamond coating of the bits lowers the danger of slipping as the minute diamond particles literally “bite” themselves into the screw head.

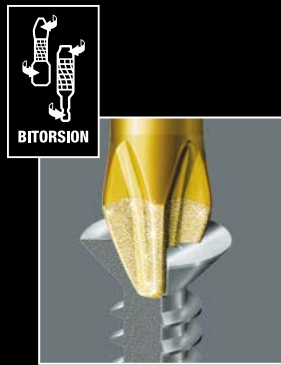

BiTorsion System

The effectiveness of the BiTorsion system comes from a combination of two shock-absorbing spring elements. Both, bits as well as holders have a cushioning torsion zone that diverts the kinetic energy away from the drive tip during peak loads.

The torsion spring integrated into the unique BiTorsion holder absorbs lower levels of peak loads (phase 1). Any overloading of this spring is effectively prevented by means of a supporting mechanism.

Higher peak loads are minimised through the torsion effect of the bit shaft (phase 2).

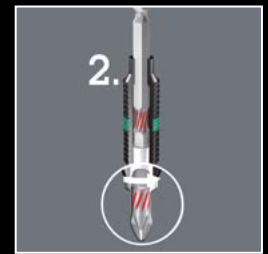
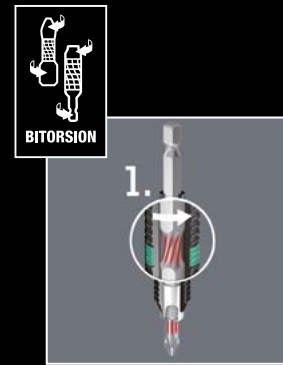



Tools with Holding Function

The holding function holds screws securely on the tool. This is particularly helpful in difficult-to-access working spaces where the second hand cannot be used to hold the screw.

The **TORX® HF** tools developed by Wera are ideal because they feature an optimised geometry of the original TORX® profile. The wedging forces resulting from the surface pressure between the drive tip and the screw profile mean that TORX® screws made according to Acument Intellectual Properties specifications are securely held on the tool!

A resilient ball ensures the **hexagon socket screw** to be clamped on the tool tip.

The clamping of **hexagon headed bolts, screws and nuts** is achieved by a twin spring loaded ball retention system. The tubing is effectively protected against mechanical wear and tear by a steel ring.

Zyklop sockets and bit sockets with holding function securely hold the screw on the tool.

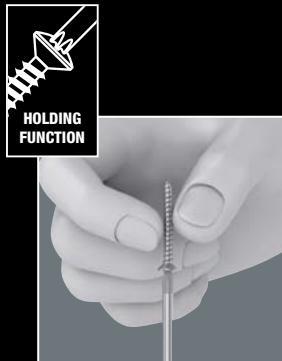



Wera 2go

We wanted our textile boxes and pouches to be light-weight mobile partners for the users, who are more and more often out and about with their tools and toil with too heavy toolboxes. We were looking at the same time for a solution which leaves the hands free and with which tools can easily be docked and undocked as needed.

The Wera 2go tool container is the ideal solution for individual and convenient tool transport thanks to its hook and loop fastener system and its compactness. The inner and outer hook and loop fastener zones ensure a maximum in terms of space utilisation. This means that an incredible number of tools can fit in and on the container.



Wera packaging bearing this symbol contains tool pouches or textile boxes with nonwoven sections that can be docked with the Wera 2go system.





Textile Boxes

The textile boxes offer dramatically improved portability, and are space-saving to boot! This means you can now carry the same collection of tools, in a much more compact and comfortable package. The hassle of running back and forth for the right tools has now become a thing of the past. And the much lower weight of a set makes carrying more convenient than ever before.

The textile box including the tool will even survive a fall undamaged.

The textile boxes and pouches feature a fleece zone at the back. Using the provided self-adhesive hook and loop fastener strips, they can be attached to the Wera 2Go components. Or to the wall, shelf or roller cabinet.

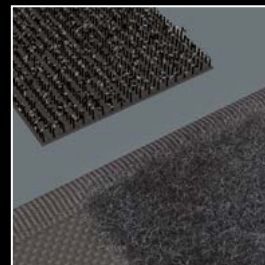



/weratoolrebels



Wera

Wera Tools (UK) LTD.

Railway View
Clay Cross
Chesterfield
Derbyshire, S45 9FR
+44 (0)1246 / 277756
queries@weratools.co.uk

Wera Tools Inc.

3325 Harvester Rd, Unit 16
Burlington, ON
L7N 3N2
Canada
+1-800-267-5541
info@weratools.com

Wera Werkzeuge GmbH

Korzerter Str. 21-25
42349 Wuppertal
Germany
www.wera.de
+49 (0)202/40 45-0
info@wera.de

Wera Tools Australia Pty Ltd.

Mike Sack
Australia
+61-435-755-123
mike.sack@wera.de

Wera Tools Japan G.K.

Frank Yang
Japan
+81-3-3915-2555
frank.yang@wera.de

EN 05 510314 001 - 0053701 - 02

